

ESTOJOS COM SEPARADORES FIXOS E AMOVÍVEIS
BOXES WITH FIXED AND MOBILE DIVIDERS

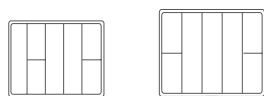

 **Material:** polipropileno
Caixa: transparente
Ferramenta não incluída

 **Material:** polypropylene
Box: transparent
Tools not included



12004001

12006005

REF.	MODELO/ MODEL	MEDIDAS/ SIZES	
12004001	23-1	160 x 122 x 30 mm	24
12006005	25-1	178 x 140 x 34 mm	24



12012006

12013003

12014000

12010002

12011009

REF.	MODELO/ MODEL	MEDIDAS/ SIZES	
12012006	170-7	170 x 114 x 36 mm	12
12013003	240-12	240 x 155 x 41 mm	12
12014000	300-16	300 x 199 x 46 mm	6
12010002	450-25	387 x 230 x 49 mm	6
12011009	500-25	440 x 244 x 49 mm	6

A 10 separadores amovíveis/ mobile dividers

ESTOJOS COM SEPARADORES FIXOS
BOXES WITH FIXED DISTRIBUTION



 **Material:** polipropileno
Base: verde **Tampa:** transparente
Ferramenta não incluída

 **Material:** polypropylene
Base: green **Cover:** transparent
Tools not included



12050107

12051104

12060106

12061103

REF.	MODELO/ MODEL	MEDIDAS/ SIZES	
12050107	11-12	250 x 140 x 54 mm	6
12051104	11-7	250 x 140 x 54 mm	6
12060106	12-21	290 x 195 x 54 mm	6
12061103	12-11	290 x 195 x 54 mm	6

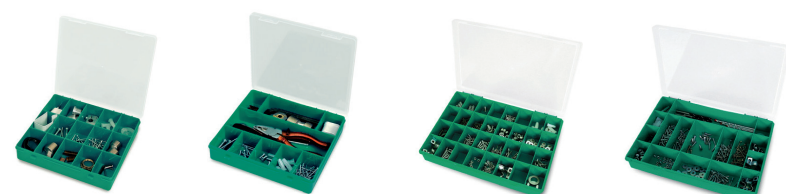

12008009

12009006

12070105

12071102

REF.	MODELO/ MODEL	MEDIDAS/ SIZES	
12008009	33-15	215 x 207 x 42 mm	12
12009006	33-9	215 x 207 x 42 mm	12
12070105	13-32	330 x 247 x 54 mm	6
12071102	13-17	330 x 247 x 54 mm	6

MALAS PARA FERRAMENTAS (COLEÇÃO BÁSICA)
BASIC COLLECTION TOOL BOXES



Material: polipropileno
Base: preto
Tampa: transparente

Material: polypropylene
Base: black
Cover: transparent

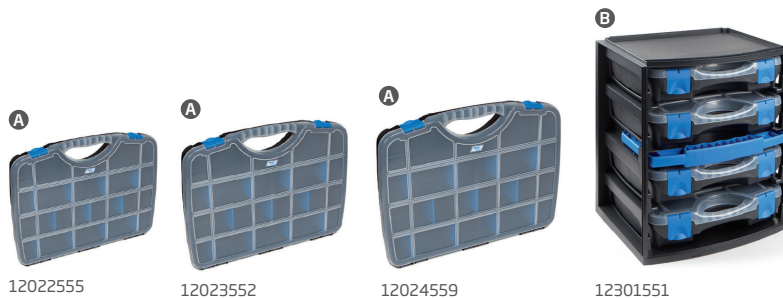

REF.	MODELO/ MODEL	MEDIDAS/ SIZES	
12022555	AccessoryBox 01	312 x 238 x 51 mm	6
12023552	AccessoryBox 02	388 x 290 x 61 mm	6
12024559	AccessoryBox 03	460 x 350 x 81 mm	5
12301551	Multibox n°1	335 x 250 x 275 mm	2

- A** 21 separadores amovíveis/ mobile dividers
- B** Módulo com asa/ Module with handle + 4 Malas/ Boxes Ref. 12022555

ESTOJOS COM SEPARADORES AMOVÍVEIS
BOXES WITH MOBILE DIVIDERS



Material: polipropileno
Base: azul/ *cinza **Tampa:** transparente
Ferramenta não incluída

Material: polypropylene
Base: blue/ *grey **Cover:** transparent
Tools not included



REF.	MODELO/ MODEL	MEDIDAS/ SIZES	
12145001	45-26	312 x 238 x 51 mm	6
12146008	46-26	378 x 290 x 61 mm	6
12147005	47-26	460 x 350 x 81 mm	5
12148002	48-26	460 x 350 x 81 mm	5
12049002	49-16	490 x 250 x 80 mm	5

- A** 21 separadores amovíveis/ mobile dividers
- B** 12 separadores amovíveis/ mobile dividers
- C** Tampa policarbonato/ polycarbonate cover

ESTOJOS COM SEPARADORES FIXOS E AMOVÍVEIS
BOXES WITH FIXED AND MOBILE DIVIDERS



Material: polipropileno
Base: verde **Tampa:** transparente
Ferramenta não incluída

Material: polypropylene
Base: green **Cover:** transparent
Tools not included



REF.	MODELO/ MODEL	MEDIDAS/ SIZES	
12020001	20-9	190 x 150 x 42 mm	12
12021008	21-10	256 x 192 x 42 mm	12
12022005	22-26	312 x 238 x 51 mm	6
12023002	23-26	388 x 290 x 61 mm	6
12024009	24-26	460 x 350 x 81 mm	5

- A** 21 separadores amovíveis/ mobile dividers

MULTIBOX MULTIBOX



Material: polipropileno

Material: polypropylene



12301001

12302008

REF.	MODELO/ MODEL	MEDIDAS/ SIZES	
12301001	Multibox nº1	335 x 250 x 275 mm	2
12302008	Multibox nº2	447 x 314 x 360 mm	2

A Módulo com asa/ Module with handle + 4 Malas/ Boxes Ref. 12022555

B Módulo com asa/ Module with handle + 4 Malas/ Boxes Ref. 12023002

ESTOJOS COM CAIXAS REMOVÍVEIS 50 BOXES WITH REMOVAL DRAWERS 50



Base: polipropileno preto
Tampa: poliestireno transparente
Caixas: poliestireno vermelho
Ferramenta não incluída

Base: black polypropylene
Cover: transparent polystyrene
Boxes: red polystyrene
Tools not included

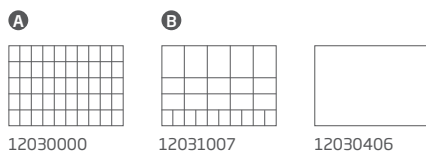

12030000

12031007

12030406

REF.	MODELO/ MODEL	MEDIDAS/ SIZES	
12030000	430/50/50	430 x 370 x 55 mm	4
12031007	430/50/25	430 x 370 x 55 mm	4
12030406	430/50/0	430 x 370 x 55 mm	4

CAIXAS REMOVÍVEIS/ REMOVABLE DRAWERS

REF.	MODELO/ MODEL	MEDIDAS/ SIZES	
12040009	A50	55 x 39 x 47 mm	300
12041006	B50	79 x 55 x 47 mm	150
12042003	C50	109 x 79 x 47 mm	75

A Caixas/ boxes: 50 x A50 **B** Caixas/ boxes: 10 x A50, 10 x B50, 5 x C50

ESTOJOS COM CAIXAS REMOVÍVEIS 80 BOXES WITH REMOVAL DRAWERS 80



Tampa: poliestireno transparente
Caixas: poliestireno vermelho
Ferramenta não incluída

Base: black polypropylene
Cover: transparent polystyrene
Boxes: red polystyrene
Tools not included

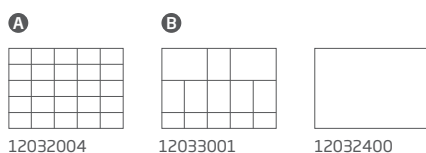

12032004

12033001

12032400

REF.	MODELO/ MODEL	MEDIDAS/ SIZES	
12032004	430/80/25	430 x 370 x 85 mm	4
12033001	430/80/13	430 x 370 x 85 mm	4
12032400	430/80/0	430 x 370 x 85 mm	4

CAIXAS REMOVÍVEIS/ REMOVABLE DRAWERS

REF.	MODELO/ MODEL	MEDIDAS/ SIZES	
12043000	B80	79 x 55 x 76 mm	90
12044007	C80	109 x 79 x 76 mm	45
12045004	D80	157 x 109 x 76 mm	21

A Caixas/ boxes: 25 x B80 **B** Caixas/ boxes: 5 x B80, 6 x C80, 2 x D80

ESTOJOS COM CAIXAS REMOVÍVEIS BOXES WITH REMOVAL DRAWERS

 **Base:** polipropileno preto
Tampa: polipropileno transparente
Caixas: poliestireno vermelho
Ferramenta não incluída

 **Base:** black polypropylene
Cover: transparent polypropylene
Boxes: red polystyrene
Tools not included



REF.	MODELO/ MODEL	MEDIDAS/ SIZES	
12034008	330/50/32	330 x 247 x 54 mm	6
12035005	330/50/16	330 x 247 x 54 mm	6
12034404	330/50/0	330 x 247 x 54 mm	6

A Caixas/ boxes: 32 x A50 **B** Caixas/ boxes: 8 x A50, 4 x B50, 4 x C50

CAIXAS PARA O LAR BOXES HOME COLLECTION

 **Material:** polipropileno
Cor: azul ou rosa
Capacidade: 30 Lt.

 **Material:** polypropylene
Color: blue or pink
Capacity: 30 Lt.



12416590

12417597

REF.	MODELO/ MODEL	MEDIDAS/ SIZES	
12416590	Home collection	392 x 399 x 330 mm	5
12417597	Home collection	392 x 399 x 330 mm	5

CAIXAS PARA O LAR BOXES WITH MOBILE DIVIDERS HOME COLLECTION

 **Material:** polipropileno
Base: transparente e acessórios azuis

 **Material:** polypropylene
Base: transparent and blue accessories



12022593

12023590

REF.	MODELO/ MODEL	MEDIDAS/ SIZES	
12022593	22	312 x 238 x 51 mm	6
12023590	23	388 x 290 x 61 mm	6

A 21 separadores amovíveis/ mobile dividers

CAIXAS PARA O LAR BOXES HOME COLLECTION

 **Material:** polipropileno
Base: transparente e acessórios azuis

 **Material:** polypropylene
Base: transparent and blue accessories



12110597

12111594

12112591

REF.	MODELO/ MODEL	MEDIDAS/ SIZES	
12110597	12"	290x170x127 mm	10
12111594	14"	356x192x150 mm	6
12112591	16"	400x217x166 mm	6

A Inclui bandeja/ tray included

MALAS PARA FERRAMENTAS ELÉCTRICAS
CASES FOR ELECTRICAL TOOLS

 **Material:** polipropileno azul
Ferramenta não incluída

 **Material:** blue polypropylene
Tools not included



REF.	MODELO/ MODEL	MEDIDAS/ SIZES	
12140006	40	385 x 330 x 130 mm	7
12141003	41	385 x 330 x 130 mm	7

A Inclui estojo vermelho/ red box included

MALA PARA FERRAMENTAS MANUAIS
CASE FOR MANUAL TOOLS

 **Material:** polipropileno
Caixa: azul
Tampa: transparente
Ferramenta não incluída

 **Material:** polypropylene
Box: blue
Cover: transparent
Tools not included





REF.	MODELO/ MODEL	MEDIDAS/ SIZES	
12142000	42	385 x 330 x 130 mm	7

A Inclui bandeja amarela/ yellow tray included

MALA PARA FERRAMENTAS (COLEÇÃO BÁSICA)
BASIC COLLECTION TOOL BOX



 **Material:** polipropileno
Base: preto
Tampa: transparente
Ferramenta não incluída

 **Material:** polypropylene
Base: black
Cover: transparent
Tools not included



REF.	MODELO/ MODEL	MEDIDAS/ SIZES	
12143557	Power tools 43	401 x 352 x 156 mm	6

A 20 separadores amovíveis/ mobile dividers

MALA PARA FERRAMENTAS ELÉCTRICAS
CASE FOR ELECTRICAL TOOLS

 **Material:** polipropileno
Base: azul
Tampa: transparente
Ferramenta não incluída

 **Material:** polypropylene
Base: blue
Cover: transparent
Tools not included



REF.	MODELO/ MODEL	MEDIDAS/ SIZES	
12143007	43	401 x 352 x 156 mm	6

A 20 separadores amovíveis/ mobile dividers

MALA PARA FERRAMENTAS MANUAIS CASE FOR MANUAL TOOLS

 Material: polipropileno
Caixa: preto
Ferramenta não incluída

 Material: polypropylene
Box: black
Tools not included



12144004

12144998

REF.	MODELO/ MODEL	MEDIDAS/ SIZES	
12144004	44	430 x 370 x 140 mm	4
12144998	44-B	430 x 370 x 140 mm	4

A Inclui bandeja vermelha/ red tray included

MALAS DE PLÁSTICO PARA FERRAMENTAS PLASTIC TOOL BOXES



 Material: polipropileno
Caixa: azul
Ferramenta não incluída

 Material: polypropylene
Box: blue
Tools not included

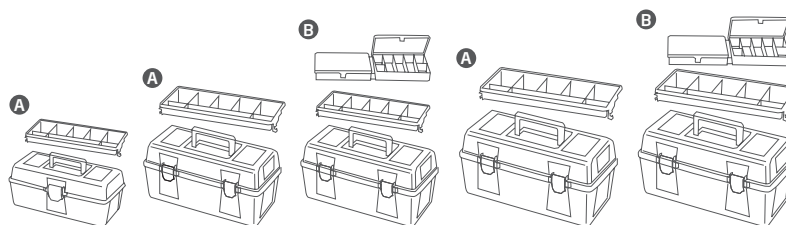

12121005

12122002

12123009

12124006

12125003

REF.	MODELO/ MODEL	MEDIDAS/ SIZES	
12121005	21	310 x 160 x 130 mm	10
12122002	22	356 x 184 x 163 mm	6
12123009	23	356 x 184 x 163 mm	6
12124006	24	400 x 206 x 188 mm	6
12125003	25	400 x 206 x 188 mm	6

A Inclui bandeja vermelha/ red tray included

B Inclui bandeja vermelha e estojo transparente/ red tray and transparent box included

MALA PARA FERRAMENTAS (COLEÇÃO BÁSICA) BASIC COLLECTION TOOL BOX



 Material: polipropileno
Cor: azul e preto
Contém 1 bandeja
Ferramenta não incluída

 Material: polypropylene
Color: blue and black
1 tray included
Tools not included



12110559

12112553

12115554

REF.	MODELO/ MODEL	MEDIDAS/ SIZES	
12110559	ToolBox 12"	290 x 170 x 127 mm	10
12112553	ToolBox 16"	400 x 217 x 166 mm	6
12115554	ToolBox 20"	500 x 258 x 255 mm	3

MALAS DE PLÁSTICO PARA FERRAMENTAS
PLASTIC TOOL BOXES



Material: polipropileno
Caixa: azul
Ferramenta não incluída

Material: polypropylene
Box: blue
Tools not included

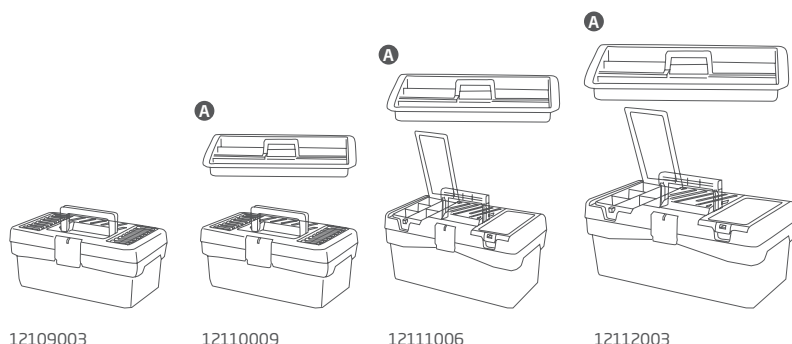

12109003

12110009

12111006

12112003

REF.	MODELO/ MODEL	MEDIDAS/ SIZES	
12109003	9	290x170x127 mm	10
12110009	10	290x170x127 mm	10
12111006	11	356x192x150 mm	6
12112003	12	400x217x166 mm	6

A Inclui bandeja vermelha/ red tray included

MALAS DE PLÁSTICO PARA FERRAMENTAS
PLASTIC TOOL BOXES



Material: polipropileno
Caixa: azul
Fechos metálicos
Ferramenta não incluída

Material: polypropylene
Box: blue
Metalic locks
Tools not included

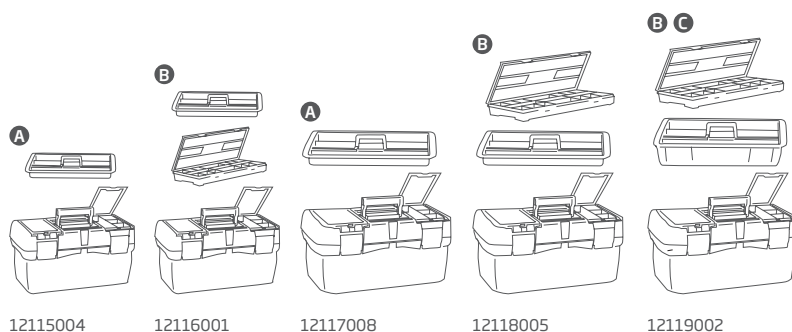

12115004

12116001

12117008

12118005

12119002

REF.	MODELO/ MODEL	MEDIDAS/ SIZES	
12115004	15	500x258x255 mm	3
12116001	16	500x258x255 mm	3
12117008	17	580x290x290 mm	3
12118005	18	580x290x290 mm	3
12119002	19	580x290x290 mm	3

A Inclui bandeja vermelha/ red tray included

B Inclui bandeja vermelha e estojo transparente/ red tray and transparent box included

C Bandeja com o dobro da capacidade/ tray with double capacity

OPÇÃO DE PALETE
BOX - PALET OPTION

24 Un.

Medidas/sizes:
1000 x 772 x 1016 mm
(modelo/model 15/16)
1160 x 804 x 1160 mm
(modelo/model 17/18/19)

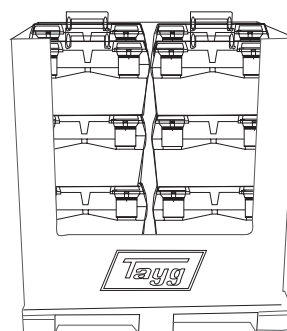

MALAS DE PLÁSTICO PARA FERRAMENTAS
PLASTIC TOOL BOXES





 **Material:** polipropileno
Cor: preto e vermelho

 **Material:** polypropylene
Color: black and red

REF. 12149009
2,25€

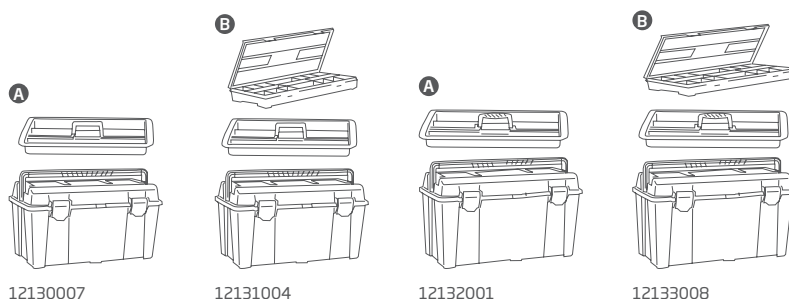
Cinta p/ malas
Strap and Frame for boxes



REF.	MODELO/ MODEL	MEDIDAS/ SIZES	
12130007	30	445x235x230 mm	6
12131004	31	445x235x230 mm	6
12132001	32	480x258x255 mm	3
12133008	33	480x258x255 mm	3

- A** Inclui bandeja vermelha/ red tray included
B Inclui bandeja vermelha e estojo vermelho/transparente/ red tray and red/transparent box included

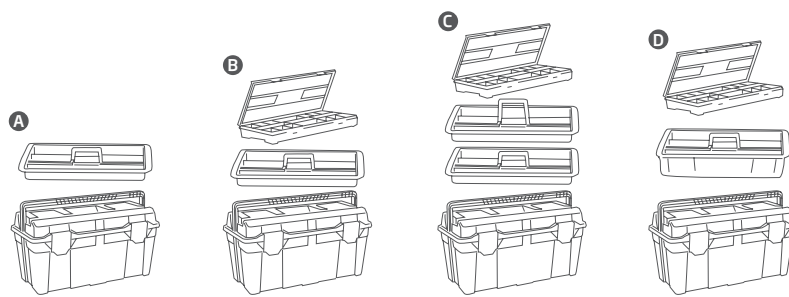

REF.	MODELO/ MODEL	MEDIDAS/ SIZES	
12134999	34-1B	580x285x290 mm	3
12134005	34	580x285x290 mm	3
12135002	35	580x285x290 mm	3
12136009	36	580x285x290 mm	3

- A** Inclui bandeja/ tray included
B Inclui bandeja e estojo/ tray and box included
C Inclui 2 bandejas e estojo/ 2 tray and box included
D Inclui bandeja com o dobro da capacidade e estojo/ tray with double capacity and box included

MALAS DE FERRAMENTAS PLÁSTICO - ALUMÍNIO
PLASTIC-ALUMINIUM TOOLS BOXES



 **Material:** polipropileno preto
Asa em alumínio e fechos metálicos

 **Material:** black polypropylene
Aluminium handle and metallic locks

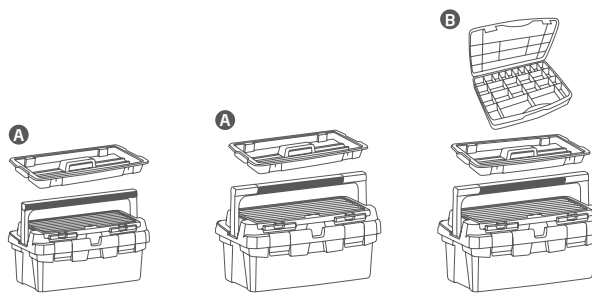

REF.	MODELO/ MODEL	MEDIDAS/ SIZES	
12162008	400	400 x 225 x 190 mm	6
12163005	450	450 x 285 x 250 mm	3
12164002	450-E	450 x 285 x 250 mm	3

- A** Inclui bandeja vermelha/ red tray included
B Inclui bandeja vermelha e estojo transparente/ red tray and transparent box included

MALAS DE FERRAMENTAS PLÁSTICO - ALUMÍNIO
PLASTIC-ALUMINIUM TOOLS BOXES



Material: polipropileno preto
Asa em alumínio e fechos metálicos

Material: black polypropylene
Aluminium handle and metallic locks

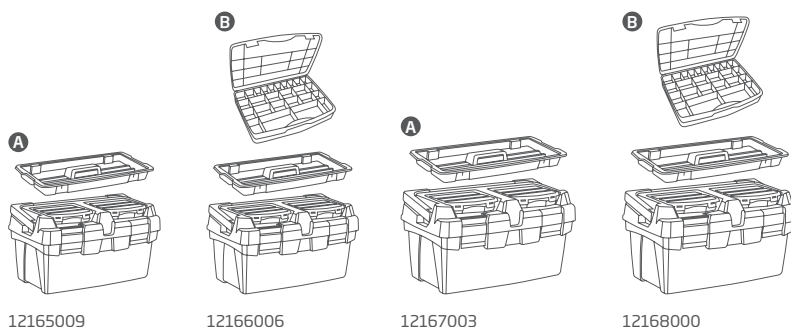

12165009 12166006 12167003 12168000

REF.	MODELO/ MODEL	MEDIDAS/ SIZES	
12165009	500	500 x 295 x 270 mm	3
12166006	500-E	500 x 295 x 270 mm	3
12167003	600	600 x 305 x 295 mm	3
12168000	600-E	600 x 305 x 295 mm	3

A Inclui bandeja vermelha/ red tray included

B Inclui bandeja vermelha e estojo transparente/ red tray and transparent box included

MALAS DE FERRAMENTAS PLÁSTICO - ALUMÍNIO
PLASTIC-ALUMINIUM TOOLS BOXES



Material: polipropileno preto
Asa em alumínio e fechos metálicos

Material: black polypropylene
Aluminium handle and metallic locks

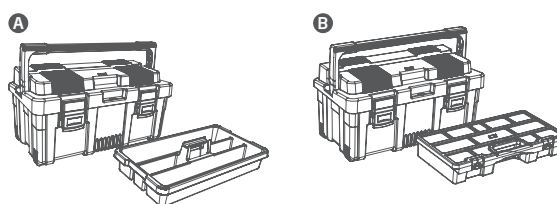

12170003 12171000

REF.	MODELO/ MODEL	MEDIDAS/ SIZES	
12170003	550-B	550 x 300 x 275 mm	3
12171000	550-E	550 x 300 x 275 mm	3

A Inclui bandeja vermelha/ red tray included

B Inclui estojo vermelho/transparente/ red/transparent box included

MALAS DE FERRAMENTAS PLÁSTICO - ALUMÍNIO
PLASTIC-ALUMINIUM TOOLS BOXES



Material: polipropileno preto
Asa em alumínio e fechos metálicos

Material: black polypropylene
Aluminium handle and metallic locks

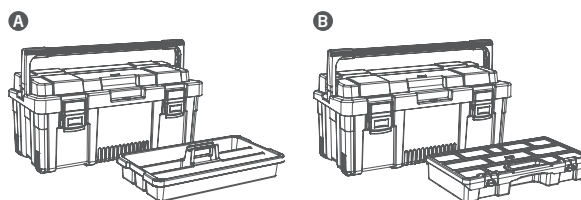

12172007 12173004

REF.	MODELO/ MODEL	MEDIDAS/ SIZES	
12172007	650-B	650 x 300 x 295 mm	2
12173004	650-E	650 x 300 x 295 mm	2

A Inclui bandeja vermelha/ red tray included

B Inclui estojo vermelho/transparente/ red/transparent box included

CARRO DE FERRAMENTAS MÓVEL MOBILE TOOL CHEST



Material: polipropileno
Cor: preto e vermelho
Ferramenta não incluída

Material: polypropylene
Color: black and red
Tools not included

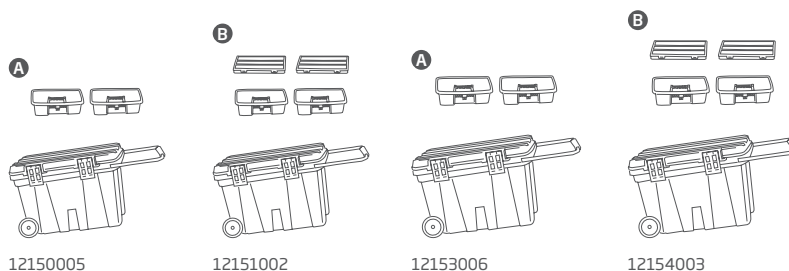

REF.	MODELO/ MODEL	MEDIDAS/ SIZES	
12150005	50	675 x 472 x 416 mm	1
12151002	51	675 x 472 x 416 mm	1
12153006	53	775 x 472 x 493 mm	1
12154003	54	775 x 472 x 493 mm	1

A Inclui 2 bandejas vermelhas e 5 suportes/ 2 red tray and 5 small bracket included

B Inclui 2 bandejas vermelhas e 2 estojos transparentes/ 2 red tray and 2 transparent boxes included



TROLLEY P/ FERRAMENTAS TRAIL BOX



Material: polipropileno
Cor: preto e vermelho
Ferramenta não incluída

Material: polypropylene
Color: black and red
Tools not included

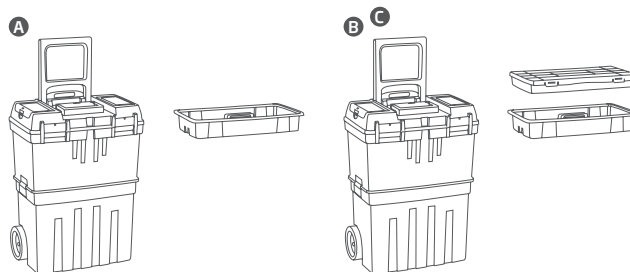

REF.	MODELO/ MODEL	MEDIDAS/ SIZES	
12157004	57	470 x 290 x 630 mm	1
12158001	58	470 x 290 x 630 mm	1

A Inclui bandeja vermelha/ red tray included

B Inclui bandeja vermelha e estojo transparente/ red tray and transparent box included

C Fechos metálicos/ metallics locks



**TROLLEY MULTIUSOS
TRAIL BOX**

REF.	MODELO/ MODEL	MEDIDAS/ SIZES	
12159008	59	500 x 410 x 770 mm	1



Material: polipropileno
Cor: preto e vermelho
Ferramenta não incluída

Material: polypropylene
Color: black and red
Tools not included

CONTÉM/ CONTAINS:



1 1 estojo/ box
REF. 12031007



2 1 estojo/ box
REF. 12033001



3 1 estojo/ box
REF. 12032400



4 1 mala/ case
REF. 12144998



5 1 mala caixote
mail box

**MALAS METÁLICAS P/ FERRAMENTAS
METALIC TOOL BOXES**



Material: cnapa de aço
Cor: vermelho
Pintura Epoxi
Ferramenta não incluída

Material: steel sheet
Color: red
Epoxi paint
Tools not included



12185007



12188008

REF.	MODELO/ MODEL	MEDIDAS/ SIZES	
12185007	403	404 x 200 x 240 mm	1
12188008	505	500 x 200 x 290 mm	1

A 3 compartimentos/ 3 contained

B 5 compartimentos/ 5 contained

CARROS PARA FERRAMENTAS TOOL TROLLEY



12194009 12190001 12193002 12191008

REF.	MODELO/ MODEL	MEDIDAS/ SIZES	
12194009	CT-0	820 x 365 x 900 mm	1
12190001	CT-1	935 x 385 x 985 mm	1
12193002	CT-2	735 x 370 x 835 mm	1
12191008	CT-5	750 x 460 x 850 mm	1

A gavetas/ drawers: 0 **B** gavetas/ drawers: 1 **C** gavetas/ drawers: 2 **D** gavetas/ drawers: 5

Material: chapa de aço
Cor: vermelho e preto
Pintura: Epoxi
Ferramenta: não incluída

Material: steel sheet
Color: red and black
Epoxi paint
Tools: not included

RODAS WHEELS



REF.	MODELO/ MODEL	MEDIDAS/ SIZES	
12195006	CT-0/CT-1	---	1
12196003	CT-2	---	1
12197000	CT-5	---	1

* 2 rodízios giratórios com travão + 2 rodízios fixos/ 2 mobile casters with brake + 2 fixed casters

SACO DE FERRAMENTAS TOOL BAGS



REF.	MODELO/ MODEL	MEDIDAS/ SIZES	
12080005	BN-1	345 x 220 x 225 mm	6

Material: poliéster 600D
Cor: preto e vermelho
Ferramenta: não incluída

Material: polyester 600D
Color: black and red
Tools: not included

SACO DE FERRAMENTAS TOOL BAGS



REF.	MODELO/ MODEL	MEDIDAS/ SIZES	
12082009	BN-3	455 x 250 x 265 mm	6

Material: poliéster 900D
Fundo: Polieteno
Cor: preto e vermelho
Ferramenta: não incluída

Material: polyester 900D
Base: polytene
Color: black and red
Tools: not included

BOLSA DE FERRAMENTAS
TOOL POCKET



REF.	MODELO/ MODEL	MEDIDAS/ SIZES	
12089602	---	---	10

Material: poliéster 600D
Cor: preto e vermelho

Material: polyester 600D
Color: black and red

BOLSA DE FERRAMENTAS
TOOL POCKET



REF.	MODELO/ MODEL	MEDIDAS/ SIZES	
12090608	---	---	6

Material: poliéster 600D
Cor: preto e vermelho

Material: polyester 600D
Color: black and red

BOLSA DE FERRAMENTAS
TOOL POCKET



REF.	MODELO/ MODEL	MEDIDAS/ SIZES	
12091605	---	---	10

Material: poliéster 900D
Cor: preto e vermelho

Material: polyester 900D
Color: black and red

BOLSA DE FERRAMENTAS
TOOL POCKET



REF.	MODELO/ MODEL	MEDIDAS/ SIZES	
12092602	---	---	6

Material: poliéster 900D
Cor: preto e vermelho

Material: polyester 900D
Color: black and red

MOCHILA DE FERRAMENTAS
BACKPACK TOOL BAG

NOVO
NEW



REF.	MODELO/ MODEL	MEDIDAS/ SIZES	
12097607	MN-1	490 x 390 x 190 mm	2



Material: poliéster 600D
Capacidade: 30 Ltrs.

Material: polyester 600D
Capacity: 30 Ltrs.

MOCHILA DE FERRAMENTAS C/ TROLLEY
TOOL TROLLEY BACKPACK

NOVO
NEW



REF.	MODELO/ MODEL	MEDIDAS/ SIZES	
12098604	MN-2	510 x 380 x 223 mm	2



Material: poliéster 900D e rodas em PU
Capacidade: 33 Ltrs.

Material: polyester 900D and wheels in PU
Capacity: 30 Ltrs.

**CAIXAS STOCK
STACKABLE DRAWERS**

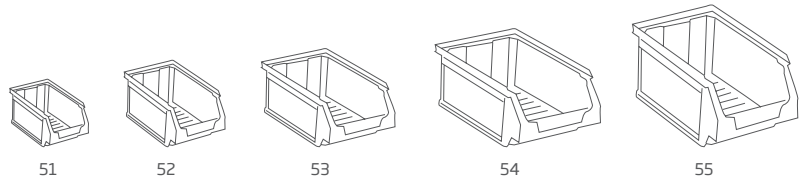
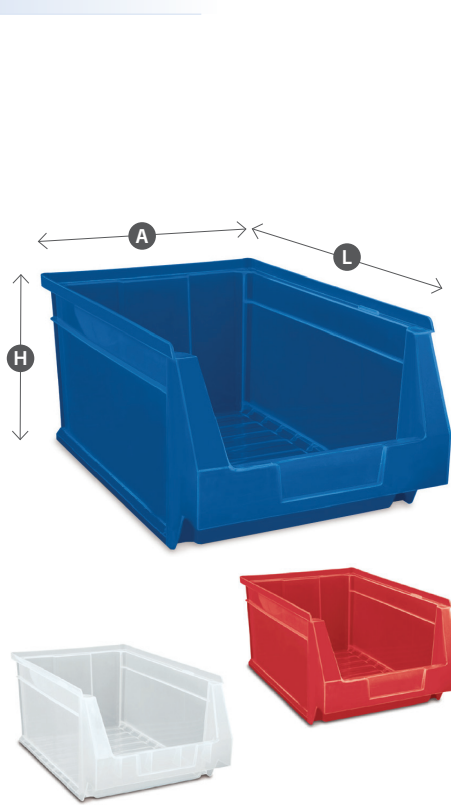

REF.	MODELO/ MODEL	L X A X H	
12251023	■ 51	170 x 100 x 80 mm	24
12251108	■ 51	170 x 100 x 80 mm	24
12251344	▣ 51	170 x 100 x 80 mm	24
12252020	■ 52	236 x 160 x 130 mm	15
12252105	■ 52	236 x 160 x 130 mm	15
12252341	▣ 52	236 x 160 x 130 mm	15
12253027	■ 53	336 x 160 x 130 mm	10
12253102	■ 53	336 x 160 x 130 mm	10
12253348	▣ 53	336 x 160 x 130 mm	10
12254024	■ 54	336 x 216 x 155 mm	12
12254109	■ 54	336 x 216 x 155 mm	12
12254345	▣ 54	336 x 216 x 155 mm	12
12255021	■ 55	336 x 216 x 200 mm	10
12255106	■ 55	336 x 216 x 200 mm	10
12255342	▣ 55	336 x 216 x 200 mm	10



Material: polipropileno
Cor: azul, vermelho e transparente

Material: polipropylene
Color: blue, red and transparent

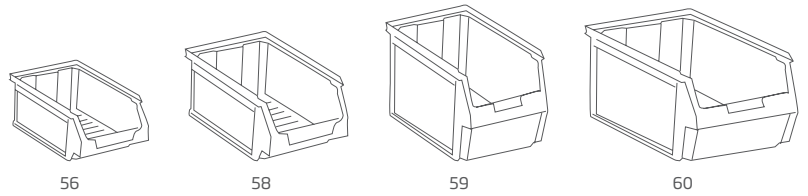

REF.	MODELO/ MODEL	L X A X H	
12256028	■ 56	420 x 270 x 175 mm	8
12256103	■ 56	420 x 270 x 175 mm	8
12256349	▣ 56	420 x 270 x 175 mm	8
12258022	■ 58	500 x 303 x 200 mm	12
12258107	■ 58	500 x 303 x 200 mm	12
12258343	▣ 58	500 x 303 x 200 mm	12
12259029	■ 59	500 x 303 x 300 mm	6
12259104	■ 59	500 x 303 x 300 mm	6
12259340	▣ 59	500 x 303 x 300 mm	6
12260025	■ 60	600 x 400 x 300 mm	6
12260100	■ 60	600 x 400 x 300 mm	6
12260346	▣ 60	600 x 400 x 300 mm	6

**CAIXAS STOCK
STACKABLE DRAWERS**



REF.	MODELO/ MODEL	L X A X H	
12268021	■ 5040	500 x 395 x 320 mm	7
12268069	■ 5040	500 x 395 x 320 mm	7
12268106	■ 5040	500 x 395 x 320 mm	7
12268342	▣ 5040	500 x 395 x 320 mm	7

Material: polipropileno
Cor: azul e cinza

Material: polipropylene
Color: blue and grey

CAIXAS STOCK DOBRÁVEIS
STACKABLE FOLDING DRAWERS

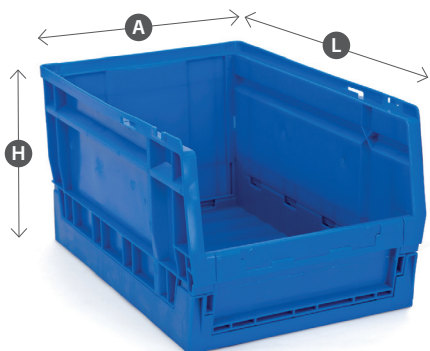

REF.	MODELO/ MODEL	L X A X H	
12204029	■ 54P	336 x 216 x 175 mm	11
12204340	▣ 54P	336 x 216 x 175 mm	11
12206023	■ 56P	420 x 270 x 200 mm	11
12206344	▣ 56P	420 x 270 x 200 mm	11
12209024	■ 59P	500 x 303 x 275 mm	8
12209345	▣ 59P	500 x 303 x 275 mm	8
12210020	■ 60P	600 x 400 x 325 mm	6
12210341	▣ 60P	600 x 400 x 325 mm	6

APTO PARA USO ALIMENTAR
Registo sanitário/Health registration
nº 3904321/V

Material: polipropileno
Cor: azul e transparente

Material: polypropylene
Color: blue and transparent



KIT COLGAR
HANGING KIT

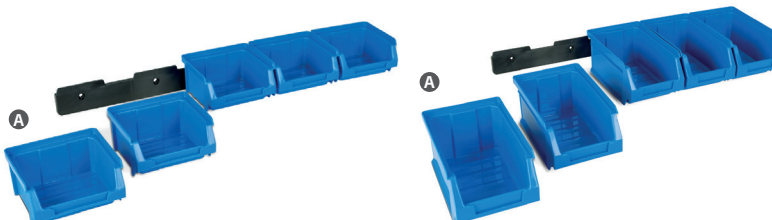

12250903

12251900

REF.	MODELO/ MODEL	L X A X H	
12250903	G-50	91 x 520 x 53 mm	10
12251900	G-51	170x520x80mm	10

Gaveta: polipropileno
Suporte: poliestireno
Incluído: 3/5 gavetas + suporte

Drawer: polypropylene
Hanger: polystyrene
Included: 3/5 drawers + 1 hanger

A 5 gavetas e 1 suporte / 5 drawers and 1 hanger

KIT CAIXAS STOCK DOBRÁVEIS
STACKABLE FOLDING DRAWER SET

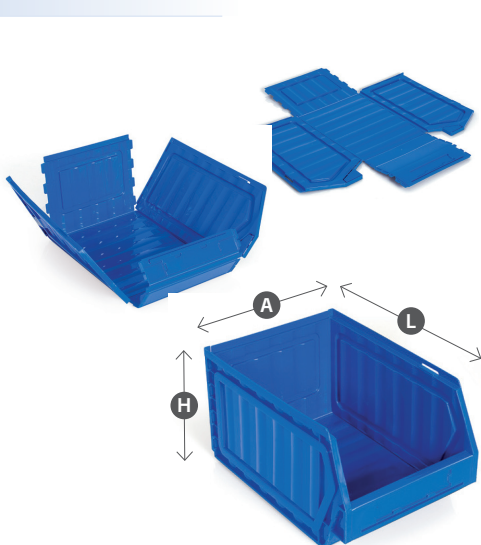

REF.	MODELO/ MODEL	L X A X H	
12202025	■ 52P	236x160x130mm	8
12202346	□ 52P	236x160x130mm	8
12203022	■ 53P	336x160x130mm	8
12203343	□ 53P	336x160x130mm	8

* Kit c/ 5 caixas/ set with 5 drawers



APTO PARA USO ALIMENTAR
Registo sanitário/Health registration
nº 3904321/V

Material: polipropileno
Conteúdo: 1 kit = 5 gavetas
Cor: azul e transparente

Material: polypropylene
Content: 1 kit = 5 drawers
Color: blue and transparent

EURO CAIXAS
EURO BOX

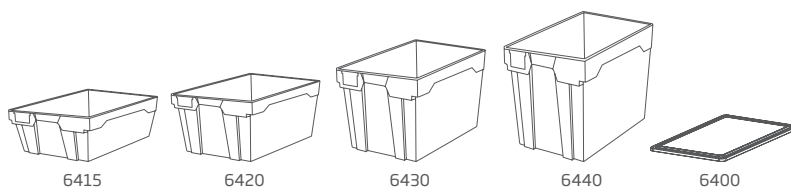
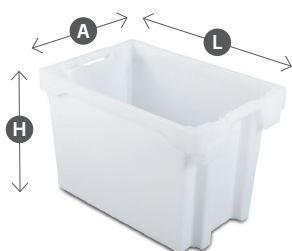

REF.	MODELO/ MODEL	L X A X H	
12261008	■ 6415	600x400x150mm	6
12261299	□ 6415	600x400x150mm	6
12262005	■ 6420	600x400x200mm	6
12262296	□ 6420	600x400x200mm	6
12263002	■ 6430	600x400x300mm	6
12263293	□ 6430	600x400x300mm	6
12264009	■ 6440	600x400x400mm	6
12264290	□ 6440	600x400x400mm	6
12299001	■ 6400	600 x 405 x 29 mm	6
12299292	□ 6400	600 x 405 x 29 mm	6

APTO PARA USO ALIMENTAR
Registo sanitário/Health registration
nº 3904321/V

Material: polipropileno
Cor: azul e branco

Material: polypropylene
Color: blue and white

EURO CAIXAS COM TAMPA EURO BOX WITH COVER

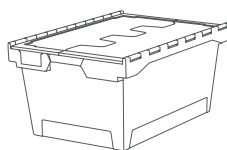
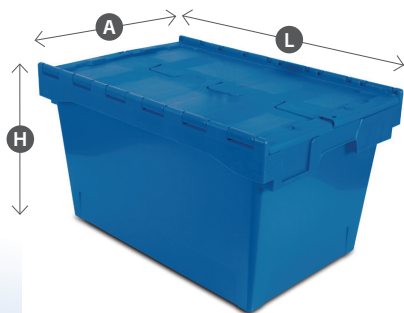

6424-T

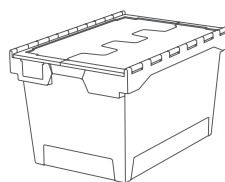

6434-T

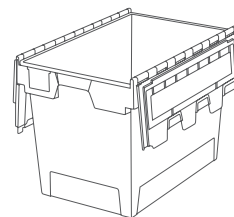

6444-T

REF.	MODELO/ MODEL	L X A X H	
12265006	6424-T	600x400x240 mm	6
12266003	6434-T	600x400x340 mm	6
12267000	6444-T	600x400x440 mm	6

Material: polipropileno
Cor: azul

Material: polypropylene
Color: blue

CAIXAS PARA ESTANTES DRAWERS FOR SHELVES

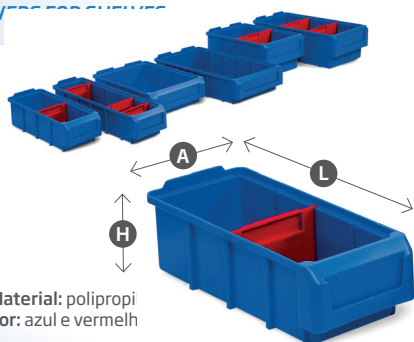

Material: polipropileno
Cor: azul e vermelho

Material: polypropylene
Color: blue and red

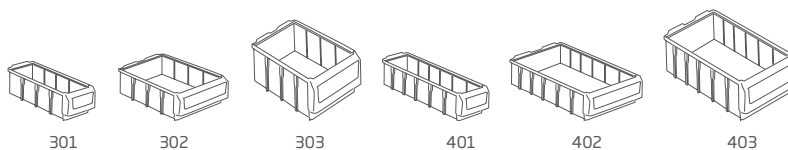

REF.	MODELO/ MODEL	L X A X H	
12355004	301	291 x 116 x 90 mm	20
12356001	302	291 x 232 x 90 mm	10
12357008	303	291 x 232 x 140 mm	8
12360008	401	391 x 116 x 90 mm	20
12361005	402	391 x 232 x 90 mm	10
12362002	403	291 x 232 x 140 mm	8

SEPARADORES PARA CAIXAS DIVIDERS FOR DRAWERS

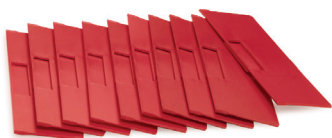

Material: polipropileno
Cor: vermelho

Material: polypropylene
Color: red

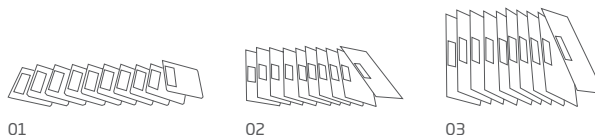

REF.	MODELO/ MODEL	MEDIDAS/ SIZES	
12390005	01	103 x 79 mm	20
12391002	02	219 x 79 mm	10
12392009	03	219 x 129 mm	10

ESTANTES METÁLICAS METAL SHELVES



REF.	MODELO/ MODEL	A X L X H		€
12398001	A 300	1030 x 337 x 2000 mm	1	436,55
12399008	A 400	1030 x 437 x 2000 mm	1	500,60

A 4 prumos, 16 prateleiras 300/400 e suportes/ 4 struts, 16 trays 300/400 and supports

KIT ESTANTE METÁLICA
METAL SHELVES KIT

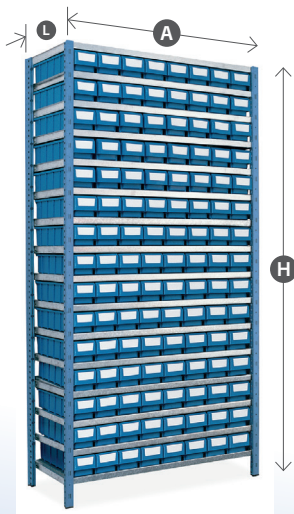

REF.	MODELO/ MODEL	A X L X H	
12398308	A 301	1030x337x2000 mm	1
12399305	B 401	1030x437x2000 mm	1

- A** 1 estante Ref. 12398001 (16 prateleiras), 120 caixas Ref. 12355004, 360 separadores Ref. 12390005
1 shelf Ref. 12398001 (16 trays), 120 drawers Ref. 12355004, 360 dividers Ref. 12390005
- B** 1 estante Ref. 12399008 (16 prateleiras), 120 caixas Ref. 12360008, 600 separadores Ref. 12390005
1 shelf Ref. 12399008 (16 trays), 120 drawers Ref. 12360008, 600 dividers Ref. 12390005

KIT ESTANTE METÁLICA
METAL SHELVES KIT

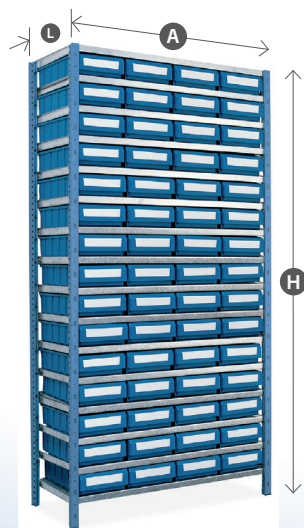

REF.	MODELO/ MODEL	A X L X H	
12398315	A 302	1030x337x2000 mm	1
12399312	B 402	1030x437x2000 mm	1

- A** 1 estante Ref. 12398001 (16 prateleiras), 60 caixas Ref. 12356001, 180 separadores Ref. 12391002
1 shelf Ref. 12398001 (16 trays), 60 drawers Ref. 12356001, 180 dividers Ref. 12391002
- B** 1 estante Ref. 12399008 (16 prateleiras), 60 caixas Ref. 12361005, 300 separadores Ref. 12391002
1 shelf Ref. 12399008 (16 trays), 60 drawers Ref. 12361005, 300 dividers Ref. 12391002

KIT ESTANTE METÁLICA
METAL SHELVES KIT

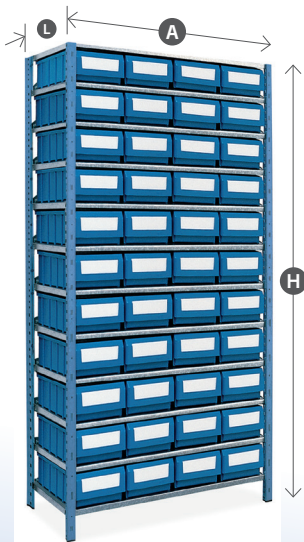

REF.	MODELO/ MODEL	A X L X H	
12398322	A 303	1030x337x2000 mm	1
12399329	B 403	1030x437x2000 mm	1

- A** 1 estante Ref. 12398001 (12 prateleiras), 48 caixas Ref. 12357008, 130 separadores Ref. 12392009
1 shelf Ref. 12398001 (12 trays), 48 drawers Ref. 12357008, 130 dividers Ref. 12392009
- B** 1 estante Ref. 12399008 (12 prateleiras), 48 caixas Ref. 12362002, 150 separadores Ref. 12392009
1 shelf Ref. 12399008 (12 trays), 48 drawers Ref. 12362002, 150 dividers Ref. 12392009

KIT ESTANTE METÁLICA METAL SHELVES KIT



REF.	MODELO/ MODEL	A X L X H	
12398339	A 310	1030 x 337 x 2000 mm	1
12399336	B 410	1030 x 437 x 2000 mm	1

- 1 estante Ref. 12398001 (15 prateleiras), 40 caixas Ref. 12355004, 20 caixas Ref. 12356001, 16 caixas Ref. 12357008, 120 separadores Ref. 12390005, 60 separadores Ref. 12391002, 40 separadores Ref. 12392009
- A** 1 shelf Ref. 12398001 (15 trays), 40 drawers Ref. 12355004, 20 drawers Ref. 12356001, 16 drawers Ref. 12357008, 120 dividers Ref. 12390005, 60 dividers Ref. 12391002, 40 dividers Ref. 12392009
- 1 estante Ref. 12399008 (15 prateleiras), 40 caixas Ref. 12360008, 20 caixas Ref. 12361005, 16 caixas Ref. 12362002, 200 separadores Ref. 12390005, 100 separadores Ref. 12391002, 80 separadores Ref. 12392009
- B** 1 shelf Ref. 12399008 (15 trays), 40 drawers Ref. 12360008, 20 drawers Ref. 12361005, 16 drawers Ref. 12362002, 200 dividers Ref. 12390005, 100 dividers Ref. 12391002, 80 dividers Ref. 12392009

CONTENTORES BASCULANTES CABINET WITH TILABLE DRAWERS

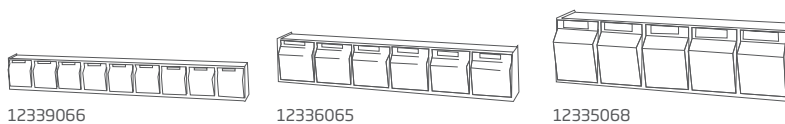

REF.	CAIXAS/ DRAWERS	MEDIDAS/ SIZES	
12339066	9	600 x 63 x 81 mm	12
12336065	6	600 x 92 x 114 mm	12
12335068	5	600x133x165mm	6

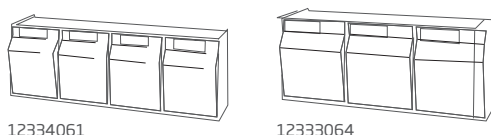

REF.	CAIXAS/ DRAWERS	MEDIDAS/ SIZES	
12334061	4	600x128x206mm	6
12333064	3	600x196x241mm	4

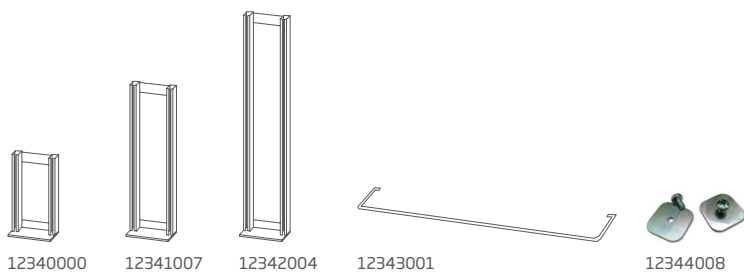

REF.	MODELO/ MODEL	MEDIDAS/ SIZES	
12340000	---	60 cm	1
12341007	---	121 cm	1
12342004	---	177 cm	1
12343001	---	---	1
12344008*	---	---	1

Material: poliestireno

Material: polystyrene

* kit c/ 2 parafusos + 2 anilhas/ set with 2 screws + 2 washers

KIT ESTANTE PLÁSTICO PLASTIC SHELVES KIT



Material: resina polipr
Acessórios não incluídos

Material: polypropylene resin
Accessories not included

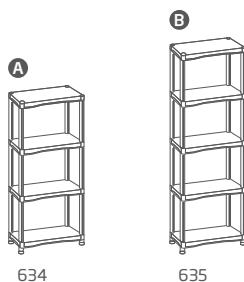

634

635

REF.	MODELO/ MODEL	MEDIDAS/ SIZES	
12228001	634	600x300x1370 mm	1
12227004	635	600x300x1800 mm	1

A 4 prateleiras, 12 prumos, 2 suportes/ 4 trays, 12 struts, 2 supports

B 5 prateleiras, 16 prumos, 2 suportes/ 5 trays, 16 struts, 2 supports

KIT ESTANTE PLÁSTICO PLASTIC SHELVES KIT



Material: resina polipropileno
Acessórios não incluídos

Material: polypropylene resin
Accessories not included

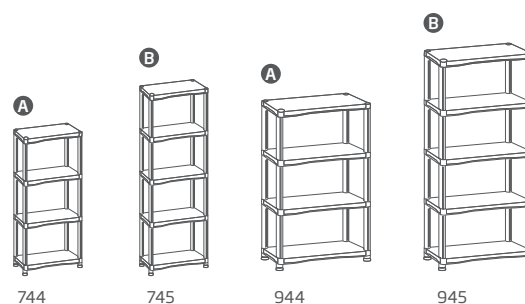

744

745

944

945

REF.	MODELO/ MODEL	MEDIDAS/ SIZES	
12226007	744	700x400x1366 mm	1
12225000	745	700x400x1800 mm	1
12221002	944	900x400x1366 mm	1
12220005	945	900x400x1800 mm	1

A 4 prateleiras, 12 prumos, 16 casquilhos reguladores, 2 suportes/ 4 trays, 12 struts, 16 caps, 2 supports

B 5 prateleiras, 16 prumos, 20 casquilhos reguladores, 3 suportes/ 5 trays, 16 struts, 20 caps, 3 supports

MÓDULOS METÁLICOS METAL STACKABLE MODULES

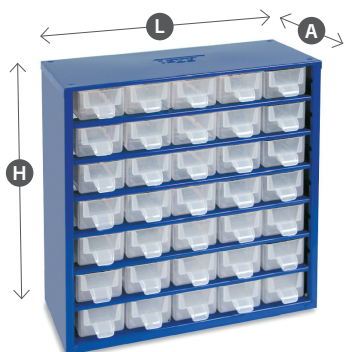

Armação em chapa de aço com pintura Epoxi
Gavetas em polipropileno

Steel sheet frame with epoxi paint
Polypropylene drawers



35/0/0

20/2/1

10/2/1

25/0/0

REF.	MODELO/ MODEL	L X A X H	
12316005	35/0/0	305x145x328 mm	4
12315008	20/2/1	305x145x328 mm	4
12317002	10/2/1	305x145x237 mm	4
12318009	25/0/0	305x145x237 mm	4

MÓDULO COM GAVETAS CABINET WITH DRAWERS



Armação: poliestireno
Gavetas: polipropileno

Frame: polystyrene
Drawers: polypropylene

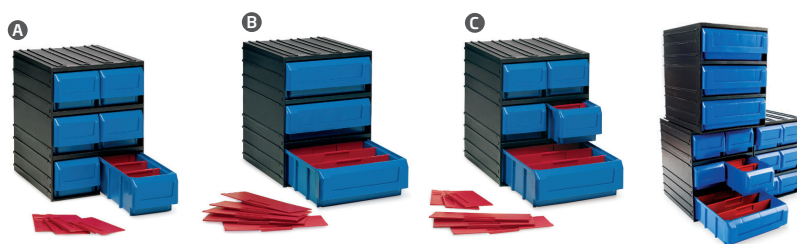

REF.	MODELO/ MODEL	L X A X H	
12350009	300/6	245x291x321 mm	2
12351006	300/3	245x291x321 mm	2
12352003	300/5	245x291x321 mm	2

A 6 caixas 291 x 116 x 95 mm e 18 separadores Ref. 12390005
6 drawers 291 x 116 x 95 mm and 18 dividers Ref. 12390005

B 3 caixas 291 x 232 x 95 mm e 9 separadores Ref. 12391002
3 drawers 291 x 232 x 95 mm and 9 dividers Ref. 12391002

C 4 caixas 291 x 116 x 95 mm + 1 caixa 291 x 232 x 95 mm e 12 separadores Ref. 12390005,
3 separadores Ref. 12391002
4 drawers 291 x 116 x 95 mm + 1 drawer 291 x 232 x 95 mm and 12 dividers Ref. 12390005,
3 dividers Ref. 12391002

MÓDULOS EMPILHÁVEIS STACKABLE CLASSIFIERS UNIT



Armação: poliestireno
Gavetas: polipropileno

Frame: polystyrene
Drawers: polypropylene



REF.	MODELO/ MODEL	L X A X H	
12304002	---	360x170x190 mm	4
12306006	---	360x170x190 mm	4
12309007	---	360x170x190 mm	4
12312007	---	360x170x190 mm	4

A 4 gavetas 160 x 170 x 80 mm / 4 drawers 160 x 170 x 80 mm

B 6 gavetas 100 x 170 x 80 mm / 6 drawers 100 x 170 x 80 mm

C 9 gavetas 100 x 170 x 50 mm / 9 drawers 100 x 170 x 50 mm

D 12 gavetas 80 x 170 x 50 mm / 12 drawers 80 x 170 x 50 mm

MÓDULOS EMPILHÁVEIS STACKABLE MODULES

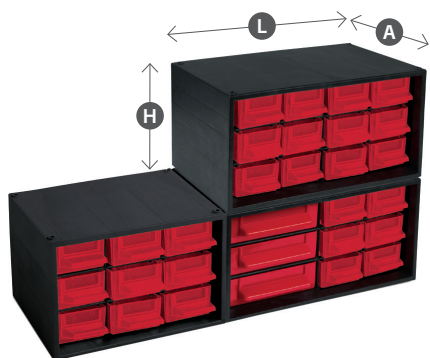

Material: poliestireno

Material: polystyrene



REF.	MODELO/ MODEL	L X A X H	
12346002	---	280x167x140 mm	6
12347009	---	280x167x140 mm	6
12348006	---	280x167x140 mm	6

A 6 gavetas 150 x 127 x 37 mm e 6 separadores
6 drawers 150 x 127 x 37 mm and 6 dividers

B 3 gavetas 150 x 127 x 37 mm + 6 gavetas 150 x 62 x 37 mm e 9 separadores
3 drawers 150 x 127 x 37 mm + 6 drawers 150 x 62 x 37 mm and 9 dividers

C 12 gavetas 150 x 62 x 37 mm e 12 separadores
12 drawers 150 x 62 x 37 mm and 12 dividers

MÓDULOS BANDEJAS TRAY MODULES

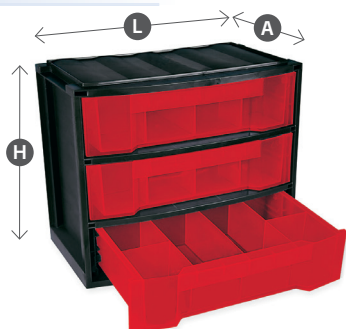

Armação: poliestireno
Gavetas: polipropileno

Frame: polystyrene
Drawers: polypropylene



12321009

12322006

12323003

REF.	MODELO/ MODEL	L X A X H	
12321009	---	290 x 167 x 255 mm	4
12322006	---	290 x 167 x 255 mm	4
12323003	---	290 x 167 x 255 mm	4

A 3 gavetas 256 x 162 x 65 mm/ 3 drawers 256 x 162 x 65 mm

B 1 gaveta 256 x 162 x 65 mm + 4 gavetas 256 x 162 x 30 mm
1 drawer 256 x 162 x 65 mm + 4 drawers 256 x 162 x 30 mm

C 6 gavetas 256 x 162 x 30 mm/ 6 drawers 256 x 162 x 30 mm

BIDÃO PARA JERRY CANS V

Pressão hidráulica
hydraulic pressure 200 KPa



Material: HDPE
Homologados p/ transportar produtos perigosos, classes 3, 6.1, 8 e 9

Material: HDPE
Approved for danger products,
class 3, 6.1, 8 and 9

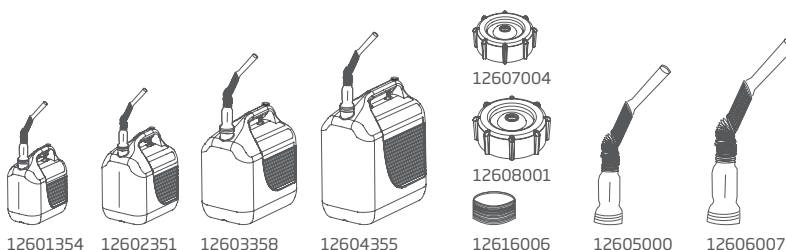

REF.	CAPAC./ CAPACITY	L X A X H	
12601354	5 L	230 x 145 x 257 mm	6
12602351	10 L	265 x 200 x 307 mm	6
12603358	20 L	345 x 234 x 377 mm	5
12604355	30 L	400 x 237 x 464 mm	5
12607004	5 L, 10 L	---	1
12608001	20 L, 30 L	---	1
12616006	5 L, 10 L, 20 L, 30 L	---	1
12605000	5 L, 10 L	---	1
12606007	20, 30 L	---	1



Normas: ADR, RID, IMDG, IATA/OACI/ Norms: ADR, RID, IMDG, IATA/OACI

BIDÃO PARA ÁGUA JERRY CANS WITH CAP/TAP



Material: HDPE

Material: HDPE

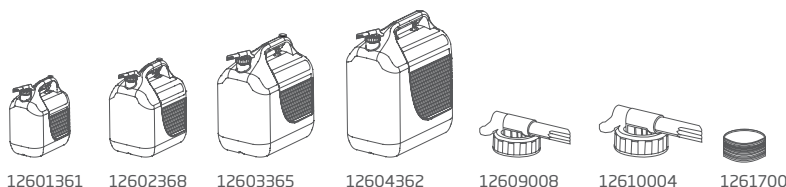

REF.	CAPAC./ CAPACITY	L X A X H	
12601361	5 L	230 x 145 x 257 mm	6
12602368	10 L	265 x 200 x 307 mm	6
12603365	20 L	345 x 234 x 377 mm	5
12604362	30 L	400 x 237 x 464 mm	5
12609008	5 L, 10 L	---	1
12610004	20 L, 30 L	---	1
12617003	5 L, 10 L, 20 L, 30 L	---	1



CONTENOR DE RESÍDUOS 50 L
WASTE CONTAINER 50 L



**NOVO
NEW** Disponível
Available
2017

REF.	MODELO/ MODEL	MEDIDAS/ SIZES	
12430022	■ 50P	399 x 428 x 509 mm	3
12430039	■ 50P	399 x 428 x 509 mm	3
12430008	■ 50P	399 x 428 x 509 mm	3
12430015	■ 50P	399 x 428 x 509 mm	3

Material: polipropileno
Com pedal

Material: polypropylene
With pedal

AZUL/ BLUE
Papél/ Paper

VERDE/ GREEN
Vidro/ Glass

CINZENTO/ GREY
Matéria biodegradável
Biodegradable matter

AMARELO/ YELLOW
Plástico e metal
Plastic and metal

CONTENOR DE RESÍDUOS 60 L
WASTE CONTAINER 60 L



**NOVO
NEW** Disponível
Available
2017

REF.	MODELO/ MODEL	MEDIDAS/ SIZES	
12431029	■ 60P	399 x 428 x 645 mm	3
12431036	■ 60P	399 x 428 x 645 mm	3
12431005	■ 60P	399 x 428 x 645 mm	3
12431012	■ 60P	399 x 428 x 645 mm	3

Material: polipropileno
Com pedal

Material: polypropylene
With pedal

AZUL/ BLUE
Papél/ Paper

VERDE/ GREEN
Vidro/ Glass

CINZENTO/ GREY
Matéria biodegradável
Biodegradable matter

AMARELO/ YELLOW
Plástico e metal
Plastic and metal

CONTENOR DE RESÍDUOS 80 L
WASTE CONTAINER 80 L



**NOVO
NEW** Disponível
Available
2017

REF.	MODELO/ MODEL	MEDIDAS/ SIZES	
12432026	■ 80	400 x 550 x 785 mm	3
12432033	■ 80	400 x 550 x 785 mm	3
12432002	■ 80	400 x 550 x 785 mm	3
12432019	■ 80	400 x 550 x 785 mm	3

Material: polipropileno

Material: polypropylene

AZUL/ BLUE
Papél/ Paper

VERDE/ GREEN
Vidro/ Glass

CINZENTO/ GREY
Matéria biodegradável
Biodegradable matter

AMARELO/ YELLOW
Plástico e metal
Plastic and metal

CONTENTOR DE RESÍDUOS 80 L
WASTE CONTAINER 80 L

**NOVO
NEW** Disponível
Available
2017



REF.	MODELO/ MODEL	MEDIDAS/ SIZES	
12433023	■ 80P	400x550x785 mm	3
12433030	■ 80P	400x550x785 mm	3
12433009	■ 80P	400x550x785 mm	3
12433016	■ 80P	400x550x785 mm	3

Material: polipropileno
Com pedal

Material: polypropylene
With pedal

AZUL/ BLUE
Papéis/Paper

VERDE/ GREEN
Vidro/Glass

CINZENTO/ GREY
Matéria biodegradável
Biodegradable matter

AMARELO/ YELLOW
Plástico e metal
Plastic and metal

CONTENTOR DE RESÍDUOS 100 L
WASTE CONTAINER 100 L



REF.	MODELO/ MODEL	MEDIDAS/ SIZES	
12420023	■ 100	600x568x770 mm	3
12420030	■ 100	600x568x770 mm	3
12420009	■ 100	600x568x770 mm	3
12420016	■ 100	600x568x770 mm	3
12420108	■ 100	600x568x770 mm	3
12440076	■ 100	600x568x770 mm	3

Material: polipropileno
Com rodas

Material: polypropylene
With wheels

AZUL/ BLUE
Papéis/Paper

VERDE/ GREEN
Vidro/Glass

CINZENTO/ GREY
Matéria biodegradável
Biodegradable matter

AMARELO/ YELLOW
Plástico e metal
Plastic and metal

VERMELHO/ RED
Resíduos perigosos
Hazardous waste

CONTENTOR DE RESÍDUOS C/ PEDAL 100 L
WASTE CONTAINER WITH PEDAL 100 L



REF.	MODELO/ MODEL	MEDIDAS/ SIZES	
12421020	■ 100P	600x568x770 mm	3
12421037	■ 100P	600x568x770 mm	3
12421006	■ 100P	600x568x770 mm	3
12421013	■ 100P	600x568x770 mm	3
12421105	■ 100P	600x568x770 mm	3
12441073	■ 100P	600x568x770 mm	3

Material: polipropileno
Com rodas e pedal

Material: polypropylene
With wheels and pedal

AZUL/ BLUE
Papéis/Paper

VERDE/ GREEN
Vidro/Glass

CINZENTO/ GREY
Matéria biodegradável
Biodegradable matter

AMARELO/ YELLOW
Plástico e metal
Plastic and metal

VERMELHO/ RED
Resíduos perigosos
Hazardous waste

CONTENTOR DE RESÍDUOS 120 L
WASTE CONTAINER 120 L



REF.	MODELO/ MODEL	MEDIDAS/ SIZES	📦
12422027	■ 120	600 x 568 x 886 mm	3
12422034	■ 120	600 x 568 x 886 mm	3
12422003	■ 120	600 x 568 x 886 mm	3
12422010	■ 120	600 x 568 x 886 mm	3
12422102	■ 120	600 x 568 x 886 mm	3
12442070	■ 120	600 x 568 x 886 mm	3

🇧🇷 **Material: polipropileno**
Com rodas

🇬🇧 **Material: polypropylene**
With wheels

♻️ **AZUL/ BLUE**
Papel/ Paper

♻️ **VERDE/ GREEN**
Vidro/ Glass

♻️ **CINZENTO/ GREY**
Matéria biodegradável
Biodegradable matter

♻️ **AMARELO/ YELLOW**
Plástico e metal
Plastic and metal

♻️ **VERMELHO/ RED**
Resíduos perigosos
Hazardous waste

CONTENTOR DE RESÍDUOS C/ PEDAL 120 L
WASTE CONTAINER WITH PEDAL 120 L



REF.	MODELO/ MODEL	MEDIDAS/ SIZES	📦
12423024	■ 120P	600 x 568 x 886 mm	3
12423031	■ 120P	600 x 568 x 886 mm	3
12423000	■ 120P	600 x 568 x 886 mm	3
12423017	■ 120P	600 x 568 x 886 mm	3
12423109	■ 120P	600 x 568 x 886 mm	3
12443077	■ 120P	600 x 568 x 886 mm	3

🇧🇷 **Material: polipropileno**
Com rodas e pedal

🇬🇧 **Material: polypropylene**
With wheels and pedal

♻️ **AZUL/ BLUE**
Papel/ Paper

♻️ **VERDE/ GREEN**
Vidro/ Glass

♻️ **CINZENTO/ GREY**
Matéria biodegradável
Biodegradable matter

♻️ **AMARELO/ YELLOW**
Plástico e metal
Plastic and metal

♻️ **VERMELHO/ RED**
Resíduos perigosos
Hazardous waste

CONTENTOR DE RESÍDUOS C/ PEDAL 120 L
WASTE CONTAINER WITH PEDAL 120 L



REF.	MODELO/ MODEL	MEDIDAS/ SIZES	📦
12443022	■ 120P	600 x 568 x 886 mm	3
12443015	■ 120P	600 x 568 x 886 mm	3
12443008	■ 120P	600 x 568 x 886 mm	3

🇧🇷 **Material: polipropileno**
Com rodas e pedal

🇬🇧 **Material: polypropylene**
With wheels and pedal

♻️ **AZUL/ BLUE**
Papel/ Paper

♻️ **AMARELO/ YELLOW**
Plástico e metal
Plastic and metal

♻️ **CINZENTO/ GREY**
Matéria biodegradável
Biodegradable matter

CONTENTOR P/ JARDIM 120 L
GARDEN CONTAINER 120 L



REF.	MODELO/ MODEL	MEDIDAS/ SIZES	
12424007	120 VE	600 x 568 x 886 mm	3

Material: polipropileno
Com rodas

Material: polypropylene
With wheels

Proteção UV
UV protection

CONTENTOR P/ JARDIM C/ PEDAL 120 L
GARDEN CONTAINER WITH PEDAL 120 L



REF.	MODELO/ MODEL	MEDIDAS/ SIZES	
12426001	120 VE-P	600 x 568 x 886 mm	3

Material: polipropileno
Com rodas e pedal

Material: polypropylene
With wheels and pedal

Proteção UV
UV protection

CONTENTOR DE RESÍDUOS 95 L
WASTE CONTAINER 95 L



REF.	MODELO/ MODEL	MEDIDAS/ SIZES	
12410024	■ 95	600 x 402 x 730 mm	4
12410031	■ 95	600 x 402 x 730 mm	4
12410000	■ 95	600 x 402 x 730 mm	4
12410017	■ 95	600 x 402 x 730 mm	4
12410109	■ 95	600 x 402 x 730 mm	4

Material: polipropileno
Com fechos

Material: polypropylene
With locks

AZUL/ BLUE
Papéis/Paper

VERDE/ GREEN
Vidro/Glass

CINZENTO/ GREY
Matéria biodegradável
Biodegradable matter

AMARELO/ YELLOW
Plástico e metal
Plastic and metal

VERMELHO/ RED
Resíduos perigosos
Hazardous waste

CONTENTOR DE RESÍDUOS 75 L
WASTE CONTAINER 75 L



REF.	MODELO/ MODEL	MEDIDAS/ SIZES	
12411021	■ 75	600 x 402 x 560 mm	4
12411038	■ 75	600 x 402 x 560 mm	4
12411007	■ 75	600 x 402 x 560 mm	4
12411014	■ 75	600 x 402 x 560 mm	4
12411106	■ 75	600 x 402 x 560 mm	4

Material: polipropileno
Com fechos

Material: polypropylene
With locks

AZUL/ BLUE
Papel/ Paper

VERDE/ GREEN
Vidro/ Glass

CINZENTO/ GREY
Matéria biodegradável
Biodegradable matter

AMARELO/ YELLOW
Plástico e metal
Plastic and metal

VERMELHO/ RED
Resíduos perigosos
Hazardous waste

CONTENTOR DE RESÍDUOS 50 L
WASTE CONTAINER 50 L



REF.	MODELO/ MODEL	MEDIDAS/ SIZES	
12412028	■ 50	410 x 400 x 510 mm	4
12412035	■ 50	410 x 400 x 510 mm	4
12412004	■ 50	410 x 400 x 510 mm	4
12412011	■ 50	410 x 400 x 510 mm	4
12412103	■ 50	410 x 400 x 510 mm	4

Material: polipropileno
Com fechos

Material: polypropylene
With locks

AZUL/ BLUE
Papel/ Paper

VERDE/ GREEN
Vidro/ Glass

CINZENTO/ GREY
Matéria biodegradável
Biodegradable matter

AMARELO/ YELLOW
Plástico e metal
Plastic and metal

VERMELHO/ RED
Resíduos perigosos
Hazardous waste

CONTENTOR MULTIUSOS 30 L
CONTAINER MULTIPURPOSE 30 L



REF.	MODELO/ MODEL	MEDIDAS/ SIZES	
12415029	■ 30	392 x 399 x 330 mm	5
12415036	■ 30	392 x 399 x 330 mm	5
12415005	■ 30	392 x 399 x 330 mm	5
12415012	■ 30	392 x 399 x 330 mm	5
12415104	■ 30	392 x 399 x 330 mm	5

Material: polipropileno

Material: polypropylene

AZUL/ BLUE
Papel/ Paper

VERDE/ GREEN
Vidro/ Glass

CINZENTO/ GREY
Matéria biodegradável
Biodegradable matter

AMARELO/ YELLOW
Plástico e metal
Plastic and metal

VERMELHO/ RED
Resíduos perigosos
Hazardous waste

TAMPA CONTENTOR DE RESÍDUOS 75 L - 95 L
CONTAINER COVER 75 L - 95 L



REF.	MODELO/ MODEL	MEDIDAS/ SIZES	
12413025	■ 95/75 L	518 x 402 x 74 mm	4
12413032	■ 95/75 L	518 x 402 x 74 mm	4
12413001	■ 95/75 L	518 x 402 x 74 mm	4
12413018	■ 95/75 L	518 x 402 x 74 mm	4
12413100	■ 95/75 L	518 x 402 x 74 mm	4

Material: polipropileno

Material: polypropylene

AZUL/ BLUE
Papéis/Paper

VERDE/ GREEN
Vidro/Glass

CINZENTO/ GREY
Matéria biodegradável
Biodegradable matter

AMARELO/ YELLOW
Plástico e metal
Plastic and metal

VERMELHO/ RED
Resíduos perigosos
Hazardous waste

TAMPA CONTENTOR DE RESÍDUOS 50 L
CONTAINER COVER 50 L



REF.	MODELO/ MODEL	MEDIDAS/ SIZES	
12414022	■ 50 L	399 x 399 x 54 mm	4
12414039	■ 50 L	399 x 399 x 54 mm	4
12414008	■ 50 L	399 x 399 x 54 mm	4
12414015	■ 50 L	399 x 399 x 54 mm	4
12414107	■ 50 L	399 x 399 x 54 mm	4

Material: polipropileno

Material: polypropylene

AZUL/ BLUE
Papéis/Paper

VERDE/ GREEN
Vidro/Glass

CINZENTO/ GREY
Matéria biodegradável
Biodegradable matter

AMARELO/ YELLOW
Plástico e metal
Plastic and metal

VERMELHO/ RED
Resíduos perigosos
Hazardous waste

TAMPA CONTENTOR DE RESÍDUOS 100 L - 120 L
CONTAINER COVER 100 L - 120 L



REF.	MODELO/ MODEL	MEDIDAS/ SIZES	
12425028	■ 100/120 L	572 x 522 x 92 mm	4
12425035	■ 100/120 L	572 x 522 x 92 mm	4
12425004	■ 100/120 L	572 x 522 x 92 mm	4
12425011	■ 100/120 L	572 x 522 x 92 mm	4
12425103	■ 100/120 L	572 x 522 x 92 mm	4

Material: polipropileno

Material: polypropylene

AZUL/ BLUE
Papéis/Paper

VERDE/ GREEN
Vidro/Glass

CINZENTO/ GREY
Matéria biodegradável
Biodegradable matter

AMARELO/ YELLOW
Plástico e metal
Plastic and metal

VERMELHO/ RED
Resíduos perigosos
Hazardous waste

EXTENSÕES ELÉTRICAS
EXTENSION CABLES



Ficha e tomada 2P + T/ Plug and socket 2P + T

REF.	POTÊNCIA/ POWER	CABO/ CABLE	
12570001	250 V ~ 16 A 3500 W	H05VV-F 3G1,5 - 2 mts	10
12571008	250 V ~ 16 A 3500 W	H05VV-F 3G1,5 - 3 mts	10
12572005	250 V ~ 16 A 3500 W	H05VV-F 3G1,5 - 4 mts	10

CE

Proteção para crianças
Kids protection

EXTENSÕES ELÉCTRICAS EXTENSION CABLES



CE

Ficha e tomada 2P + T/ Plug and socket 2P + T

REF.	POTÊNCIA/ POWER	CABO/ CABLE	
12575006	250 V ~ 16 A 3500 W	H05VV-F 3G1,5 - 10 mts	6
12576003	250 V ~ 16 A 3500 W	H05VV-F 3G1,5 - 15 mts	6
12577000	250 V ~ 16 A 3500 W	H05VV-F 3G1,5 - 25 mts	6



Proteção para crianças
Kids protection



BASES MÚLTIPLAS MULTIPLE SOCKETS



CE

4 bases 2P + T, tampa e interruptor, cabo de borracha - Neoprene
4 bases 2P + T, cover and switch, rubber - Neoprene cable

REF.	POTÊNCIA/ POWER	CABO/ CABLE	
12834004	16 A 250 V ~ 3500 W	H07RN-F 3G1.5 - 2 mts	6



BASES MÚLTIPLAS MULTIPLE SOCKETS



CE

6 bases 2P + T, tampa e interruptor, cabo de borracha - Neoprene
6 bases 2P + T, cover and switch, rubber - Neoprene cable

REF.	POTÊNCIA/ POWER	CABO/ CABLE	
12836008	16 A 250 V ~ 3500 W	H07RN-F 3G1.5 - 2 mts	6



BASES MÚLTIPLAS MULTIPLE SOCKETS



CE

Proteção para crianças
Kids protection

12800603
3 bases 2P + T
3 sockets 2P + T



12801600
3 bases 2P + T com interruptor
3 sockets 2P + T with switch



REF.	POTÊNCIA/ POWER	CABO/ CABLE	
12800603	10/16A 250V ~ 3680 W	H05VV-F 3G1,5 - 1,4 mts	10
12801600	10/16A 250V ~ 3680 W	H05VV-F 3G1,5 - 1,4 mts	10

12805608
4 bases 2P + T
4 sockets 2P + T



12806605
4 bases 2P + T com interruptor
4 sockets 2P + T with switch



REF.	POTÊNCIA/ POWER	CABO/ CABLE	
12805608	10/16A 250V ~ 3680 W	H05VV-F 3G1,5 - 1,4 mts	10
12806605	10/16A 250V ~ 3680 W	H05VV-F 3G1,5 - 1,4 mts	10

12807602
5 bases 2P + T
5 sockets 2P + T



12808609
5 bases 2P + T com interruptor
5 sockets 2P + T with switch



REF.	POTÊNCIA/ POWER	CABO/ CABLE	
12807602	10/16A 250V ~ 3680 W	H05VV-F 3G1,5 - 1,4 mts	10
12808609	10/16A 250V ~ 3680 W	H05VV-F 3G1,5 - 1,4 mts	10

12810602
6 bases 2P + T
6 sockets 2P + T



12811609
6 bases 2P + T com interruptor
6 sockets 2P + T with switch



REF.	POTÊNCIA/ POWER	CABO/ CABLE	
12810602	10/16A 250V ~ 3680 W	H05VV-F 3G1,5 - 1,4 mts	10
12811609	10/16A 250V ~ 3680 W	H05VV-F 3G1,5 - 1,4 mts	10

BASES MÚLTIPLAS
MULTIPLE SOCKETS



4 bases 2P + T com interruptor e proteção de voltagem
4 bases 2P + T with switch and voltage protection

REF.	POTÊNCIA/ POWER	CABO/ CABLE	
12814600	16 A 250 V ~ 3500 W	H05VV-F 3G1.5 - 1,5 mts	6



Proteção para crianças
Kids protection



BASES MÚLTIPLAS
MULTIPLE SOCKETS



6 bases 2P + T com interruptor e proteção de voltagem
6 bases 2P + T with switch and voltage protection

REF.	POTÊNCIA/ POWER	CABO/ CABLE	
12816604	16 A 250 V ~ 3500 W	H05VV-F 3G1.5 - 1,5 mts	6



Proteção para crianças
Kids protection



BASES MÚLTIPLAS
MULTIPLE SOCKETS



8 bases 2P + T com interruptor e proteção de voltagem
8 bases 2P + T with switch and voltage protection

REF.	POTÊNCIA/ POWER	CABO/ CABLE	
12818608	16 A 250 V ~ 3500 W	H05VV-F 3G1.5 - 1,5 mts	6



Proteção para crianças
Kids protection



LANTERNA PORTÁTIL 1.5W LED COB
PEN LIGHT 1.5W LED COB



REF.	POTÊNCIA MAX./ MAX POWER	
12500602	145 Lm	24

LANTERNA PORTÁTIL 1.5W COB + 1W LED
PEN LIGHT 1.5W COB + 1W LED



REF.	POTÊNCIA MAX./ MAX POWER	
12501609	145 Lm/ 60 Lm Recarregável/ Rechargeable	8

LANTERNA PORTÁTIL 3W COB + 6 LED
HAND LAMP 3W COB + 6 LED

NOVO
NEW



REF.	POTÊNCIA MAX./ MAX POWER	
12502606	280 Lm/ 30 Lm Recarregável/ Rechargeable	6

LANTERNA PORTÁTIL 3W SMD LED
HAND LAMP 3W SMD LED

NOVO
NEW



REF.	POTÊNCIA MAX./ MAX POWER	
12503603	300 Lm Carregador de mesa/ Desktop charger	6

EXTENSÃO ELÉCTRICA
CABLE REEL



2 bases 2P + T com térmotato/ 2 sockets 2P + T with thermostat

REF.	POTÊNCIA/ POWER	CABO/ CABLE	
12714009	250 V~ 10 A 2500 W	H05VV-F 3G1.0 - 5 mts	6

CE

Bricolage

Home-Diy

EXTENSÃO ELÉCTRICA
CABLE REEL



4 bases 2P + T com térmotato/ 4 sockets 2P + T with thermostat

REF.	POTÊNCIA/ POWER	CABO/ CABLE	
12729218	250 V~ 10 A 2500 W	H05VV-F 3G1.0 - 10 mts	6

CE

Bricolage

Home-Diy

EXTENSÃO ELÉCTRICA
CABLE REEL



CE

4 bases 2P + T com térmotato/ 4 sockets 2P + T with thermostat

REF.	POTÊNCIA/ POWER	CABO/ CABLE	
12734007	250 V~ 10 A 2500 W	H05VV-F 3G1,0 - 15 mts	6

Bricolage

Home-Diy

EXTENSÃO ELÉCTRICA
CABLE REEL



CE

REF.	POTÊNCIA/ POWER	CABO/ CABLE	
12749001	250 V~ 16 A 3500 W	H05VV-F 3G1,5 - 15 mts	2
12752001	250 V~ 10 A 2500 W	H05VV-F 3G1,0 - 25 mts	2

4 bases 2P + T com térmotato/ 4 sockets 2P + T with thermostat

OPÇÃO DE PALETE
BOX - PALET OPTION

Medidas/sizes:
1100 x 680 x 1164 mm
(80 unid./ unit.)

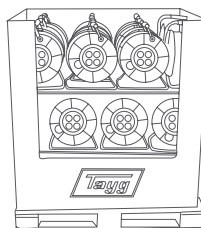

Indústria

Industry

EXTENSÃO ELÉCTRICA
CABLE REEL

IP-20
3.500 W



CE

REF.	POTÊNCIA/ POWER	CABO/ CABLE	
12771002	250 V~ 16 A 3500 W	H05VV-F 3G1,5 - 25 mts	2
12778001	250 V~ 16 A 3500 W	H05VV-F 3G1,5 - 50 mts	1

4 bases 2P + T com térmotato/ 4 sockets 2P + T with thermostat

OPÇÃO DE PALETE
BOX - PALET OPTION

Medidas/sizes:
1100 x 740 x 930 mm
Ref. 12771002 (60 unid./ unit.)
1020 x 805 x 1000 mm
Ref. 12778001 (48 unid./ unit.)

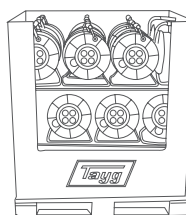

Suporte metálico, carro de plástico

Metal frame, plastic spool

**EXTENSÃO ELÉTRICA
CABLE REEL**

IP-20
3.500 W



REF.	POTÊNCIA/ POWER	CABO/ CABLE	
12770500	250 V~ 16 A 3500 W	H05VV-F 3G1,5 - 25 mts	1
12775505	250 V~ 16 A 3500 W	H05VV-F 3G1,5 - 50 mts	1

4 bases 2P + T com termostato/ 4 sockets 2P + T with thermostat

**OPÇÃO DE PALETE
BOX - PALET OPTION**

Medidas/ sizes:

1020 x 805 x 1000 mm
Ref. 12770500 (48 unid./ unit.)

1020 x 805 x 1000 mm
Ref. 12775505 (48 unid./ unit.)

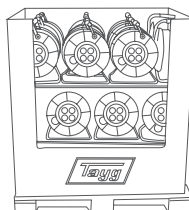

Suporte e carreto metálico

Metal frame and spool

**EXTENSÃO ELÉTRICA
CABLE REEL**

IP-20
3.000 W



REF.	POTÊNCIA/ POWER	CABO/ CABLE	
12770609	230 V~ 13 A 3000 W	H05VV-F 3G1,5 - 25 mts	1
12777608	230 V~ 13 A 3000 W	H05VV-F 3G1,5 - 50 mts	1

4 bases 2P + T com termostato/ 4 sockets 2P + T with thermostat

Suporte metálico, carreto de plástico

Metal frame, plastic spool

**EXTENSÃO ELÉTRICA
CABLE REEL**

IP-44
3.000 W



REF.	POTÊNCIA/ POWER	CABO/ CABLE	
12765605	230 V~ 13 A 3000 W	H05VV-F 3G1,5 - 25 mts	1
12766602	230 V~ 13 A 3000 W	H05VV-F 3G1,5 - 50 mts	1

4 bases 2P + T com termostato e tampa / 4 sockets 2P + T with thermostat and cover

Suporte metálico, carreto de plástico

Metal frame, plastic spool

EXTENSÃO ELÉCTRICA
CABLE REEL

IP-20
3.200 W



REF.	POTÊNCIA/ POWER	CABO/ CABLE	
12773600	230 V~ 3200 W	H05VV-F 3G1,5 - 25 mts	1

Base aérea
Suporte metálico, carreto de plástico

Aerial socket
Metal frame, plastic spool

EXTENSÃO ELÉCTRICA
CABLE REEL

IP-55
3.500 W



REF.	POTÊNCIA/ POWER	CABO/ CABLE	
12765001	250 V~ 16 A 3500 W	H05VV-F 3G1,5 - 25 mts	1
12766008	250 V~ 16 A 3500 W	H05VV-F 3G1,5 - 50 mts	1

3 bases 2P + T com térmstato e tampa / 3 sockets 2P + T with thermostat and cover

OPÇÃO DE PALETE
BOX - PALET OPTION

Medidas/sizes:
1122 x 805 x 1160 mm
(42 unid./ unit.)

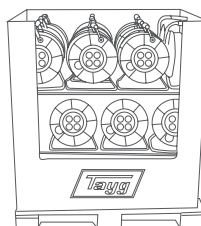

Suporte metálico, carreto de plástico

Metal frame, plastic spool

EXTENSÃO ELÉCTRICA
CABLE REEL

IP-55
4.000 W



REF.	POTÊNCIA/ POWER	CABO/ CABLE	
12785511	250 V~ 16 A 4000 W	H05VV-F 3G2,5 - 25 mts	1
12786518	250 V~ 16 A 4000 W	H05VV-F 3G2,5 - 50 mts	1

3 bases 2P + T com térmstato e tampa / 3 sockets 2P + T with thermostat and cover

OPÇÃO DE PALETE
BOX - PALET OPTION

Medidas/sizes:
1020 x 805 x 1000 mm
Ref. 12785511 (48 unid./ unit.)
1122x 805 x 1160 mm
Ref. 12785618 (42 unid./ unit.)

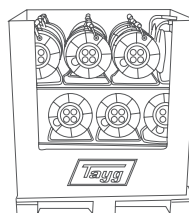

Suporte e carreto metálico

Metal frame and spool

EXTENSÃO ELÉTRICA
CABLE REEL

IP-55
3.500 W



CE

REF.	POTÊNCIA/ POWER	CABO/ CABLE	
12765506	250 V~ 16 A 3500 W	H07RN-F 3G1,5 - 25 mts	1
12766503	250 V~ 16 A 3500 W	H07RN-F 3G1,5 - 50 mts	1

3 bases 2P + T com termostato e tampa, cabo neoprene
3 sockets 2P + T with thermostat and cover, neoprene cable

Para instaladores eléctricos: Cumpre com a norma técnica complementar nº33
For electrical instalers: Comply with complementary technical instruction no 33

Suporte e carreto metálico

Metal frame and spool

EXTENSÃO ELÉTRICA
CABLE REEL

IP-67
3.500 W



CE

REF.	POTÊNCIA/ POWER	CABO/ CABLE	
12767500	250 V~ 16 A 3500 W	H07RN-F 3G1,5 - 25 mts	1
12768507	250 V~ 16 A 3500 W	H07RN-F 3G1,5 - 50 mts	1

2 bases 2P + T com termostato e tampa, cabo neoprene
2 sockets 2P + T with thermostat and cover, neoprene cable

Para instaladores eléctricos: Cumpre com a norma técnica complementar nº33
For electrical instalers: Comply with complementary technical instruction no 33

Suporte e carreto metálico

Metal frame and spool

EXTENSÃO ELÉTRICA
CABLE REEL

IP-44
7.000 W

380 V



CE

REF.	POTÊNCIA/ POWER	CABO/ CABLE	
12760518	380 V~ 16 A 7000 W	H05VV-F 4G1,5 - 25 mts	1
12780516	380 V~ 16 A 7000 W	H05VV-F 4G1,5 - 40 mts	1

2 bases 3P + T6h 380 V com termostato e tampa
2 sockets 3P + T6h 380 V with thermostat and cover

Suporte e carreto metálico

Metal frame and spool