



# MEBRA®

1992 - 2016

## Preçário

Tarifa | Price List | Liste de Prix

Ed. 9 | 02/2016







1	Índice - Português
3	Índice - Español
5	Index - English
7	Indice - Français
8	Apresentação da Empresa

## 1 - Sanitários - 10



11	1.0 - Torneiras e Componentes
66	1.1 - Saunas de Infravermelhos, Resguardos, Colunas e Rampas de Chuveiro, Chuveiros de Mão, Chuveiros Fixos e Acessórios
80	1.2 - Acessórios WC
96	1.3 - Sifões, Válvulas e Tubos Flexíveis
104	1.4 - Sifões e Tubos Flexíveis Cromados
107	1.5 - Acoplamentos para Sanitas
109	1.6 - Base de Ducha de Obra - Linnun
112	1.7 - Trituradores Sanitários e Estação de Bombagem
116	1.8 - Autoclismos, Tampos Sanita, Válvulas e Sifões
126	1.9 - Ligações Malha de Aço e Sanitárias, Acessórios Cromados

## 2 - Gestão de Água - 135



136	2.0 - Válvulas e Torneiras MEW®
147	2.1 - Válvulas e Torneiras Bugatti®
151	2.2 - Válvulas de Esfera PVC
153	2.3 - Acessórios Aperto Rápido PP p/ Tubo PE
156	2.4 - Abraçadeiras em PP p/ Tubo PE
163	2.5 - Acessórios Aperto Rápido Latão p/ Tubo PE
166	2.6 - Acessórios de Latão p/ Canalização
176	2.7 - Tubo e Acessórios Multicamada
183	2.8 - Sistemas de Tubagem e Acessórios PP-R e PP-RCT - Wefatherm
199	2.9 - Tubo Inox e Acessórios Bicone
203	2.10 - Caleira e Acessórios
208	2.11 - Caixas Sumidouros
210	2.12 - Contadores de Água e Acessórios
213	2.13 - Fixação, Vedação, Isolamento

## 3 - Gás - 219



## 5 - Aquecimento - 241



## 7 - Material Contra Incêndio - 285



## 4 - Tratamento de Água - 235



## 6 - Rega e Jardim - 271



## 8 - Outras Marcas e Informações Adicionais - 289









1	Índice - Português
3	Índice - Español
5	Index - English
7	Indice - Français
8	Presentación de la Empresa

## 1 - Sanitarios - 10



11	1.0 - Grifería y Componentes
66	1.1 - Saunas de Infrarrojo, Mamparas, Columnas y Kits de Ducha, Duchas de Mano, Duchas Fijas y Accesorios
80	1.2 - Acessórios WC
96	1.3 - Sifones, Válvulas y Tubos Flexibles
103	1.4 - Sifones y Tubos Flexibles Cromados
107	1.5 - manguitos Inodoro
109	1.6 - Base de Ducha de Obra - Linnum
112	1.7 - Trituradores Sanitarios y Estación de Bombeo
116	1.8 - Cisternas, Tapas WC, Válvulas y Sifones
126	1.9 - Conexiones Inox y Sanitarias, Accesorios Cromados

## 2 - Gestión de Agua - 135



136	2.0 - Válvulas y Grifos MEW®
147	2.1 - Válvulas y Grifos Bugatti®
151	2.2 - Válvulas de Esfera PVC
153	2.3 - Accesorios Compresión p/ Tubo PE
155	2.4 - Abrazaderas en PP p/ Tubo PE
163	2.5 - Accesorios Compresión Latón p/ Tubo PE
166	2.6 - Accesorios Latón p/ Canalización
176	2.7 - Tubería y Accesorios Multicapa
183	2.8 - Sistemas de Tubos y Accesorios PP-R y PP-RCT - Wefatherm®
199	2.9 - Tubos Inox y Accesorios de Compresión
203	2.10 - Canalón y Accesorios
208	2.11 - Calderetas y Sumideros
210	2.12 - Contadores de Agua y Accesorios
213	2.13 - Fijación, Sellado, Aislamiento

## 3 - Gas - 219



## 4 - Tratamiento de Agua - 235



## 5 - Calefacción - 241



## 6 - Riego y Jardín - 271



## 7 - Material Contra Incendio - 285



## 8 - Otras Marcas y Información - 289







1	Índice - Português
3	Índice - Español
5	Index - English
7	Indice - Français
8	Company presentation

## 1 - Sanitaryware - 10



11	1.0 - Taps and Accessories
66	1.1 - Infrared Saunas, Shower Enclosures, Shower Pannels and Kits, Hand Showers, Overhead Showers and Accessories
80	1.2 - WC Accessories
96	1.3 - Siphons, Valves and Flexible Pipes
104	1.4 - Siphons and Chrome Flexible Pipes
107	1.5 - WC Pan Connectors
109	1.6 - Tiled Shower Tray Waste Outlets
112	1.7 - Sanitary Macerators and Lifting Station
116	1.9 - Cisterns, Toilet Seat, Valves and Siphons
126	1.10 - S. S. Flexible Hoses and Sanitary Conections, Chrome Fittings

## 2 - Water Management - 135



136	2.0 - Valves and Bibcocks MEW®
147	2.1 - Valves and Bibcocks Bugatti®
151	2.2 - PVC Ball Valves
153	2.3 - Compression PP Fittings f/ PE Pipe
156	2.4 - PP Clamps f/ PE Pipe
163	2.5 - Compression Brass Fittings f/ PE Pipe
166	2.6 - Brass Fittings f/ Plumbing
176	2.7 - Pipe and Multilayer Accessories
183	2.8 - PP-R and PP-RCT Piping Systems and Accessories
199	2.9 - S. S. Pipe and Compression Fittings
203	2.10 - Gutter and Accessories
208	2.11 - Floor Drains and Gullies
210	2.12 - Water Meters and Accessories
212	2.13 - Fixing, Sealing, Insulation

## 3 - Gas - 219



## 4 - Water Treatment - 235



## 5 - Heating - 241



## 6 - Irrigation and Garden - 271



## 7 - Fire Equipment - 285



## 8 - Other Brands and Adictional Info - 289







1	Índice - Português
3	Índice - Español
5	Index - English
7	Indice - Français
8	Company presentation

## 1 - Produits Sanitaires - 10



11	1.0 - Robinets et Accessoires
66	1.1 - Saunas Infrarouge, Paroi de Douche, Colonne et Kits de Douche, Douchettes, Douches de Plafond et Accessoires
80	1.2 - Accessoires WC
96	1.3 - Siphons, Vannes et Tuyaux Flexibles
104	1.4 - Siphons et Tuyaux Flexibles Chromés
107	1.5 - Pipes WS
109	1.6 - Vidages p/ Plateau de Douche Carrelés
112	1.7 - Broyeurs et Sataion de Relevage
116	1.9 - Chasse d'Eau, Siège de Toilette, Vannes et Siphons
126	1.10 - Tuyaux Flexibles Inox et Raccords Sanitaires, Chrome Raccords

## 2 - Water Management - 135



136	2.0 - Vannes et Robinets MEW®
147	2.1 - Vannes et Robinets Bugatti®
151	2.2 - Vannes en PVC
153	2.3 - Compression Raccords PP p/ Tuyau PE
156	2.4 - Collier PP p/ Tuyau PE
163	2.5 - Raccords en Laiton à Compression p/ Tuyau PE
166	2.6 - Raccords en Laiton p/ Plomberie
176	2.7 - Tuyau Multicouche et Accessoires
183	2.8 - Systèmes et Accessoires de Tuyauterie PP-R et PP-RCT - Wefatherm®
199	2.9 - Tuyau Inox et Raccords à Compression
203	2.10 - Gouttière et Accessoires
208	2.11 - Avaloirs et Siphons de Sol
210	2.12 - Compteur d'eau et accessoires
213	2.13 - Fixation, Cachetage, Isolement

## 3 - Gaz - 219



## 4 - Traitement de l'Eau - 235



## 5 - Chauffage - 241



## 6 - Arrosage et Jardin - 271



## 7 - Équipements d'Incendie - 285



## 8 - Autres Marques et Informations Supplémentaires - 289



A MEBRA é uma empresa, de capital nacional, focalizada na distribuição de soluções nas áreas de sanitários, sistemas de gestão de água, sistemas de rega, climatização, gás e energias renováveis.

Dispõe de uma equipa comercial distribuída por todas as zonas geográficas do país (Continente, Açores e Madeira). A nível internacional está presente em diversos países, nomeadamente Angola, Moçambique, Cabo Verde, S. Tomé e Príncipe, Marrocos e Senegal.

Atualmente sediada em Vila de Prado, a MEBRA dispõe de instalações com uma área bruta de 20.000 m<sup>2</sup>, representando a área de implantação metade deste valor.

Desde a sua fundação, que uma das maiores apostas da MEBRA é na constante inovação tecnológica. A gestão de todos os processos é orientada, tendo em vista o mais elevado nível de satisfação por parte dos seus Clientes.

MEBRA es una empresa, de capital nacional, enfocada a la distribución de soluciones en las áreas de sistemas de gestión de agua, sistemas de riego, climatización, gas y energías renovables. Ofrece un equipo de ventas distribuido por todas las zonas geográficas del país (península, Azores y Madeira). A nivel internacional está presente en varios países, como: Angola, Mozambique, Cabo Verde, S. Tomé y Príncipe, Marruecos y Senegal. Actualmente con sede en Vila de Prado, MEBRA tiene unas instalaciones con una superficie bruta de 20.000 metros cuadrados, representando el area edificada la mitad de este valor.

Desde su fundación, una de las mayores apuestas de MEBRA ha sido la constante innovación tecnológica. La gestión de todos los procesos se orienta hacia el más alto nivel de satisfacción por parte de sus clientes.

MEBRA is a national capital company, focused on distributing solutions in the areas of sanitaryware, water management systems, irrigation systems, HVAC, gas and renewables.

It sports a sales team distributed by all the geographical areas of the country (Mainland, Azores and Madeira). At the international level it's present in several countries, namely Angola, Mozambique, Cape Verde, S. Tomé and Príncipe, Morocco and Senegal.

Currently based in Vila de Prado, Mebra's facilities cover a gross area of 20000 m<sup>2</sup> with its developed area being 10000m<sup>2</sup>.

Since its founding that one of Mebra's biggest bets is on constant technological innovation. The management of all processes is oriented towards the highest level of client satisfaction.

MEBRA, C'est une société, de capital national, focalisée sur la distribution de solutions dans les domaines sanitaires, les systèmes de gestion de l'eau, systèmes d'irrigation, climatisation gaz et énergie.

Elle dispose d'une équipe de vente distribuée dans toutes les zones géographiques du pays (continent, Açores et Madère). Au niveau international elle est présente dans plusieurs pays, dont l'Angola, Mozambique, Cap-Vert, s. Tomé et Príncipe et Maroc.

Actuellement les installations sont localisées à Vila de Prado, sur une surface brute de 20 000 mètres carrés, ce qui représente la zone de déploiement de la moitié de cette valeur. Depuis sa fondation, l'un des plus grands pari de mebra, c'est la constante innovation technologique. La gestion de tous les processus est orientée vers le plus haut niveau de satisfaction de la part de ses clients.





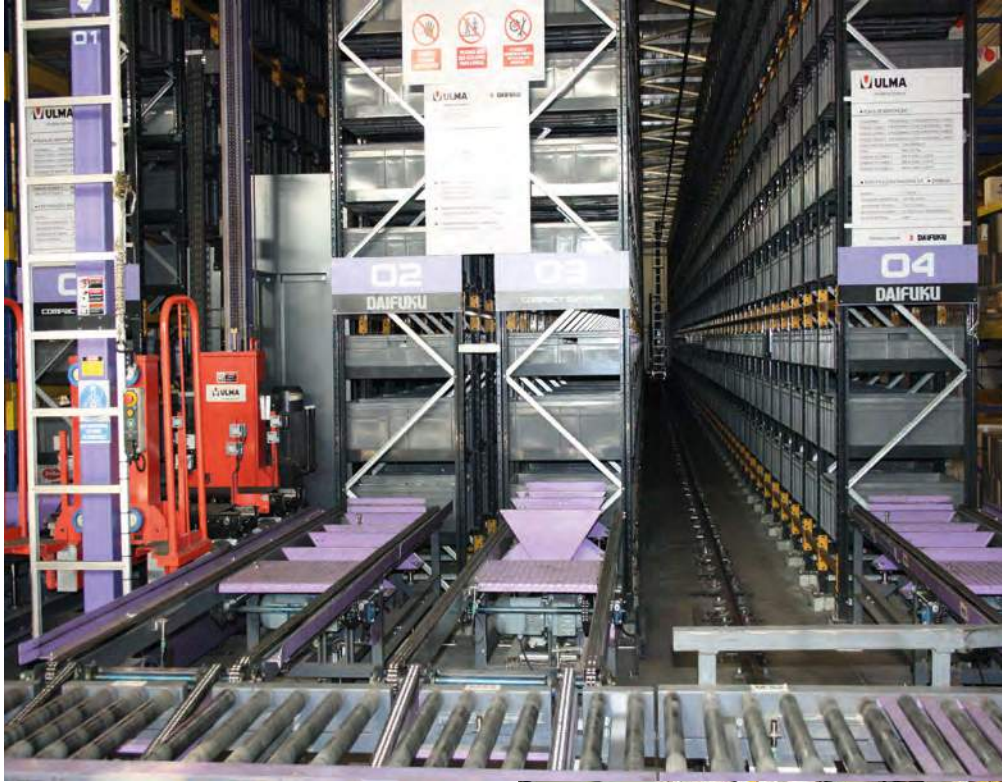

Armazém Robotizado  
Almacém Robotizado  
Robotized Warehouse  
Entrepôt Automatisé



Vista geral Stocks  
Viston General de Stocks  
Stocks General View  
Vue D'ensemble des Stocks





 Manípulo | Mando | Handle | Levier  
 Chuveiro | Ducha | Shower | Douchette  
 Suporte Chuveiro | Soporte Ducha  
 Shower Support | Support Douche  
 Ligação | Flexo | Flexible Hose | Flexible de Douche  
 Prelator | Aireador | Aerator | Aireateur  
 Chuveiro Balcão | Ducha Cocina  
 Kitchen Shower | Douchette Cuisine  
 Cartucho Misturador | Cartucho Mezclador  
 Mixing Cartridge | Cartouche de Mélange  
 Cartucho 1 Água | Cartucho 1 Agua  
 1 Water Cartridge | Cartouche 1 Eau  
 Castelo | Montura | Tap Head | Montara  
 Cartucho Temporizador | Cartucho Temporizador  
 Self-Closing Cartridge | Cartouche Temporisateur  
 Cartucho Termostático | Cartucho Termostático  
 Thermostatic Cartridge | Cartouche Thermostatique  
 Descarga Dupla | Descarga Doble  
 Dual Flush | Double Décharge  
 Kit Fixação | Kit Sujeción | Fixing Set | Set Fixant  
 Ligações | Latiquillos | Mesh Tube | Tuyaux  
 Bica Giratória | Caño Giratorio | Rotating Spout | Bec Rotatic  
 Bica Rebatível | Caño Rebatible  
 Revolving Spout | Bec Rabattable  
 1/4 de Volta | 1/4 de Vuelta | 1/4 Turning | 1/4 Tour  
 Água Potável | Aqua Potable | Drinking Water | Eau Potable  
 Uso Hospitalar | Uso Hospitalario  
 Hospital Use | Utilisation des Hôpitaux  
 Não Requer Mãos | No Requiere de Manos  
 Does Not Require Hands | Ne Nécessite pas de Mains  
 Mobilidade reduzida | Discapacitado  
 Limited Mobility | Handicapé  
 c/ Stop | c/ Stop | w/ Stop | a/ Stop  
 Diferentes Funções Chuveiro | Diferentes Funciones Ducha  
 Different Shower Functions | Différentes Fonctions Douche



 Acabamento | Revestimiento | Coating | Finition  
 Material | Material | Material | Matériel  
 Lt Latão | Latón | Brass | Laiton  
 St Aço Carbono | Acero al Carbono  
 Carbon Steel | Acier Carbone (e = 1,2 mm)  
 Mt Matte | Mate | Matte | Mat  
 ABS Plástico ABS | Plástico ABS | ABS Plastic | Plastique ABS  
 Cb Cobre | Cobre | Copper | Cuivre  
 TF Terra de França | Tierra de Francia  
 Terre de France | Terra de France  
 Tipo de Madeira | Tipo de Madera  
 Wood Type | Type de Bois  
 Iluminação Interior | Iluminación Interior  
 Interior Lightning | Éclairage Intérieur  
 Painel de Controlo | Panel de Control  
 Control Panel | Panneau de Contrôle  
 Coluna(s) de Som | Altavoz | Speaker | Parleur-Haut  
 Potência | Potencia | Power | Puissance  
 Cromoterapia | Cromoterapia  
 Chromotherapy | Chromothérapie  
 Espessura Vidro | Espesura Vidrio  
 Glass Thickness | Épaisseur du Verve  
 Vidro Transparente | Vidrio Transparente  
 Transparent Glass | Verre Transparent  
 Reversível | Reversible | Reversible | Réversible  
 Vidro Temperado | Vidrio Templado  
 Tempered Glass | Verré Tempré  
 Ionizador Oxigénio | Ionizador Oxigéno  
 Oxygen Ionizer | Ioniseur d'Oxyéne  
 Bluetooth | Bluetooth | Bluetooth | Bluetooth  
 Alcance Wifi | Alcance Wifi | Scope Wifi | Partée Wifi  
 Carregador de Bateria USB | Cargador Bateria USB  
 USB Battery Charger | Chargeur de Batterie USB  
 Função Musica | Función Musical  
 Musical Function | Fonction Musicale  
 Chamada Telefónica | Llamada Telefónica  
 Phone Call | Coup de Téléphone  
 Material | Material | Material | Matériel

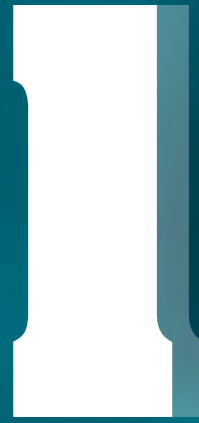

# Sanitários

Sanitarios | Sanitaryware | Produits sanitaires



Para Monocomandos | Para Mezcladores  
For Mixers | Pour Mélangeurs



Dobradiça | Disagra | Hinges | Charnière



Parafusos | Tornillos | Screws | Vis



Raio | Radio | Radius | Rayon



Diâmetro Externo | Diámetro Externo  
Outer Diameter | Diamètre Intérieur



Diâmetro Interno | Diámetro Interno  
Inner Diameter | Diamètre Intérieur



Contacte-nos | Contáctenos | Contact us | Contactez-nous



Sem Furar | Sin Perforar | No Drilling | Sans Perçage



Potência | Potencia | Power | Puissance



Temperatura Máxima | Temperatura Máxima  
Máximum Temperature | Température Maxime



Pressão / Pressão Máxima | Presión / Presión Máxima  
Pressure / Maximum Pressure | Pression / Pression Maxime



Capacidade / Volume | Capacidad / Volumen  
Capacity / Volume | Capacité / Volume



Esquerra/Direita | Izquierda/Derecha  
Left/Right | Gauche/Droite

Anexo com Desenhos Técnicos das Torneiras disponível em [www.mebra.pt](http://www.mebra.pt)  
Anexo con Dibujos Técnicos de los Grifos disponible en [www.mebra.pt](http://www.mebra.pt)  
Attachment with Technical Drawings of all Taps available at [www.mebra.pt](http://www.mebra.pt)  
Annexe avec les Dessins Techniques des Robinets disponible dans [www.mebra.pt](http://www.mebra.pt)



Medida/Cor | Medida/Color  
Measure/Colour | Mesure/Couleur



Cromado/Inox/Branco | Cromo/Inox/Blanco  
Chrome/S. S./White | Chrome/Inox/Blanc

# 1.0

## Torneiras e Componentes

Grifos y Componentes | Taps and Components | Robinets et Composants



## Monocomandos

Monomandos | Mixers | Mitigeurs

## Soft

1631



**Monocomando Banheira**  
Monomando Baño/Ducha  
Bathtub Mixer  
Mitigeur Bain/Douche

1631.0100 **75,00 €** Cr



0753.6052



0757.0001



0167.0500



0176.0100



0110.0175



0762.0927

1632



**Monocomando Chuveiro**  
Monomando Ducha  
Shower Mixer  
Mitigeur Douche

1632.0100 **75,00 €** Cr



0753.6052



0176.0100



0167.0500



0110.0175



0762.0927

1633



**Monocomando Lavatório**  
Monomando Lavabo  
Washbasin Mixer  
Mitigeur Lavabo

1633.0100 **45,00 €** Cr



0753.6052



0757.0301



0755.1506



0105.1035



0762.0928





1634



**Monocomando Bidé**  
 Monomando Bidé  
 Mitigeur Bidet  
 Bidet Mixer

1634.0100 **45,00 €** Cr



1636



**Monocomando Balcão**  
 Monomando Cozinha  
 Kitchen Mixer  
 Mitigeur Cuisine

1636.0100 **60,00 €** Cr

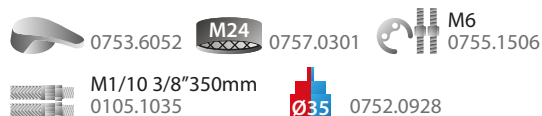

1633a



**Monocomando Lavatório 1 Água**  
 Monomando Lavabo 1 Agua  
 Washbasin Tap 1 Water  
 Robinet Lavabo 1 Eau

1633.0200 **33,00 €** Cr







**1643a**  
**Monocomando Lavatório Alto**  
 Monomando Lavabo Alto  
 High Washbasin Mixer  
 Mitigeur Lavabo Haut

1643.0105 60,00 € 





 0753.6051  0757.0301

 M1/10 3/8"400mm  
 0105.1040  0752.0925



**1641**  
**Monocomando Banheira**  
 Monomando Baño/Ducha  
 Bathtub Mixer  
 Mitigeur Bain/Douche





1641.0100 55,00 € 

 0753.6051  4197.0851  0165.0100  
 0757.0001  4099.0175  0752.0926



**1642**  
**Monocomando Chuveiro**  
 Monomando Ducha  
 Shower Mixer  
 Mitigeur Douche

1642.0100 55,00 € 

 0753.6051  4197.0851  0165.0100  
 4099.0175  0752.0926



**1643**  
**Monocomando Lavatório**  
 Monomando Lavabo  
 Washbasin Mixer  
 Mitigeur Lavabo





1643.0100 34,00 € 

 0753.6051  0757.0301  
 M1/10 3/8"400mm  
 0105.1040  0752.0925



**1644**  
**Monocomando Bidé**  
 Monomando Bidé  
 Bidet Mixer  
 Mitigeur Bidet

1644.0100 34,00 € 

 0753.6051  M1/10 3/8"400mm  
 0105.1040  0757.0401  0752.0925



**1645**  
**Monocomando Balcão**  
 Monomando Cozinha  
 Kitchen Mixer  
 Mitigeur Cuisine

1645.0100 75,00 € 

 0753.6051  0757.0301  
 M1/10 3/8"400mm  
 0105.1040  0752.0905



*bica fundida / caño fundido*  
*casting spout / bec coulé*



1781



### Monocomando Banheira

Monomando Baño/Ducha  
Bathtub Mixer  
Mitigeur Bain/Douche

1781.0100 **180,00 €** Cr



1782



### Monocomando Chuveiro

Monomando Ducha  
Shower Mixer  
Mitigeur Douche

1782.0100 **180,00 €** Cr

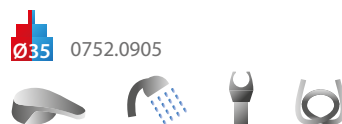

1783



### Monocomando Lavatório

Monomando Lavabo  
Washbasin Mixer  
Mitigeur Lavabo

1783.0100 **110,00 €** Cr

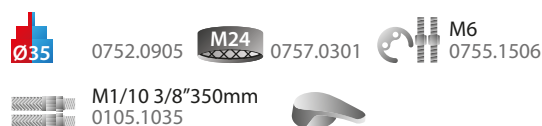

1784



### Monocomando Bidé

Monomando Bidé  
Bidet Mixer  
Mitigeur Bidet

1784.0100 **110,00 €** Cr

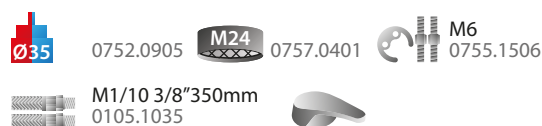

# Monocomandos

Monomandos | Mixers | Mitigeurs



**1771**  
**Monocomando Banheira**  
 Monomando Baño/Ducha  
 Bathtub Mixer  
 Mitigeur Bain/Douche



1771.0100	<b>180,00 €</b>	Cr
1771.5000	<b>180,00 €</b>	Mt



**1772**  
**Monocomando Chuveiro**  
 Monomando Ducha  
 Shower Mixer  
 Mitigeur Douche

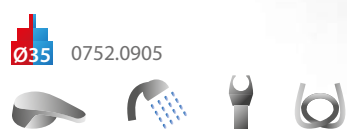

1772.0100	<b>180,00 €</b>	Cr
1772.5000	<b>180,00 €</b>	Mt



**1773**  
**Monocomando Lavatório**  
 Monomando Lavabo  
 Washbasin Mixer  
 Mitigeur Lavabo

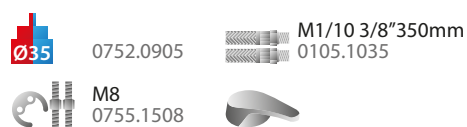

1773.0100	<b>110,00 €</b>	Cr
1773.5000	<b>110,00 €</b>	Mt



**1774**  
**Monocomando Bidé**  
 Monomando Bidé  
 Bidet Mixer  
 Mitigeur Bidet

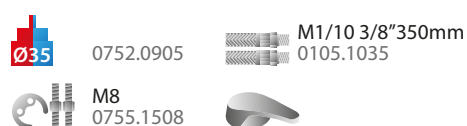

1774.0100	<b>110,00 €</b>	Cr
1774.5000	<b>110,00 €</b>	Mt



**1775**  
**Monocomando Balcão**  
 Monomando Cocina  
 Kitchen Mixer  
 Mitigeur Cuisine



1775.0100	<b>220,00 €</b>	Cr
-----------	-----------------	----



**1776**  
**Torneira Esquadria**  
 Valvula Escuadra  
 Angle Valve  
 Robinet

1776.0100	<b>65,00 €</b>	Cr
1776.5000	<b>65,00 €</b>	Mt

1621



## Monocomando Banheira

Monomando Baño/Ducha  
Bathtub Mixer  
Mitigeur Bain/Douche

1621.0100 **55,00 €** Cr



1622



## Monocomando Chuveiro

Monomando Ducha  
Shower Mixer  
Mitigeur Douche

1622.0100 **55,00 €** Cr

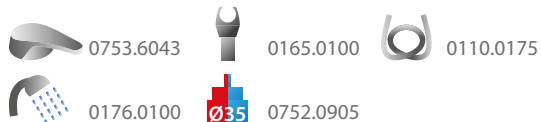

1623



## Monocomando Lavatório

Monomando Lavabo  
Washbasin Mixer  
Mitigeur Lavabo

1623.0100 **43,00 €** Cr

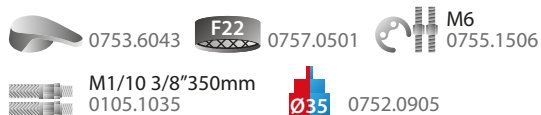

1624



## Monocomando Bidé

Monomando Bidé  
Bidet Mixer  
Mitigeur Bidet

1624.0100 **43,00 €** Cr



1625



## Monocomando Balcão

Monomando Cocina  
Kitchen Mixer  
Mitigeur Cuisine

1625.0100 **63,00 €** Cr



# Monocomandos

Monomandos | Mixers | Mitigeurs

# Point

1793

## Monocomando Lavatório

Monomando Lavabo

Washbasin Mixer

Mitigeur Lavabo

1793.0100

**96,00 €**

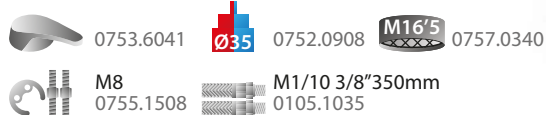

1791

## Monocomando Banheira

Monomando Baño/Ducha

Bathtub Mixer

Mitigeur Bain/Douche

1791.0100

**166,00 €**



1792

## Monocomando Chuveiro

Monomando Ducha

Shower Mixer

Mitigeur Douche

1792.0100

**148,29 €**

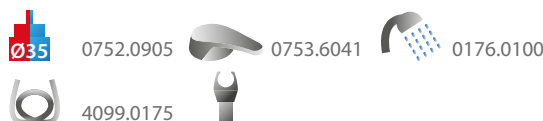

1793a

## Monocomando Lavatório Alto

Monomando Lavabo Alto

High Washbasin Mixer

Mitigeur Lavabo Haut

1793.0101

Bica 120

**149,50 €**



1793.0103

Bica 180

**182,00 €**

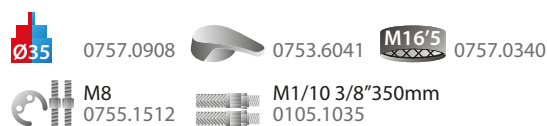

1794

## Monocomando Bidé

Monomando Bidé

Bidet Mixer

Mitigeur Bidet

1794.0100

**96,00 €**

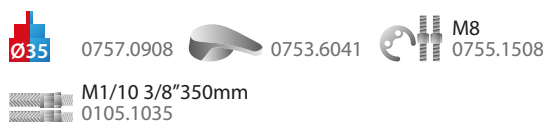

1791a



**Monocomando 2 Vias Encastrar**  
Monomando Empotrar 2 Vías  
Concealed Mixer 2 Ways  
Mitigeur à Encastrer 2 Voies

1791.0101 **167,72 €** Cr



0752.0905



0753.6041

1792a



**Monocomando 1 Via Encastrar**  
Monomando Empotrar 1 Vía  
Concealed Mixer 1 Way  
Mitigeur à Encastrer 1 Voie

1792.0101 **129,00 €** Cr



0752.0905



0753.6041

1793b



**Monocomando Lavatório Encastrar**  
Monomando Empotrar Lavabo  
Concealed Washbasin mixer  
Mitigeur à Encastrer Lavabo

1793.0110 **179,15 €** Cr



0752.0905



0753.6041



0757.0340

1793c



**Monocomando Lavatório Encastrar**  
Monomando Empotrar Lavabo  
Concealed Washbasin Mixer  
Mitigeur à Encastrer Lavabo

1793.0115 **103,00 €** Cr



0752.0905



0753.6041



0757.0340



M8  
0755.1508



M1/10 3/8'350mm  
0105.1035

1794a



**Monocomando Bidé/Sanita Encastar**  
Monomando Bidé/Inodoro Empotrar  
Concealed Bidet/Toilet Mixer  
Mitigeur à Encastrer p/ Bidet

1794.0110 **183,43 €** Cr



0752.0905



0753.6041



0110.1175





1831



### Monocomando Banheira

Monomando Baño/Ducha  
Bathtub Mixer  
Mitigeur Bain/Douche

1831.0100 **60,00 €** Cr



1832



### Monocomando Chuveiro

Monomando Ducha  
Shower Mixer  
Mitigeur Douche

1832.0100 **60,00 €** Cr

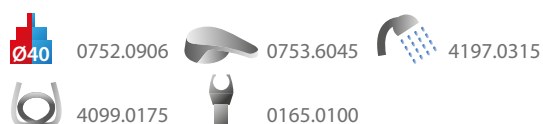

1833



### Monocomando Lavatório

Monomando Lavabo  
Washbasin Mixer  
Mitigeur Lavabo

1833.0100 **35,00 €** Cr



1834



### Monocomando Bidé

Monomando Bidé  
Bidet Mixer  
Mitigeur Bidet

1834.0100 **35,00 €** Cr



1835



### Monocomando Balcão BA

Monomando Cocina BA  
Kitchen Mixer BA  
Mitigeur Cuisine BA

1835.0101 **65,00 €** Cr



1835a



### Monocomando Balcão BL

Monomando Cocina BL  
Kitchen Mixer BL  
Mitigeur Cuisine BL

1835.0105 **65,00 €** Cr

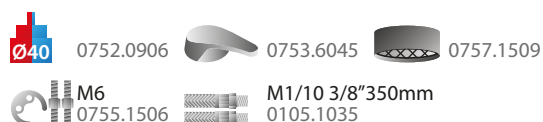



1837



## Monocomando Balcão c/ Chuveiro Retráctil

Momando Cocina Ducha Extraíble  
Pull-out Kitchen Mixer  
Mitigeur Cuisine a/ Douchette

1837.0100 **60,00 €** Cr



0752.0906



0753.6045



0175.0101



M8  
0755.1510



M1/10 3/8\"/>

1838i



## Monocomando Banca Parede

Monomando Fregadero Mural  
Wall-mounted Kitchen Mixer  
Mitigeur Évier Mural

1838.0100 **50,00 €** Cr



0752.0906



0753.6045



M24  
0757.0301



1838s

## Monocomando Banca Parede

Monomando Fregadero Mural  
Wall-Mounted Kitchen Mixer  
Mitigeur Évier Mural

1838.0101 **55,00 €** Cr



0752.0906



0753.6045



M24  
0757.0301



1838



## Monocomando 2 Vias Encastrar

Monomando Empotrar 2 Vías  
Concealed Mixer 2 Ways  
Mitigeur à Encastrer 2 Voies

1838.0400 **100,00 €** Cr



0752.0906



0753.6045

1838a



## Monocomando 1 Via Encastrar

Monomando Empotrar 1 Vía  
Concealed Mixer 1 Way  
Mitigeur à Encastrer 1 Voie

1838.0300 **60,00 €** Cr



0752.0906



0753.6045



**1861**  
**Monocomando banheira**  
 Monomando Baño/Ducha  
 Bathtub mixer  
 Mitigeur Bain/Douche

1861.0100 **49,00 €** Cr



**1862**  
**Monocomando Chuveiro**  
 Monomando Ducha  
 Shower Mixer  
 Mitigeur Douche



1862.0100 **49,00 €** Cr

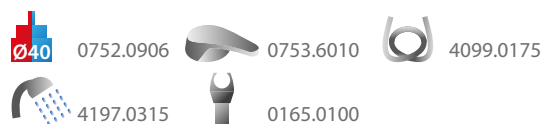

**1863**  
**Monocomando Lavatório**  
 Monomando Lavabo  
 Washbasin Mixer  
 Mitigeur Lavabo



1863.0100 **29,50 €** Cr

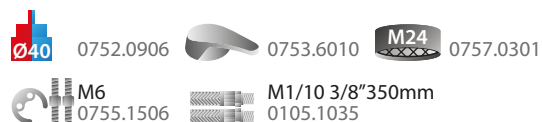

**1864**  
**Monocomando Bidé**  
 Monomando Bidé  
 Bidet Mixer  
 Mitigeur Bidet



1864.0100 **29,50 €** Cr

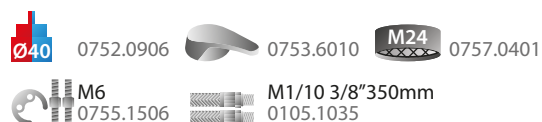

**1865BL**  
**Monocomando Balcão BL**  
 Monomando Cozinha BL  
 Kitchen Mixer BL  
 Mitigeur Cuisine BL



1865.0200 **52,00 €** Cr

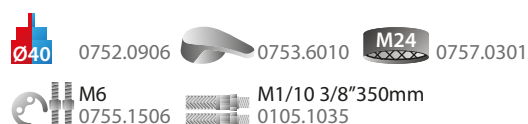

1865



## Monocomando balcão

Monomando cocina  
Kitchen mixer  
Mitigeur cuisine

1865.0100 **52,00 €** Cr

1865.0102 **66,00 €** Cr

bica fundida / caño fundido  
casting spout / bec coulé

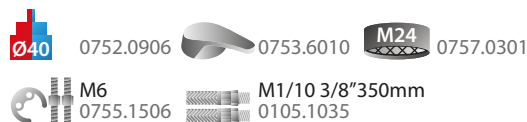

1865 TF



## Monocomando balcão

Monomando cocina  
Kitchen mixer  
Mitigeur cuisine

1865.4000 **75,00 €** TF

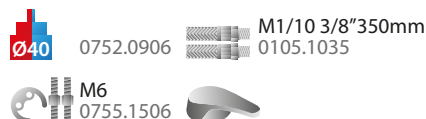

1866



## Monocomando balcão Ita

Monomando cocina Ita  
Kitchen mixer Ita  
Mitigeur cuisine Ita

1866.0101 **31,50 €** Cr

1866.0102 **63,00 €** Cr

bica fundida / caño fundido  
casting spout / bec coulé

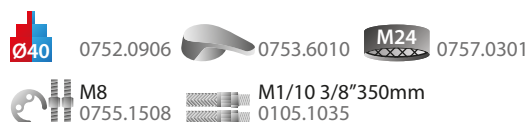

1866 TF



## Monocomando balcão Ita

Monomando cocina Ita  
Kitchen mixer Ita  
Mitigeur cuisine Ita

1866.4001 **65,00 €** TF

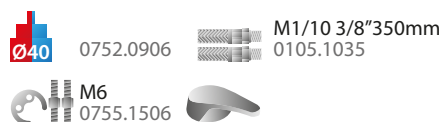

1867



## Monocomando Balcão c/ Chuveiro Retrátil

Monomando Cocina Ducha Extraíble  
Pull-out Kitchen Mixer  
Mitigeur Évier à Douchette

1867.0100 **60,00 €** Cr



1867TF



## Monocomando Balcão c/ Chuveiro Retrátil

Monomando Cocina Ducha Extraíble  
Pull-out Kitchen Mixer  
Mitigeur Évier à Douchette

1867.4000 **100,00 €** TF

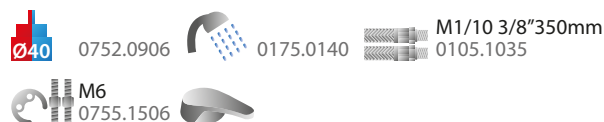

1868i

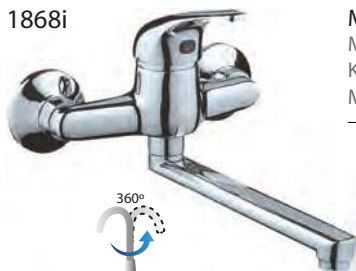

**Monocomando Banca BI**  
 Monomando Fregadero Mural BI  
 Kitchen Mixer BI  
 Mitigeur Cuisine BI

1868.0100 **47,00 €** Cr



0752.0906



0753.6010



0757.0301

1868S



**Monocomando Balcão BS**  
 Monomando Fregadero Mural BS  
 Kitchen Mixer BS  
 Mitigeur Cuisine BS

1868.0110 **48,00 €** Cr



0752.0906



0753.6010



0757.0301

1868SB



**Monocomando Balcão BSB**  
 Monomando Fregadero Mural BSB  
 Kitchen Mixer BSB  
 Mitigeur Cuisine BSB

1868.0115 **48,00 €** Cr



0752.0906



0753.6010



0757.0301

1868BC



**Monocomando 2 Vias Encastrar**  
 Monomando Empotrar 2 Vias  
 Concealed Mixer 2 Ways  
 Mitigeur à Encastrer 2 Voies

1868.0400 **100,00 €** Cr



0752.0906



0753.6010

1868C



**Monocomando 1 Via Encastrar**  
 Monomando Empotrar 1 Vias  
 Concealed Mixer 1 Way  
 Mitigeur à Encastrer 1 Voie

1868.0300 **60,00 €** Cr



0752.0906



0753.6010



**1911**  
**Monocomando Banheira**  
 Monomando Baño/Ducha  
 Bathtub Mixer  
 Mitigeur Bain/Douche

1911.0100 **85,00 €** Cr

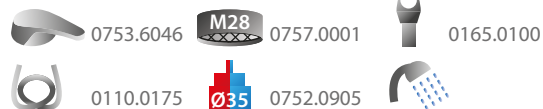

1912



**Monocomando Chuveiro**  
 Monomando Ducha  
 Shower Mixer  
 Mitigeur Douche

1912.0100 **85,00 €** Cr

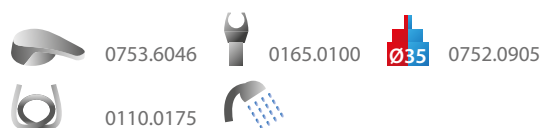

1914



**Monocomando Lavatório**  
 Monomando Lavabo  
 Washbasin Mixer  
 Mitigeur Lavabo

1913.0100 **60,00 €** Cr

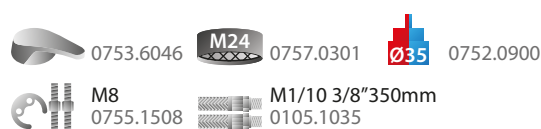

1914



**Monocomando Bidé**  
 Monomando Bidé  
 Bidet Mixer  
 Mitigeur Bidet

1914.0100 **60,00 €** Cr

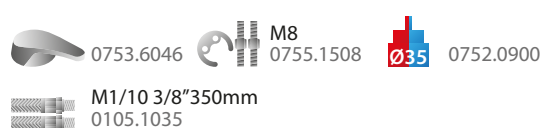

1915



**Monocomando Balcão**  
 Monomando Cozinha  
 Kitchen Mixer  
 Mitigeur Cuisine

1915.0100 **80,00 €** Cr

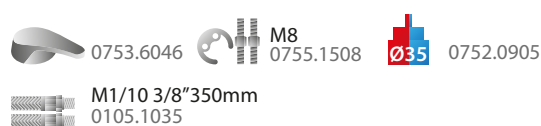





**1801**  
**Monocomando Banheira**  
 Monomando Baño/Ducha  
 Bathtub Mixer  
 Mitigeur Bain/Douche

1801.0100 **80,00 €** Cr

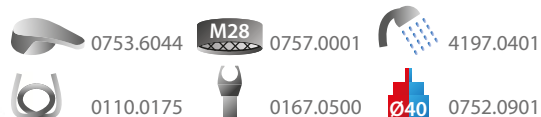

**1802**  
**Monocomando Chuveiro**  
 Monomando Ducha  
 Shower Mixer  
 Mitigeur Douche

1802.0100 **80,00 €** Cr

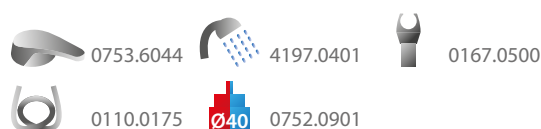

**1803**  
**Monocomando Lavatório**  
 Monomando Lavabo  
 Washbasin Mixer  
 Mitigeur Lavabo

1803.0100 **45,00 €** Cr

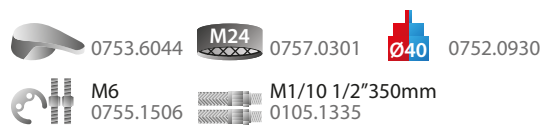

**1804**  
**Monocomando Bidé**  
 Monomando Bidé  
 Bidet Mixer  
 Mitigeur Bidet

1804.0100 **45,00 €** Cr

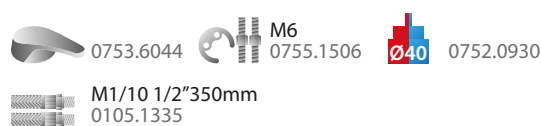





**1805**  
**Monocomando Balcão**  
 Monomando Cocina  
 Kitchen Mixer  
 Mitigeur Cuisine

1805.0100

**60,00 €**



0753.6044



0753.1501



M8  
0755.1508



M1/10 3/8"350mm  
0105.1035



1807



**Monocomando Balcão c/ Chuveiro Retráctil**  
 Monomando Cocina Ducha Extraible  
 Pull-out Kitchen Mixer  
 Mitigeur Cuisine a/ Douchette

1807.0100

**60,00 €**



0753.6044



0752.0906



0175.0101



M8  
0755.1510



M1/10 3/8"350mm  
0105.1035

1808



**Monocomando 2 Vias Encastrar**  
 Monomando Empotrar 2 Vías  
 Concealed Mixer 2 Ways  
 Mitigeur à Encastrer 2 Voies

1808.0400

**100,00 €**



0752.0906



0753.6044

1808a



**Monocomando 1 via Encastrar**  
 Monomando Empotrar 1 Vías  
 Concealed Mixer 1 Way  
 Mitigeur à Encastrer 1 Voie

1808.0300

**60,00 €**



0752.0906



0753.6044

## Monocomando Banheira

Monomando Baño/Ducha

Bathtub Mixer

Mitigeur Bain/Douche

1821.0100 **220,00 €** 

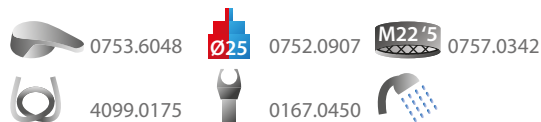

1821



1822



## Monocomando Chuveiro

Monomando Ducha

Shower Mixer

Mitigeur Douche

1822.0100 **214,00 €** 

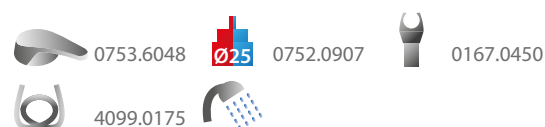

1823



## Monocomando Lavatório

Monomando Lavabo

Washbasin Mixer

Mitigeur Lavabo

1823.0100 **110,00 €** 

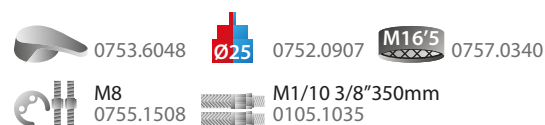

1824



## Monocomando Bidé

Monomando Bidé

Bidet Mixer

Mitigeur Bidet

1824.0100 **110,00 €** 

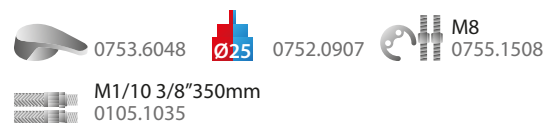

1823a



## Monocomando Lavatório Alto

Monomando Lavabo Alto

High Basin Mixer

Mitigeur Lavabo Haute

1823.0101 **162,00 €** 

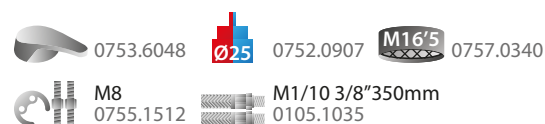

+ 5 cm - 1823.0105  
+ 11 cm - 1823.0106



**Monocomando 2 Vias Encastrear**  
Monomando Empotrar 2 Vías  
Concealed Mixer 2 Ways  
Mitigeur à Encastrer 2 Voies

1821.0101 **175,72 €** Cr



**Monocomando 1 Via Encastrear**  
Monomando Empotrar 1 Via  
Concealed Mixer 1 Way  
Mitigeur à Encastrer 1 Voie

1822.0101 **125,15 €** Cr

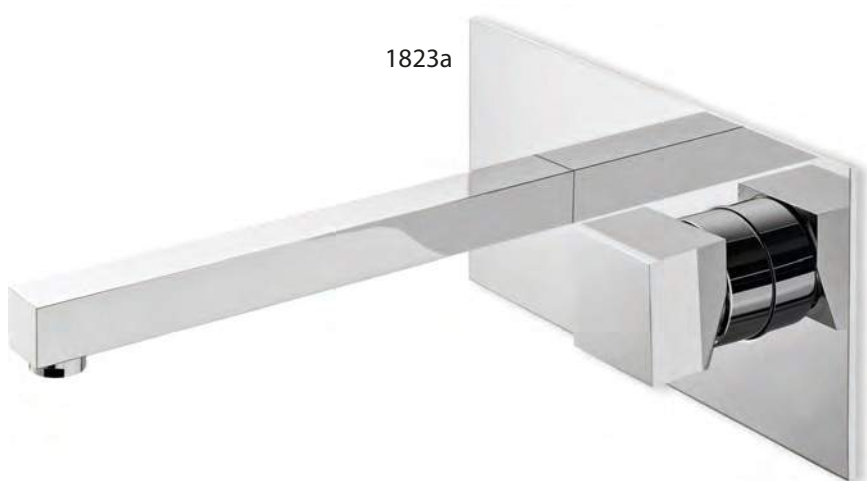

1823a

**Monocomando Lavatório Encastrear**  
Monomando Empotrar Lavabo  
Concealed Washbasin Mixer  
Mitigeur à Encastrer Lavabo

1823.0110 **198,29 €** Cr

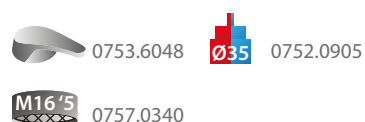

**Monocomando Lavatório Encastrear**  
Monomando Empotrar Lavabo  
Concealed Washbasin Mixer  
Mitigeur à Encastrer Lavabo

1823.0115 **120,00 €** Cr

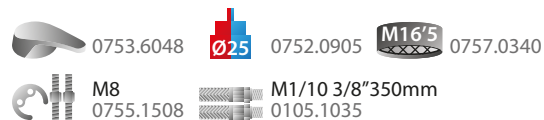

1824a

**Monocomando Bidé/Sanita Encastrear**  
Monomando Bidé/Inodoro Empotrar  
Concealed Bidet/Toilet Mixer  
Mitigeur à Encastrer p/ Bidet

1824.0110 **191,15 €** Cr

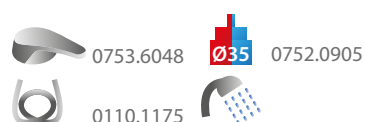

1841



## Monocomando Banheira

Monomando Baño/Ducha  
Bathub Mixer  
Mitigeur Bain/Douche

1841.0100 **90,00 €** Cr



0753.6047



0752.0905



0757.0301



0176.0103



0167.0450



0110.1150

1842



## Monocomando Chuveiro

Monomando Ducha  
Shower Mixer  
Mitigeur Douche

1842.0100 **90,00 €** Cr



0753.6047



0752.0905



0176.0103



0175.0101



0167.0450

1843



## Monocomando Lavatório

Monomando Lavabo  
Washbasin Mixer  
Mitigeur Lavabo

1843.0100 **70,00 €** Cr



0753.6047



0752.0905



0757.0301



M6  
0755.1506



M1/10 3/8"350mm  
0105.1035

1844



## Monocomando Bidé

Monomando Bidé  
Bidet Mixer  
Mitigeur Bidet

1844.0100 **70,00 €** Cr



0753.6047



0752.0905



M8  
0755.1506



M1/10 3/8"350mm  
0105.1035

1843a



**Monocomando Lavatório Alto**  
 Monomando Lavabo Alto  
 High Washbasin Mixer  
 Mitigeur Lavabo Haut

1843.0101 **105,00 €** 

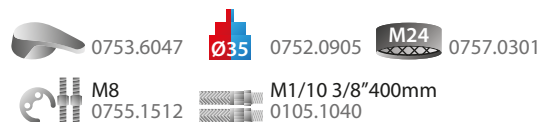

**1845**  
**Monocomando Balcão BC**  
 Monomando Cocina BC  
 Kitchen Mixer BC  
 Mitigeur Cuisine BC

1845.0100 **80,00 €** 

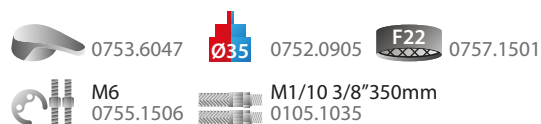

1845a



**Monocomando Balcão BQ**  
 Monomando Cocina BQ  
 Kitchen Mixer BQ  
 Mitigeur Cuisine BQ

1845.0101 **90,00 €** 

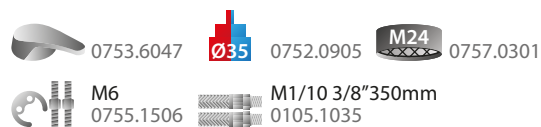



**1671**  
**Monocomando Banheira**  
 Monomando Baño/Ducha  
 Mitigeur Bain/Douche  
 Bathtub Mixer

1671.0100 **80,00 €** Cr

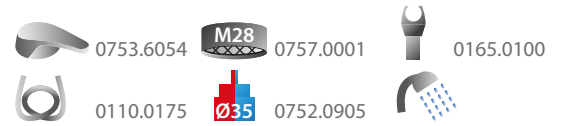

1672



**Monocomando Chuveiro**  
 Monomando Ducha  
 Shower Mixer  
 Mitigeur Douche

1672.0100 **80,00 €** Cr

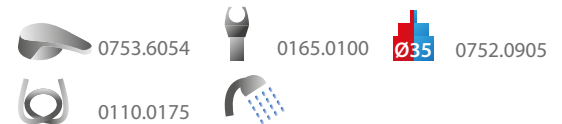

1673



**Monocomando Lavatório**  
 Monomando Lavabo  
 Washbasin Mixer  
 Mitigeur Lavabo

1673.0100 **60,00 €** Cr

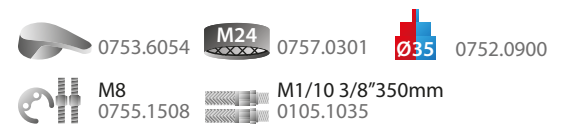

1674



**Monocomando Bidé**  
 Monomando Bidé  
 Bidet Mixer  
 Mitigeur Bidet

1674.0100 **60,00 €** Cr

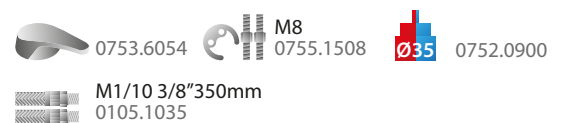

1675



**Monocomando Balcão**  
 Monomando Cocina  
 Kitchen Mixer  
 Mitigeur Cuisine

1675.0100 **80,00 €** Cr

bica fundida / caño fundido  
 casting spout / bec coulé

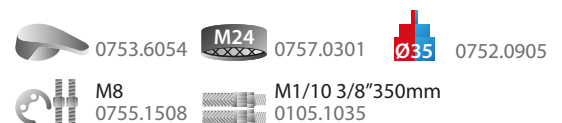





**Monocomando Banheira**  
Monomando Baño/Ducha  
Bath tub Mixer  
Mitigeur Bain/Douche

1661.0100 **85,00 €** Cr



**Monocomando Chuveiro**  
Monomando Ducha  
Shower Mixer  
Mitigeur Douche

1662.0100 **85,00 €** Cr

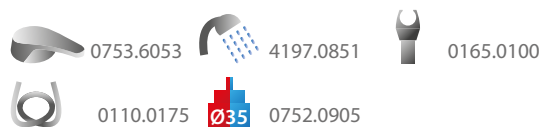

1663

**Monocomando Lavatório**  
Monomando Lavabo  
Washbasin Mixer  
Mitigeur Lavabo

1663.0100 **70,00 €** Cr

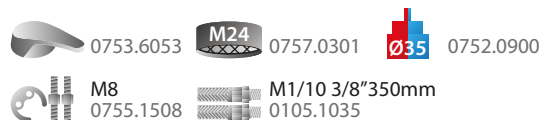

1664

**Monocomando Bidé**  
Monomando Bidé  
Bidet Mixer  
Mitigeur Bidet

1664.0100 **70,00 €** Cr

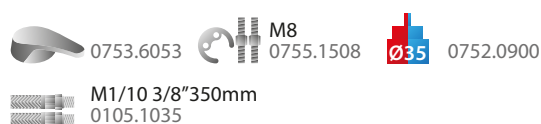

1665

**Monocomando Balcão**  
Monomando Cozinha  
Kitchen Mixer  
Mitigeur Cuisine

1665.0100 **90,00 €** Cr





**Monocomando Banheira**  
 Monomando Baño/Ducha  
 Bathtub Mixer  
 Mitigeur Bain/Douche

1531.0100

**57,00 €**



4197.0851



4099.0175



0165.0100



0757.0301



0752.0908



**Monocomando Chuveiro**  
 Monomando Ducha  
 Shower Mixer  
 Mitigeur Douche

1532.0100

**57,00 €**



4197.0851



4099.0175



0165.0100



0752.0908





**Monocomando Lavatório**  
Monomando Lavabo  
Washbasin Mixer  
Mitigeur Lavabo

**M24** 0757.0301 **Ø35** 0752.0908

**M1/10 3/8"350mm**  
0105.1035

1533.0100 **37,00 €** **Cr**



**Monocomando Bidé**  
Monomando Bidé  
Bidet Mixer  
Mitigeur Bidet

**F22** 0753.1501 **Ø35** 0752.0908

**M1/10 3/8"350mm**  
0105.1035

1534.0100 **37,00 €** **Cr**



# Monocomandos

Monomandos | Mixers | Mitigeurs

# GROVE



**Monocomando Banheira**  
Monomando Baño/Ducha  
Bathtub Mixer  
Mitigeur Bain/Douche

1541.0100    **35,00 €**    Cr    XX



**Monocomando Chuveiro**  
Monomando Ducha  
Shower Mixer  
Mitigeur Douche

1542.0100    **32,00 €**    Cr    XX



**Monocomando Bidé**  
Monomando Bidé  
Bidet Mixer  
Mitigeur Bidet

1544.0100    **24,00 €**    Cr    XX



**Monocomando Lavatório**  
Monomando Lavabo  
Washbasin Mixer  
Mitigeur Lavabo

1543.0100    **24,00 €**    Cr    XX





# Monocomandos

Monomandos | Mixers | Mitigeurs

# GROVE

## Monocomando Balcão

Monomando Cocina

Kitchen Mixer

Mitigeur Cuisine



1545.0100

32,00 €



XX



## Monocomando Balcão Ita

Monomando Cocina Ita

Kitchen Mixer Ita

Mitigeur Cuisine Ita



1546.0101

23,00 €



XX



## Monocomando Balcão c/ Chuveiro Retrátil

Monomando Cocina Ducha Extraible

Pull-out Kitchen Mixer

Mitigeur Évier à Douchette



1547.0100

45,00 €



XX



## Monocomando Balcão BA

Monomando Cocina BA

Kitchen Mixer BA

Mitigeur Cuisine BA



1545.0101

34,00 €



XX



## Monocomando Banca BS

Monomando Fregadero Mural BS

Kitchen Mixer BS

Mitigeur Cuisine BS



1548.0110

34,00 €



XX



## Monocomando Banca BI

Monomando Fregadero Mural BI

Kitchen Mixer BI

Mitigeur Cuisine BI



1548.0100

33,00 €



XX

# Monocomandos Balcão

Monomandos Cocina  
Kitchen Mixers  
Mitigeurs Évier



BS211

Monocomando Balcão c/ Chuveiro  
Monomando Cocina c/ Ducha  
Kitchen Mixer w/ Shower  
Mitigeur Cuisine a/ Douche

0211.0240

175,00 €

Cr



M1/10 3/8" 450mm  
0105.1040



M8



0752.0905





# Monocomandos Balcão

Monomandos Cocina | Kitchen Mixers | Mitigeurs Évier

Mi211

**DISCONTINUADO**

Monocomando Balcão c/ Chuveiro 75  
Monomando Cocina c/ Ducha 75  
Kitchen Mixer w/ Shower 75  
Mitigeur Cuisine a/ Douchette 75

Ø40 0752.0906 0211.0601 0211.0902 0755.1506

M1/10 3/8" 400mm  
0103-1040

0211.0218 **215,00 €** Cr



LB8013

**DISCONTINUADO**

Monocomando Balcão Joystick  
Monomando Cocina Joystick  
Kitchen Mixer Joystick  
Mitigeur Cuisine Joystick

Ø40 0752.0915 0211.0605 0211.0902 0755.1506

M6 M1/10 3/8" 400mm  
0103-1040

0211.0219 **105,00 €** Cr



LB8012

**DISCONTINUADO**

Monocomando Balcão c/ Mola  
Monomando Cocina c/ Muelle  
Kitchen Mixer w/ Spring  
Mitigeur Cuisine a/ Resort

Ø40 0752.0906 0211.0605 0211.0902 0755.1506

M6 M1/10 3/8" 400mm  
0103-1040

0211.0221 **72,00 €** Cr



LB8001-2

**DISCONTINUADO**

Monocomando Balcão c/ Chuveiro 45  
Monomando Cocina c/ Ducha 45  
Kitchen Mixer w/ Shower 45  
Mitigeur Cuisine a/ Douchette 45

Ø40 0752.0906 0211.0601 0211.0902 0755.1506

M1/10 3/8" 400mm  
0103-1040

0211.0222 **150,00 €** Cr





**211MF**  
 Monocomando Balcão c/ Mola Mini  
 Monomando Cocina c/ Muelle Mini  
 Kitchen Mixer w/ Spring Mini  
 Mitigeur Cuisine a/ Ressort Mini

---

0211.0267    **80,00 €**    Cr

M8 0755.1508    M1/10 1/2"350mm 0105.1035

Ø25 0752.0907



**BZ211**  
 Monocomando Balcão c/ Mola Ziro  
 Monomando Fregadero c/ Muelle Ziro  
 Kitchen Sink Mixer w/ Spring Ziro  
 Mitigeur Cuisine a/ Ressort Ziro

0211.0259    **140,00 €**    Cr

Ø35 0752.0905    M1/10 3/8 350mm 0105.1035



**BM211**  
 Monocomando Balcão Mito  
 Monomando Fregadero Mito  
 Kitchen Mixer Mito  
 Mitigeur Cuisine Mito

0211.0258    **80,00 €**    Cr

Ø40 0752.0906    F22 0757.1501    M1/10 3/8"350mm 0105.1035



M6 0755.1506



**BR1870**  
 Monocomando Balcão Bica Rebatível  
 Monomando Fregadero Caño Abatible  
 Revolving Spout Sink Mixer  
 Mitigeur Cuisine Bec Rabattable

1870.1200    **70,00 €**    Cr

Ø40 0752.0906    F22 0757.1501    M1/10 3/8"350mm 0105.1035

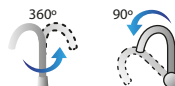





**BX211**  
**Monocomando Balcão Inox**  
 Monomando Cocina Inox  
 S. S. Kitchen Mixer  
 Mitigeur Cuisine Inox

0211.0255 **130,00 €** Cr

 M6 0755.1506  Ø35 0752.0905

 M1/10 3/8"400mm 0105.1040 



**BL211**  
**Monocomando Balcão Line**  
 Monomando Cocina Line  
 Kitchen Mixer Line  
 Mitigeur Cuisine Line

0211.0245 **100,00 €** Cr

 Ø35 0752.0905  M24 0757.0301





 M1/10 3/8"350mm 0105.1035



**211RL**  
**Monocomando Balcão Retrátil**  
 Monomando Cocina Extraible  
 Pull-out Kitchen Mixer  
 Mitigeur Évier a/ Douchette

0211.0265 **72,00 €** Cr

 Ø40 0752.0906  M6 0755.1506  M1/10 3/8"350mm 0105.1035



**211FO**  
**Monocomando Balcão 3 Vias**  
 Monomando Cocina 3 Vías  
 Kitchen Mixer 3 Way  
 Mitigeur Cuisine 3 Voies

0211.0257 **95,00 €** Cr

 Ø35 0752.0905  M8 0755.1508  M1/10 3/8"350mm 0105.1035

Filtração - osmose | Filtración - ósmosis  
 Filtration - osmose | Filtration - osmose





**vidral**

### Torneira Lavatório Temporizada

Grifo Lavabo Temporizado  
Self-Closing Basin Tap  
Robinet Temporisé Lavabo

0212.1414 **40,00 €** Cr

**M24** 0757.0301



**vidral**

### Torneira Mural Temporizada

Grifo Mural Temporizado  
Wall Mounted Self-Closing Tap  
Robinet Temporisé Murale

0212.1411 **40,00 €** Cr

**M24** 0757.0301



**vidral**

### Torneira Urinol Temporizada

Grifo Urinario Temporizado  
Self-Closing Urinal Tap  
Robinet Temporisé Urinaire

0212.1416 **41,00 €** Cr



### 903L Torneira Lavatório Cotovelo

Grifo Lavabo Medical  
Basin Medical Tap  
Robinet Lavabo a/ Manette Clinique

0211.0200 **23,00 €** Cr

**M24** 0753.9902

**M24** 0757.0301

**M24** 0752.0701



### 904L Torneira Banca Cotovelo

Grifo Mural Medical  
Wall-Mounted Medical Tap  
Robinet Mural a/ Manette Clinique

0211.0199 **23,00 €** Cr

**M24** 0753.9902

**M24** 0752.0701



### 211TP Torneira Pedal

Grifo Pedal  
Foot Operated Tap  
Robinet à Pédale

0211.0101 **75,00 €** Cr

Água fria ou pré-misturada  
Agua fria o pre-mesclada  
Cold water or pre-mixed  
Eau froide ou pré-mixte





LC0211



## Monocomando Lavatório Cotovelo

Monomando Lavabo Medical  
Basin Medical Mixer  
Mitigeur Lavabo a/ Manette Clinique

0211.0214 **52,50 €**

0753.9906 0752.0906 0757.0301  
 M1/10 3/8"350mm  
0105.1035

211BC



## Monocomando Balcão Cotovelo

Monomando Cozinha Medical  
Kitchen Medical Mixer  
Mitigeur Cuisine a/ Manette Clinique

0211.0220 **50,00 €**



0753.9903 0752.0906 0757.0301  
 M6 0755.1506 M1/10 3/8"350mm  
0105.1035

211Bi



## Monocomando Banca Cotovelo

Monomando Mural Medical  
Wall-mounted Medical Mixer  
Mitigeur Mural a/ Manette Medical

0211.0230 **60,00 €**



0753.9903 0752.0906 0757.0301

211CC



## Monocomando Chuveiro Cotovelo

Monomando Ducha Medical  
Medical Shower Mixer  
Mitigeur Douche a/ Manette Medical

0211.0217 **60,00 €**

0753.9903 0752.0906 4197.0315  
 4099.0175 0165.0100

# Torneiras

Grifos | Taps | Robinetes



**34601**  
Torneira Temporizada Lavatório 605  
Grifo Lavabo Temporizado 605  
Basin Self-Closing Tap 605  
Robinet Temporisé Lavabo 605

0208.0001 **66,61 €** Cr



0208.0265



**31706**  
Torneira Temporizada Urinol 12A  
Grifo Urinario Temporizado 12A  
Self-Closing Urinol Tap 12A  
Robinet Urinoir Temporisé 12A

0208.0097 **66,07 €** Cr



0208.0315



**31709**  
Torneira Temporizada Urinol Encastrar 27  
Grifo Urinario Temporizada Empotrar 27  
Concealed Self-Closing Urinal Tap 27  
Robinet Urinoir Temporisé à Encastré 27

0208.0100 **51,07 €** Cr



0208.0315



**65010**  
Torneira Temporizada Chuveiro 65  
Grifo Ducha Temporizado 65  
Self-Closing Shower Tap 65  
Robinet Douche Temporisé 65

0208.0059 **75,02 €** Cr



0208.0306



**29305**  
Chuveiro Antivandalismo  
Rociador Anti-Vandálico  
Vandal-Proof Shower  
Douche Anti-Vandalisme

0208.0070 **63,16 €** Cr



**55010**  
Torneira Temporizada Chuveiro Encastrar 55  
Grifo Ducha Temporizada Empotrar 55  
Concealed Self-Closing Shower Tap 55  
Robinet Douche Temporisé à Encastré 55

0208.0055 **71,28 €** Cr



0208.0306



**14109**  
Fluxómetro Sanita 1000M  
Fluxor Inodoro 1000M  
Toilet Flushvalve 1000M  
Robinet de Chasse 1000M

0208.0104 **69,13 €** Cr



**79000**  
Torneira Electrónica Infravermelhos L  
Grifo Electrónico Infra Rojos  
Infra-Red Electronic Tap  
Robinet Électronique Infrarouge

Ref. **€/Un.**

0208.0200 **306,12 €**

0208.0197 **306,12 €**



# Torneiras

Grifos | Taps | Robinets



**08210**  
Torneira Temporizada Lavatório Modern  
Grifo Lavabo Temporizado Modern  
Basin Self-Closing Tap Modern  
Robinet Temporisé Lavabo Modern

0212.1406 **59,50 €** Cr



**08212**  
Misturadora Lavatório Temporizada Modern  
Mesclador Lavabo Temporizado Modern  
Self-Closing Basin Mixer Modern  
Mitigeur Temporisé Lavabo Modern

0212.1408 **117,67 €** Cr



**08132**  
Misturadora Chuveiro Temporizada  
Mesclador Ducha Temporizado  
Self-Closing Shower Mixer  
Mitigeur Douche Temporisé

0212.1430 **212,81 €** Cr



**08140/E**  
Torneira Chuveiro Temporizada  
Grifo Ducha Temporizado  
Self-Closing Shower Tap  
Robinet Douche Temporisé

0212.1435 **61,00 €** Cr



**09036**  
Chuveiro Antivandalismo  
Rociador Anti-Vandálico  
Vandal-Proof Shower  
Douche Anti-Vandalisme

0212.1445 **70,00 €** Cr



**02178**  
Torneira Fontanário c/ Pulsante  
Grifo Bebedero c/ Pulsador  
Drinking Fountain Tap  
Robinet p/ Fontaine a/ Pousoir

0212.1486 **70,70 €** Cr



**02061**  
Torneira Pedal  
Grifo Pedal  
Foot Operated Tap  
Robinet à Pédale

0212.1501 **113,42 €** Cr



**02070**  
Misturadora Pedal  
Mezclador Pedal  
Foot Operated Mixer  
Mitigeur à Pédale

0212.1505 **169,42 €** Cr



**02066**  
Misturadora 2 Pedais  
Mezclador 2 Pedales  
Double Foot Operated Mixer  
Mitigeur 2 Pédales

0212.1503 **170,81 €** Cr



**02115**  
Torneira Pavimento  
Grifo Pavimento  
Floor Tap  
Robinet Sol

0212.1508 **89,61 €** Cr



# Torneiras

Grifos | Taps | Robinets

# BENKISER



**8453902**  
Fluxómetro 3/4" WC  
Fluxor Inodoro 3/4"  
Flush Valve 3/4" WC  
Robinet de Chasse 3/4"



0212.0102 **90,00 €**



**8283904**  
Fluxómetro 3/4"  
Fluxor 3/4"  
Flush Valve 3/4"  
Robinet de Chasse 3/4"



0212.0104 **95,00 €**



**6662200**  
Fluxómetro Urinol  
Fluxor Urinário  
Urinal Flush Valve  
Robinet de Urinoir



0212.0117 **120,00 €**



**8883301**  
Fluxómetro 3/4"  
Fluxor 3/4"  
Flush Valve 3/4"  
Robinet de Chasse 3/4"



0212.0109 **105,00 €**

# Acessórios

Accessorios | Accessories | Accessoires



**186EF**  
Emboque Fluxometro  
Junta Fluxor  
Flush Valve Mouth Piece  
Embout p/ Robinet de Chasse

**Ref.** **€/Un.**

0186.0105 p/p/s/p **1,60 €** 50

0186.0106 g/g/b/g **1,60 €** 50



**186EU**  
Emboque Urinol Borracha  
Junta Goma Urinario  
Urinal Rubber Mouth Piece  
Embout p/ Urinoir Caoutchouc

**Ref.** **€/Un.**

0186.0005 p/p/s/p **1,25 €** 10

0186.0006 g/g/b/g **1,25 €** 10



**188CU**  
Concha Urinol  
Concha Urinario  
Urinal Shell  
Coquille Urinoir



**Ref.** **€/Un.**

0188.0106 **4,30 €** 5



**182EI**  
Emboque Urinol  
Campana Urinario  
Urinal Mouth Piece  
Embout p/ Urinoir



**Ref.** **€/Un.**

0187.0106 **2,10 €** 5



**213TL**  
Tubo Fluxometro em L  
Tubo Fluxor L  
Flush Valve Pipe L  
Tuyau p/ Robinet de Chasse L



**Ref.** **€/Un.**

0213.0106 Ø28 60x15 **20,00 €**

0213.0109 Ø28 70x15 **22,00 €**

0213.0101 Ø28 80x15 **25,00 €**

0213.0108 Ø28 90x15 **27,00 €**

0213.0107 Ø28 100x15 **30,00 €**

0213.0104 Ø32 60x15 **24,00 €**



**213TD**  
Tubo Direito  
Tubo Recto  
Straight Pipe  
Tuyau Droit



**Ref.** **€/Un.**

0213.0204 Ø28 100 **28,00 €**

0213.0205 Ø32 100 **35,00 €**



**213TP**  
Tubo Fluxometro  
Tubo Fluxor  
Flush Valve Pipe  
Tuyau p/ Robinet de Chasse



**Ref.** **€/Un.**

0213.0105 Ø28 60x15 **22,00 €**

0213.0110 Ø28 70x15 **24,00 €**

0213.0111 Ø28 75x15 **25,00 €**

0213.0113 Ø28 100x15 **30,80 €**

# 1 Água

1 Agua | 1 Water | 1 Eau

1633a



**Monocomando Lavatório 1 Água Soft**  
Monomando Lavabo 1 Agua Soft  
Washbasin Tap 1 Water Soft  
Robinet Lavabo 1 Eau Soft

1633.0200 **33,00 €** Cr

M24 0753.6043



ML1870



**Monocomando Lavatório 1 Água**  
Monomando Lavabo 1 Agua  
Washbasin Tap 1 Water  
Robinet Lavabo 1 Eau

1870.1000 **22,00 €** Cr

M24 0757.0301



0752.0899

MB1870



**Monocomando Banca 1 Água**  
Monomando Mural 1 Agua  
Wall-mounted Tap 1 Water  
Robinet Mural 1 Eau

1870.1100 **22,00 €** Cr

M24 0757.0301



0752.0899

TL1870



**Torneira Lavatório 1 Água**  
Grifo Lavabo 1 Agua  
Basin tap 1 water  
Robinet Lavabo 1 Eau

1870.1150 **22,00 €** Cr



M24 0757.0301



0752.0701

M1/10 3/8"350mm  
0105.1035

MT187



**Monocomando Balcão 1 Água BL**  
Grifo Cocina 1 Agua BL  
Kitchen Tap 1 Water BL  
Robinet Cuisine 1 Eau BL

1870.1175 **23,00 €** Cr



F22 0757.1501



MB1869



**Monocomando Giratório Balcão 1 Água**  
Grifo Cocina Giratorio 1 Agua  
Kitchen Tap 1 Water  
Robinet Cuisine 1 Eau

1869.0100 **23,00 €** Cr



F22 0757.1501



0752.0898

# Termostáticas

Termostática | Thermostatic | Thermostatique



**Misturadora Banheira Termostática**  
Mezcladora Termostática Baño/Ducha  
Thermostatic Bathtub Mixer  
Robinet Thermostatique Bain/Douche

0211.0421 **130,00 €** Cr



**Misturadora Chuveiro Termostática**  
Mezcladora Termostática Ducha  
Thermostatic Shower Mixer  
Robinet Thermostatique Douche

0211.0422 **95,00 €** Cr

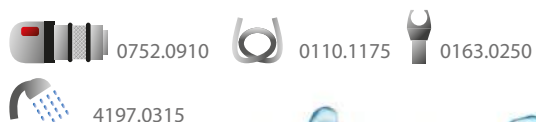

**Misturadora Termostática 2 Vias Encastrar**  
Mezcladora Termostática 2 Vias Empotrar  
Thermostatic 2 Ways Concealed Mixer  
Robinet Thermostatique 2 Voies à Encastrer

0211.0465 **270,00 €** Cr



**Misturadora Termostática 1 Via Encastrar**  
Mezcladora Termostática 1 Via Empotrar  
Thermostatic 1 Way Concealed Mixer  
Robinet Thermostatique 1 Voie à Encastrer

0211.0460 **238,00 €** Cr

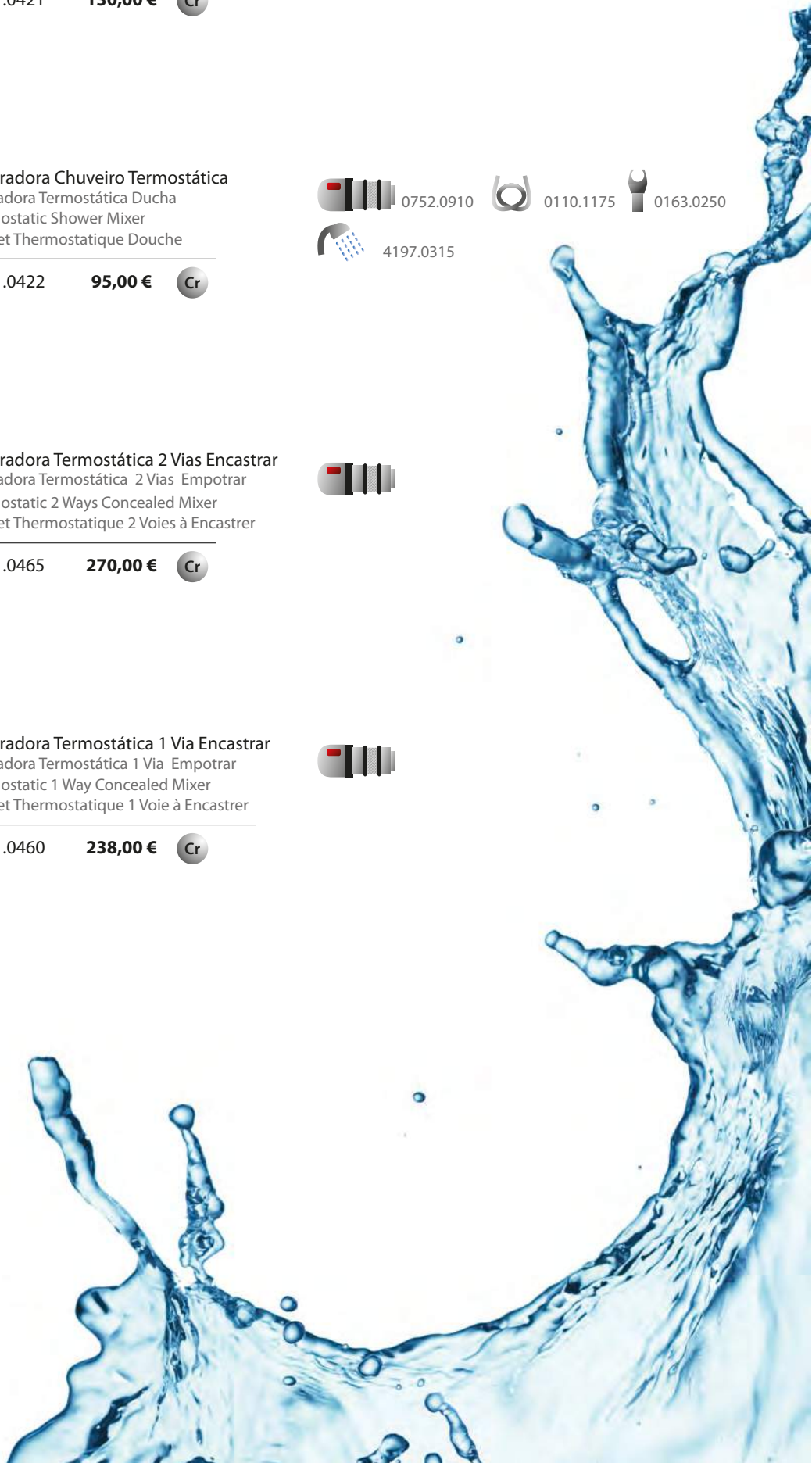

2901



**Misturadora Banheira**  
Grupo Baño/Ducha  
Double Handle Bathtub Mixer  
Melangeur Bain/Douche

2901.0110 **75,00 €** Cr

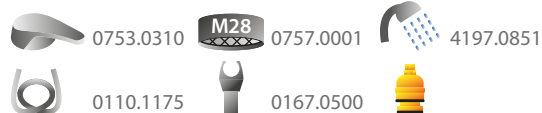

2902



**Misturadora Chuveiro**  
Grupo Ducha  
Double Handle Shower Mixer  
Melangeur Douche

2902.0110 **75,00 €** Cr

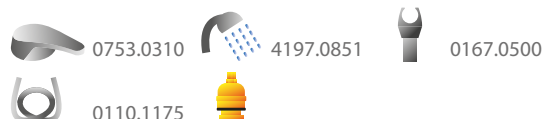

2903



**Monobloco Lavatório**  
Monobloc Lavabo  
Double Handle Basin Mixer  
Melangeur Lavabo

2903.0110 **55,00 €** Cr

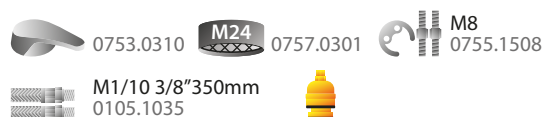

2904



**Monobloco Bidé**  
Monobloc Bidé  
Double Handle Bidet Mixer  
Melangeur Bidet

2904.0110 **55,00 €** Cr

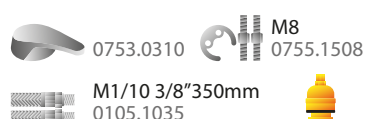

2905

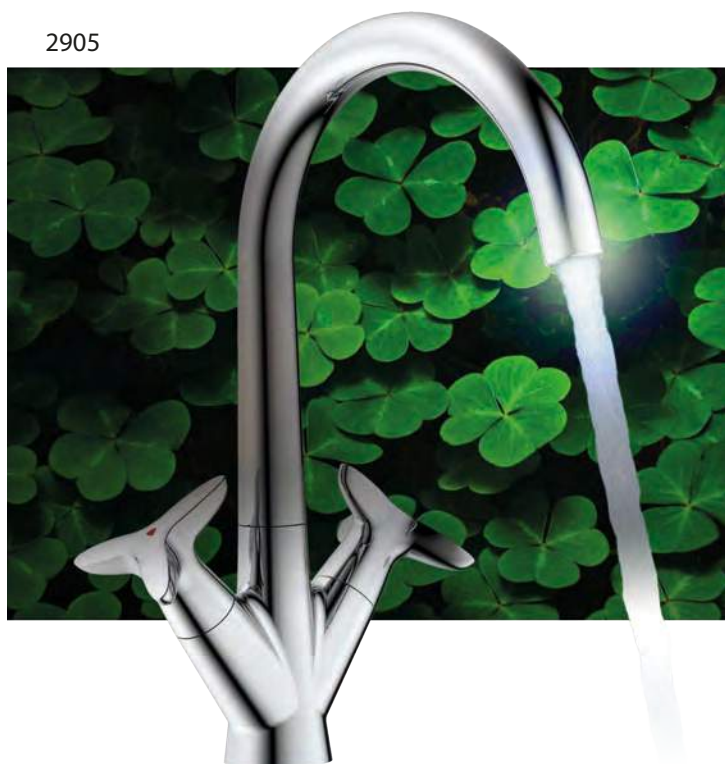

**Monobloco Balcão**  
Monobloc Fregadero  
Double Handle Kitchen Mixer  
Melangeur Évier

2905.0110 **70,00 €** Cr

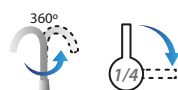
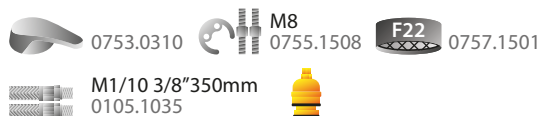



2201



## Misturadora Banheira

Grupo Baño/Ducha  
Double handle Bathtub Mixer  
Melangeur Bain/Douche

2201.0100 **50,00 €** 

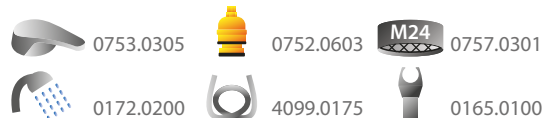

2202



## Misturadora Chuveiro

Grupo Ducha  
Double Handle Shower Mixer  
Melangeur Douche

2202.0100 **40,00 €** 

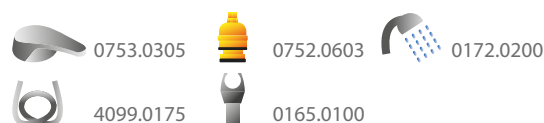

2203



## Monobloco Lavatório

Monobloc Lavabo  
Double Handle Basin Mixer  
Melangeur Lavabo

2203.0100 **40,00 €** 

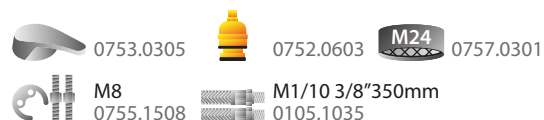

2204



## Monobloco Bidé

Monobloc Bidé  
Double Handle Bidet Mixer  
Melangeur Bidet

2204.0100 **40,00 €** 

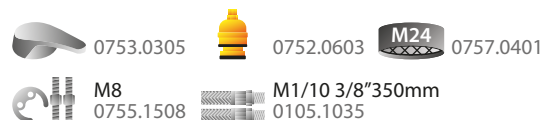

2205



## Monobloco Balcão

Monobloc Fregadero  
Double Handle Kitchen Mixer  
Melangeur Évier

2205.0100 **45,00 €** 

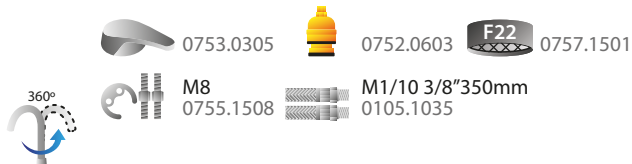

2208



**Misturadora Banca**  
Bateria Fregadero  
Double Handle Wall Sink Mixer  
Melangeur Cuisine Mural

2208.0100 **40,00 €** Cr



0753.0305



0752.0603



0757.1501

2210



**Torneira Lavatório**  
Grifo Lavabo  
Basin Tap  
Robinet Lavabo

2210.0100 **16,00 €** Cr



0753.0305



0752.0603



0757.1501

2211



**Torneira Banca**  
Grifo Mural  
Wall Mounted Tap  
Robinet Mural

2211.0103 1/2 **15,00 €** Cr

2211.0104 3/4 **18,00 €** Cr



0753.0305



0752.0603

2212



**Torneira Giratória Balcão**  
Grifo Giratorio Vertical  
High Swivel Spout Tap  
Robinet Bec Tournant

2212.0100 **22,00 €** Cr



0753.0305



0752.0603



0757.1501

2213



**Torneira Giratória Parede**  
Grifo Giratorio Mural  
Wall Swivel Spout Tap  
Robinet Bec Tournant Mural

2213.0100 **17,00 €** Cr



0753.0305



0752.0603



0757.1501

2214



### Torreia Esquadria

Llave Escuadra  
AngleTap  
Robinet Angle



0753.0305



0752.0603

2214.0102	1/2 x 3/8	<b>14,00 €</b>	Cr
2214.0103	1/2 x 1/2	<b>14,00 €</b>	Cr
2214.0104	1/2 x 3/4	<b>14,00 €</b>	Cr

2215



### Torreia Máquina Lavar

Grifo Lavadora  
Washing Machine Tap  
Robinet p/ Machine à Laver



0753.0305



0752.0603

2215.0100		<b>15,00 €</b>	Cr
-----------	--	----------------	----

2216



### Torreia Dupla R/R

Grifo Doble R/R  
Double Tap R/R  
Robinet Double R/R



0753.0305



0752.0603

2216.0100		<b>25,00 €</b>	Cr
-----------	--	----------------	----

2217



### Torreia Dupla R/B

Grifo Doble R/B  
Double Tap R/B  
Robinet Double R/B



0753.0305



0752.0603

2217.0100		<b>22,00 €</b>	Cr
-----------	--	----------------	----

2219



### Torreia Passagem

Cabezal Llave de Paso  
Concealed Head Tap  
Tête de Robinet à Encastrer



0753.0305



0752.0603

2219.0103	1/2	<b>14,00 €</b>	Cr
2219.0104	3/4	<b>15,00 €</b>	Cr

2220



### Castelo Completo

Llave Paso Completa  
Concealed Complete Tap  
Robinet à Encastrer



0753.0305



0752.0603

2220.0103	1/2	<b>12,00 €</b>	Cr
2220.0104	3/4	<b>12,50 €</b>	Cr

2401



## Misturadora Banheira

Grupo Baño/Ducha  
Double handle Bathtub Mixer  
Melangeur Bain/Douche

2401.0100 **55,00 €** Cr

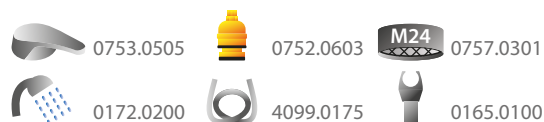

2402



## Misturadora Chuveiro

Grupo Ducha  
Double Handle Shower Mixer  
Melangeur Douche

2402.0100 **44,00 €** Cr

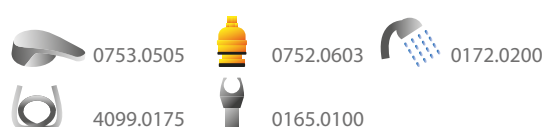

2403



## Monobloco Lavatório

Monobloc Lavabo  
Double Handle Basin Mixer  
Melangeur Lavabo

2403.0100 **44,00 €** Cr

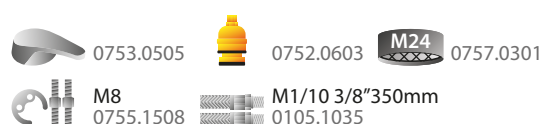

2404



## Monobloco Bidé

Monobloc Bidé  
Double Handle Bidet Mixer  
Melangeur Bidet

2404.0100 **44,00 €** Cr

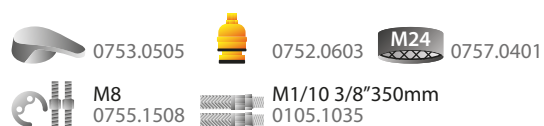

2405



## Monobloco Balcão

Monobloc Fregadero  
Double Handle Kitchen Mixer  
Melangeur Évier

2405.0100 **48,00 €** Cr

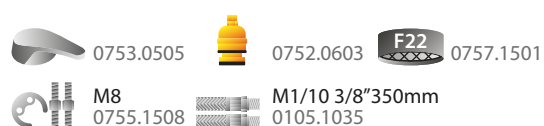



2408



**Misturadora Banca**  
Bateria Fregadero  
Double Handle Wall Sink Mixer  
Melangeur Cuisine Mural

2408.0100 **44,00 €** Cr



0753.0505



0752.0603



0757.1501

2410



**Torneira Lavatório**  
Grifo Lavabo  
Basin Tap  
Robinet Lavabo

2410.0100 **17,00 €** Cr



0753.0505



0752.0603



0757.1501

2411



**Torneira Banca**  
Grifo Mural  
Wall Mounted Tap  
Robinet Mural

2411.0103 1/2 **17,00 €** Cr

2411.0104 3/4 **19,00 €** Cr



0753.0505



0752.0603

2412



**Torneira Giratória Balcão**  
Grifo Giratorio Vertical  
High Swivel Spout Tap  
Robinet Bec Tournant

2412.0100 **24,00 €** Cr



0753.0505



0752.0603



0757.1501

2413



**Torneira Giratória Parede**  
Grifo Giratorio Mural  
Wall Swivel Spout Tap  
Robinet Bec Tournant Mural

2413.0100 **20,00 €** Cr



0753.0505



0752.0603



0757.1501

2414



### Torneira Esquadria

Llave Escuadra  
Angle Tap  
Robinet Angle



0753.0505



0752.0603

2414.0102	1/2 x 3/8	<b>15,00 €</b>	Cr
2414.0103	1/2 x 1/2	<b>16,00 €</b>	Cr
2414.0104	1/2 x 3/4	<b>16,00 €</b>	Cr

2415



### Torneira Máquina Lavar

Grifo Lavadora  
Washing Machine Tap  
Robinet p/ Machine à Laver



0753.0505



0752.0603

2415.0100		<b>16,00 €</b>	Cr
-----------	--	----------------	----

2416



### Torneira Dupla R/R

Grifo Doble R/R  
Double Tap R/R  
Robinet Double R/R



0753.0505



0752.0603

2416.0100		<b>30,00 €</b>	Cr
-----------	--	----------------	----

2417



### Torneira Dupla R/B

Grifo Doble R/B  
Double Tap R/B  
Robinet Double R/B



0753.0505



0752.0603

2417.0100		<b>30,00 €</b>	Cr
-----------	--	----------------	----

2419



### Torneira Passagem

Cabezal Llave de Paso  
Concealed Head Tap  
Tête de Robinet à Encastrer



0753.0505



0752.0603

2419.0103	1/2	<b>15,00 €</b>	Cr
2419.0104	3/4	<b>17,00 €</b>	Cr

2420



### Castelo Completo

Llave Paso Completa  
Concealed Complete Tap  
Robinet à Encastrer



0753.0505



0752.0603

2420.0103	1/2	<b>13,00 €</b>	Cr
2420.0104	3/4	<b>15,00 €</b>	Cr

3001



## Misturadora Banheira

Grupo Baño/Ducha  
Double handle Bathtub Mixer  
Melangeur Bain/Douche

3001.0100 **50,00 €** Cr

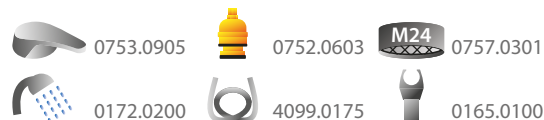

3002



## Misturadora Chuveiro

Grupo Ducha  
Double Handle Shower Mixer  
Melangeur Douche

3002.0100 **40,00 €** Cr

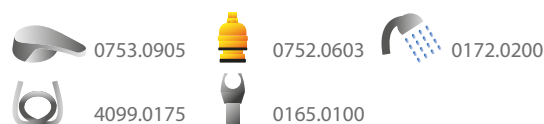

3003



## Monobloco Lavatório

Monobloc Lavabo  
Double Handle Basin Mixer  
Melangeur Lavabo

3003.0100 **40,00 €** Cr

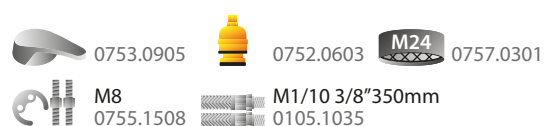

3004



## Monobloco Bidé

Monobloc Bidé  
Double Handle Bidet Mixer  
Melangeur Bidet

3004.0100 **40,00 €** Cr

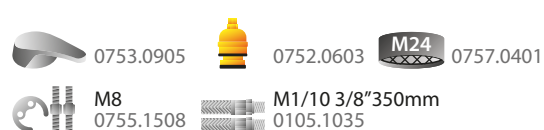

3005



## Monobloco Balcão

Monobloc Fregadero  
Double Handle Kitchen Mixer  
Melangeur Évier

3005.0100 **40,00 €** Cr

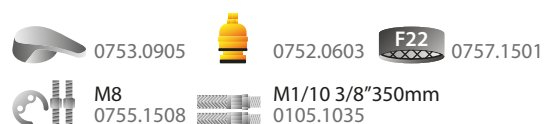

3008



**Misturadora Banca**  
Bateria Fregadero  
Double Handle Wall Sink Mixer  
Melangeur Cuisine Mural

3008.0100 **35,00 €** Cr



0753.0905 0752.0603 0757.1501

3010



**Torneira Lavatório**  
Grifo Lavabo  
Basin Tap  
Robinet Lavabo

3010.0100 **16,00 €** Cr

0753.0905 0752.0603 0757.1501

3011



**Torneira Banca**  
Grifo Mural  
Wall Mounted Tap  
Robinet Mural

3011.0103	1/2	<b>15,00 €</b>	Cr
3011.0104	3/4	<b>18,00 €</b>	Cr

0753.0905 0752.0603

3012



**Torneira Giratória Balcão**  
Grifo Giratorio Vertical  
High Swivel Spout Tap  
Robinet Bec Tournant

3012.0100 **20,00 €** Cr



0753.0905 0752.0603 0757.1501

3013



**Torneira Giratória Parede**  
Grifo Giratorio Mural  
Wall Swivel Spout Tap  
Robinet Bec Tournant Mural

3013.0100 **22,00 €** Cr



0753.0905 0752.0603 0757.1501



3014



### Torneira Esquadria

Llave Escuadra

Angle Tap

Robinet Angle



0753.0905



0752.0603

3014.0102	1/2 x 3/8	<b>14,00 €</b>	Cr
3014.0103	1/2 x 1/2	<b>14,00 €</b>	Cr
3014.0104	1/2 x 3/4	<b>14,00 €</b>	Cr

3015



### Torneira Máquina Lavar

Grifo Lavadora

Washing Machine Tap

Robinet p/ Machine à Laver



0753.0905



0752.0603

3015.0100		<b>15,00 €</b>	Cr
-----------	--	----------------	----

3016



### Torneira Dupla R/R

Grifo Doble R/R

Double Tap R/R

Robinet Double R/R



0753.0905



0752.0603

3016.0100		<b>25,00 €</b>	Cr
-----------	--	----------------	----

3017



### Torneira Dupla R/B

Grifo Doble R/B

Double Tap R/B

Robinet Double R/B



0753.0905



0752.0603

3017.0100		<b>25,00 €</b>	Cr
-----------	--	----------------	----

3019



### Torneira Passagem

Cabezal Llave de Paso

Concealed Head Tap

Tête de Robinet à Encastrer



0753.0905



0752.0603

3019.0103	1/2	<b>12,00 €</b>	Cr
3019.0104	3/4	<b>13,00 €</b>	Cr

3020



### Castelo Completo

Llave Paso Completa

Concealed Complete Tap

Robinet à Encastrer



0753.0905



0752.0603

3020.0103	1/2	<b>10,00 €</b>	Cr
3020.0104	3/4	<b>11,00 €</b>	Cr

# Componentes

Repuestos | Parts | Compléments



**757PM**  
Prelator M24  
Aireador M24  
Aerador M24  
Aérateur M24

Ref.	€/Un.	
0757.0301	1,30 €	10



**757PN**  
Prelator p/ Banheira M28  
Aireador M28  
Aerador M28  
Aérateur M28

Ref.	€/Un.	
0757.0001	1,40 €	10



**757PA**  
Prelator Antivandálico M24  
Aireador antivandálica M24  
Aerador Antivandalic M24  
Aérateur Anti Vandale M24

Ref.	€/Un.	
0757.0315	2,00 €	10



**757PP**  
Prelator M16,5 x 1  
Aireador M16'5 x 1  
Aerador M16,5 x 1  
Aérateur M16'5 x 1

Ref.	€/Un.	
0757.0340	4,58 €	5



**757PK**  
Prelator M22,5 x 1  
Aireador M22,5 x 1  
Aerador M22,5 x 1  
Aérateur M22,5 x 1

Ref.	€/Un.	
0757.0342	4,86 €	5



**757PB**  
Prelator Bica F22  
Aireador F22  
Aerador F22  
Aérateur F22

Ref.	€/Un.	
0757.1501	1,30 €	10



**757PA**  
Prelator Balcão Aqua  
Aireador Aqua  
Aerador Aqua  
Aérateur Aqua

Ref.	€/Un.	
0757.1509	1,50 €	5



**757PR**  
Prelator Rótula M24  
Aireador c/Rótula M24  
Ball Joint Aerador M24  
Rotulle a/Aérateur M24

Ref.	€/Un.	
0757.0401	4,50 €	5



**766QJ**  
Quebra-Jato p/ Torneira  
Rompe Chorros  
Breaking Jet  
Jet Rupture

Ref.	€/Un.	
0766.0101	0,33 €	10



**765DA**  
Distribuidor  
Inversor  
Diverter  
Inverseur

Ref.	€/Un.	
0765.0201	3,00 €	10



**765DN**  
Distribuidor Novo  
Inversor Novo  
Diverter Novo  
Inverseur Novo

Ref.	€/Un.	
0765.0301	3,70 €	10



**765DP**  
Distribuidor Prado  
Inversor Prado  
Diverter Prado  
Inverseur Prado

Ref.	€/Un.	
0765.0501	3,50 €	10



**766EC**  
Espigão p/ Corrente  
Porta Cadenas  
Chain Holder  
Support de Chaîne

Ref.	€/Un.	
0766.1001	0,20 €	1

# Componentes

Repuestos | Parts | Compléments



**764BA**  
Bica p/ Monocomando  
Caño p/ Monomando  
Spout f/ Mixer  
Bec p/ Mitigeur



Ref.		€/Un.	
0764.0190	Balcão - M	13,00 €	1
0764.0200	Banca B/S - F/H	15,00 €	1



**764BU**  
Bica p/ Monobloco Universal  
Caño p/ Monobloc Universal  
Universal Gooseneck  
Bec Col de Cygne Universel



Ref.		€/Un.	
0764.0210	Universal	15,00 €	1



**764BB**  
Bica p/ Monobloco Balcão  
Caño p/ Monobloc  
Gooseneck  
Bec Col de Cygne



Ref.		€/Un.	
0764.0201	Normal	8,80 €	1



**764BI**  
Bica p/ Monocomando B/I  
Caño p/ Monomando C/I  
Underneath Spout  
Bec-Dessous p/ Mitigeur



Ref.		€/Un.	
0764.0100	20 cm	8,00 €	1
0764.0251	33 cm	10,00 €	1



**764BS**  
Bica p/ Monocomando B/I tipo S  
Caño p/ Monomando C/I Tipo S  
Underneath Spout S-Type  
Bec-Dessous p/ Mitigeur S



Ref.		€/Un.	
0764.0241	20 cm	13,00 €	1



**764BM**  
Bica p/ Misturadora Banca  
Caño p/ Monobloc Mural  
Above Spout Nozzle  
Bec Sur Robinet



Ref.		€/Un.	
0764.0101	20 cm	8,00 €	1
0764.0104	25 cm	13,60 €	1



**764BMU**  
Bica p/ Misturadora Banca Universal  
Caño p/ Monobloc Universal  
Universal Above Spout  
Bec Sur Robinet Universel



Ref.		€/Un.	
0764.0110	20 cm	14,00 €	1
0764.0115	30 cm	16,00 €	1
0764.0107	40 cm	19,00 €	1



**764BMS**  
Bica Mist. Banca c/ Curva Universal  
Caño p/ Monobloc Mural "S"  
Underneath Spout "S"  
Bec-Dessous Robinet "S"



Ref.		€/Un.	
0764.0111	Universal	14,00 €	1



**764BF**  
Bica p/ Torneira Pedal  
Caño p/ Grifo Pedal  
Spout f/ Foot Tap  
Bec p/ Robinet à Pédale



Ref.	€/Un.	
0764.0501	24,00 €	1



**764BM**  
Bica Movel Coluna  
Caño Giratorio  
Swivel Spout  
Bec Pivotant



Ref.	€/Un.	
0211.1803	19,00 €	1

# Componentes

Repuestos | Parts | Compléments



**753MM**  
Manipulo Monocomando  
Maneta Monomando  
Handle f/ Mixer  
Levier p/ Mitigeur

Cr

Ref.		€/Un.	
0753.6048	Kubo		
0753.6041	Point	15,50 €	
0753.6044	Planus	7,00 €	
0753.6047	Kuadra	7,00 €	
0753.6043	New Astro	7,00 €	
0753.6045	Aqua	7,00 €	
0753.6010	Prado	6,00 €	
0753.6051	Cone	7,00 €	
0753.6052	Soft	7,00 €	
0753.6053	Plain	7,00 €	



**753ME**  
Manipulo Eco  
Mando Eco  
Eco Handle  
Poignée Eco

Cr

Ref.	€/Un.	
0753.0505	5,00 €	10



**753MT**  
Manipulo Tricórnio  
Mando Tricórnio  
Tricórnio Handle  
Poignée Tricórnio

Cr

Ref.	€/Un.	
0753.0905	3,75 €	10



**753EP**  
Manipulo Época  
Mando Época  
Época Handle  
Poignée Época

Cr

Ref.	€/Un.	
0753.0305	6,25 €	10



**753HC**  
Manipulo Hospitalar Comprido  
Maneta Medical Comprido  
Long Medical Lever  
Medical Levier Longue

Cr

Ref.	€/Un.	
0753.9906	22,00 €	Ø40



**753HP**  
Manipulo Hospitalar Curto  
Maneta Medical Cort  
Short Medical Lever  
Medical Levier Court

Cr

Ref.	€/Un.	
0753.9902	10,00 €	Castelo



**756CM**  
Campanula Monocomando  
Florón Cartucho  
Rosette f/ Cartridge  
Rosace p/ Cartouche

Cr

Ref.	€/Un.	
0756.0301	0,75 €	Ø35
0756.0401	0,80 €	Ø40



**753MP**  
Manipulo Popular  
Mando Popular  
Popular Handle  
Poignée Popular

Ref.		€/Un.	
0753.1104	Europeus	2,25 €	10
0753.1103	Antigo	2,25 €	10



**754DB**  
Disticos Monobloco  
Indicador Monobloc  
Double Handle Indicator  
Indicateur p/ Melauqeur

Cr

Ref.		€/Un.	
0754.0400	Época	0,16 €	100
0754.1100	Pop./Tric.	3,50 €	100
0755.0200	Eco	0,44 €	100



**761PN**  
Parafuso  
Tornillo  
Screw  
Vis

Ref.		€/Un.	
0761.0100	M4x8,5	7,80 €	100
0761.0101	3/16x8,5	5,50 €	100
0761.0102	M4x8	5,50 €	100



**754DM**  
Distico Monocomando  
Indicador  
Indicator  
Indicateur

Ref.	€/Un.	
0754.3220	0,10 €	100



**761PU** M5 x 6  
Parafuso Umbrako  
Tornillo Umbrako  
Umbrako Screw  
Vis Umbrako

Ref.	€/Un.	
0761.0200	0,08 €	100



# Componentes

Repuestos | Parts | Compléments



**752CB**  
Cartucho Cerâmico Baixo  
Cartucho Monocomando Raso  
Flat Cartridge  
Cartouche Plat



Ref.		€/Un.	
0752.0907	Ø25	5,00 €	5
0752.0905	Ø35	5,00 €	5
0752.0906	Ø40	6,00 €	5



**752CA**  
Cartucho Cerâmico Alto  
Cartucho Monocomando Alto  
High Cartridge  
Cartouche Élevé



Ref.		€/Un.	
0752.0903	Ø25	5,00 €	5
0752.0900	Ø35	5,00 €	5
0752.0901	Ø40	6,00 €	5



**752CJ**  
Cartucho Joystick  
Cartucho Joystick  
Joystick Cartridge  
Cartouche Joystick



Ref.		€/Un.	
0752.0915	Ø40	10,00 €	1

0211.0219



**752CG**  
Cartucho 25  
Cartucho 25  
Cartridge 25  
Cartouche 25



Ref.	€/Un.	
0752.0898	4,00 €	10

1869.0100



**752CD**  
Cartucho 25  
Cartucho 25  
Cartridge 25  
Cartouche 25



Ref.	€/Un.	
0752.0899	4,00 €	10

1870.1000 | 1870.1100



**752CE**  
Cartucho Eco  
Cartucho Eco  
Eco Cartridge  
Cartouche Eco



Ref.		€/Un.	
0752.0908	Ø35	6,00 €	5
0752.0909	Ø40	7,00 €	5



# Componentes

Repuestos | Parts | Compléments



**212CI**  
Cartucho Temporizado IDRAL  
Cartucho Temporizador IDRAL  
Self-Closing Cartridge IDRAL  
Cartouche Temporisé IDRAL

Ref.		€/Un.	
0212.1902	08140/E	25,00 €	1
0212.1903	08210/12	30,11 €	1
0212.1906	08000/E	25,20 €	1
0212.1905	8132	19,00 €	1



**208CP**  
Cartucho Temporizado Presto  
Cartucho Temporizador  
Self-Closing Cartridge  
Cartouche Temporisé

Ref.		€/Un.	
0208.0265	605	42,00 €	1
0208.0306	55/65	45,00 €	1
0208.0315	12A/27	51,50 €	1



**752CP**  
Cartucho Temporizado  
Cartucho Temporizador  
Self-Closing Cartridge  
Cartouche Temporisé

Ref.		€/Un.	
0752.0850	Aidia	10,75 €	5
0752.0860	PT	10,75 €	5



**752CT**  
Cartucho Termostático  
Cartucho Termostático  
Thermostatic Cartridge  
Cartouche Thermostatique

Ref.	€/Un.	
0752.0910	30,00 €	1



**752CF**  
Castelo Cerâmico  
Montura Cerâmica  
Caramic Head  
Tête Céramique



Ref.		€/Un.	
0752.0701		3,00 €	10
0752.0702		3,00 €	10



**752CU**  
Castelo Universal 1/2"  
Montura Universal  
Universal Check Head  
Tête Universel

Ref.		€/Un.	
0752.0603	1/2"	2,50 €	10
0752.0606	22x31 Novo	2,50 €	10
0752.0607	22x31 Ant.	2,50 €	10



# Componentes

Repuestos | Parts | Compléments



**755M6**  
Kit Fixação M6  
Kit Fijación M6  
Fixing Set M6  
Kit de Fixation M6

Ref.		€/Un.		
0755.1506	M6	1,50 €	10	50



**755M8**  
Kit Fixação M8  
Kit Fijación M8  
Fixing Set M8  
Kit de Fixation M8

Ref.		€/Un.		
0755.1508	M8	1,50 €	10	50
0755.1510	Retrãtril	2,00 €	5	50
0755.1512	12 cm	2,50 €	1	50



**760CE**  
Casquilho Excêntrico 3/4" x 1/2"  
Excêntrico 3/4" x 1/2"  
S-Connection 3/4" x 1/2"  
Raccord Excêntré 3/4" x 1/2"

Ref.		€/Un.		
0760.0100	Standard	1,80 €	10	50
0760.1000	Especial	7,50 €	10	50



**762EE**  
Espelho p/ Excêntrico  
Florón p/Excêntrico  
S-Connection Rosette  
Rosace p/ Excêntré

Ref.		€/Un.		
0762.0201	Especial	5,00 €	10	100



**762EP**  
Espelho p/ Passador  
Florón p/ Llave  
Rosette f/ Valve  
Rosace p/ Robinet

Ref.		€/Un.		
0762.0400	Inox	1,50 €	10	100
0762.0401	Cromo	1,50 €	10	100



**755AA**  
Argola Assentamento ABS  
Base ABS  
ABS Base  
Base ABS

Ref.		€/Un.		
0755.1000	Ø35	0,70 €	10	100
0755.1002	Ø40	0,80 €	10	100



**781VT**  
Vedação p/ Castelo  
Junta p/ Montura  
Washer f/ Check Head  
Joint p/ Tête

Ref.		€/Ct.		
0781.0102	1/2"	3,70 €	100	500
0781.0103	3/4"	4,50 €	100	500
0781.0104	1"	6,00 €	100	500



**786VF**  
Vedação c/ Filtro  
Junta c/ Filtro  
Joint w/ Filter  
Joint a/ Filtre

Ref.		€/Un.		
0786.0503	1/2"	0,63 €	100	500
0786.0504	3/4"	0,63 €	100	500



**758FA**  
Fêmea c/ Anilha  
Tuerca c/ Junta  
Nut w/ Joint  
Écrou a/ Joint

Ref.		€/Un.		
0758.1007	1/2"	0,17 €	10	100



**750CA**  
Caixa Alta Passador  
Caja Alta p/ Llave  
High Body f/ Valve  
Corp Clé Hant

Ref.		€/Un.		
0750.0201	1/2"	2,80 €	10	100
0750.0202	3/4"	3,80 €	10	100



**758FM**  
Fêmea Misturadora  
Tuerca  
Nut  
Écrou

Ref.		€/Un.		
0758.0101	3/4"	0,85 €	10	100



**763PP**  
Tubo p/ Passador  
Tubo p/ Llave  
Pipe f/ Valve  
Tube p/ Robinet

Ref.	€/Un.		
0763.0101	1,10 €	5	50



# ECOnomizadores de Água

Ahorro Agua | Saving Water | Économie D'Eau



757KE  
Kit Eco 5 peças  
Kit Eco 5 piezas  
Kit Eco 5 pieces  
Kit Eco 5 pièces



Ref. €/Un.

0757.0200 2,90 € 1



757KC  
Kit Eco Chuveiro 3 Redutores  
Kit Eco Ducha 3 Reductores  
Kit Eco Shower 3 Reducers  
Kit Eco Douche 3 Réducteurs



Ref. €/Un.

0757.0205 2,00 € 1



- 6 L/min.
- 8 L/min.
- 9 L/min.

757PF  
Prelator Flexível Economizador  
Aireador Flexible Eco  
Flexible Aerator Eco  
Brise Jet Eco

Ref. €/Un.

0757.0305 2,90 € 1



M24/F22



757PC  
Prelator rótula bica Eco  
Aireador Rótula Eco  
Ball Joint Aerator Eco  
Mousseur Eco



Ref. €/Un.

0757.1507 2,25 € 1

8 L/min. M24/F22



757EM  
Prelator Eco M24  
Aireador Eco M24  
Aerator M24 Eco  
Aérateur Eco M24

Ref. €/Un.

0757.0310 1,75 € 10

5 L/min



757EB  
Prelator Bica Eco  
Airador M22 Eco  
Aerator F22 Eco  
Aérateur F22 Eco

Ref. €/Un.

0757.1505 1,75 € 10

5 L/min



757EC  
Economizador Chuveiro  
Economizador Ducha  
Eco Shower Fitting  
Regulateur Débit

Ref. €/Un.

0757.1601 3,50 € 10

8 L/min  
M/F 1/2"  
M/H 1/2"





# Saunas de Infravermelhos, Resguardos, Colunas e Rampas de Chuveiro, Chuveiros de Mão, Chuveiros Fixos e Acessórios

Saunas de Infrarrojo, Mániparas, Columnas y Kits de Ducha, Duches de Mano, Duchas Fijas y Accesorios  
Infrared Saunas, Shower Enclosures, Shower Pannels and Sets, Hand Showers, Overhead Showers and Accessories  
Saunas Infrarouge, Paroi de Douche, Colonnes et Kits de Douche, Douchettes, Douches de Plafond et Accessoires



Ionizador lonizer Ionizador loniseur

## Elysium



Elysium Maximus 

4295.2003 **2.800,00 €**

 2150 W  x 2

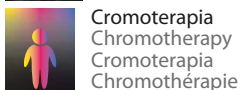
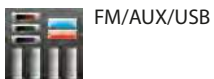

Elysium Magna 

4295.2002 **2.500,00 €**

 1800 W  x 2

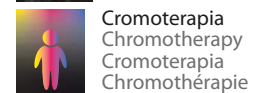

Elysium Prime 

4295.2001 **2.200,00 €**

 1400 W  x 1

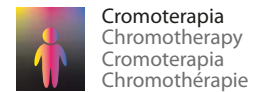

# Saunas de Infravermelhos

Saunas de Infrarrojo | Infrared Saunas | Saunas Infrarouge

O calor das saunas por infravermelhos penetra a um nível subcutâneo, sendo assim mais eficiente que uma sauna tradicional. A exposição ao calor controlado acelera o metabolismo e faz suar as toxinas e células malignas.

El calor de saunas de infrarrojos penetra a un nivel subcutáneo, de modo más eficiente que una sauna tradicional. La exposición al calor controlado acelera el metabolismo y hace sudar las toxinas y las células enfermas.

Infrared saunas heat penetrates the skin surface, thus being more efficient than a traditional sauna. Exposure to controlled heat accelerates the metabolism and sweats off toxins and unhealthy cells.

La chaleur du sauna infrarouge pénètre à un niveau sous-cutané, donc plus efficace qu'un sauna traditionnel. Exposition à la chaleur contrôlée accélère le métabolisme et fait suer les toxines et les cellules malignes.



## “Um privilégio de poucos, uma necessidade de todos!”

“Un privilegio de unos pocos, una necesidad de todos!”

“A privilege of a few, a need to everyone!”

“Un privilège de quelques-uns, un besoin pour tous!”

## Persus



Persus Maxi

4295.2103 **1.800,00 €**

2200 W x 2

FM/CD/MP3/  
AUX/USB/SD



Persus Medi

4295.2102 **1.600,00 €**

1820 W x 2

FM/CD/MP3/  
AUX/USB/SD



Persus Mini

4295.2101 **1.400,00 €**

1340 W x 1

FM/CD/MP3/  
AUX/USB/SD





# Resguardos

Mániparas | Shower Enclosures | Paroi de Douche

## Resguardo Chuveiro Class Shower Enclosure Class

## Mampara Ducha Class Paroi de Douche Class

Ref.		€/Un.
4353.0007	120 x 80	<b>385,00 €</b>

Perfil   
Perfil  
Profile  
Profil

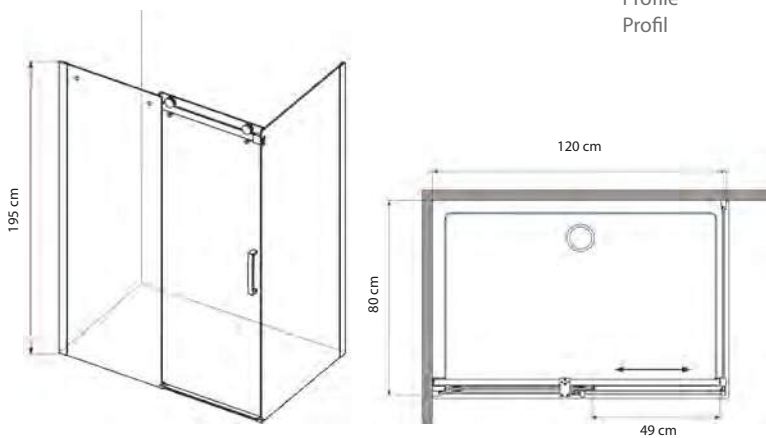

## Resguardo Chuveiro Angular c/ Base Mampara Ducha c/ Plato de Ducha Shower Enclosure w/ Shower Tray Paroi de Douche a/ Receveur de Douche

Ref.		€/Un.
4353.0103	80 x 80	<b>270,00 €</b>
4353.0104	90 x 90	<b>290,00 €</b>
4353.0105	100 x 80	<b>320,00 €</b>
4353.0107	120 x 80	<b>340,00 €</b>

### Sem Base Sin Plato de Ducha Without Shower Tray Sans Receveur de Douche

4353.0003	80 x 80	<b>210,00 €</b>
4353.0004	90 x 90	<b>230,00 €</b>

Perfil   
Perfil  
Profile  
Profil

Base acrílica  
Plato Ducha acrílico  
Acrylic Shower Tray  
Receveur de Douche Acrylique

Válvula Não Incluída  
Válvula No Incluída  
Valve Not Included  
Vanne Non Inclus



# Resguardos

Mániparas | Shower Enclosures | Paroi de Douche

Resguardo Chuveiro Circular c/ base    Mampara Ducha c/ plato de ducha  
Circular Shower w/ shower tray    Paroi de Douche a/ Receveur de Douche

Ref.		€/Un.
4353.0203	80 x 80	280,00 €
4353.0204	90 x 90	300,00 €

Perfil   
Perfil  
Profile  
Profil

Base acrílica  
Plato Ducha acrílico  
Acrylic Shower Tray  
Receveur de Douche Acrylique

Válvula Não Incluída  
Válvula No Incluída  
Valve Not Included  
Vanne Non Inclus

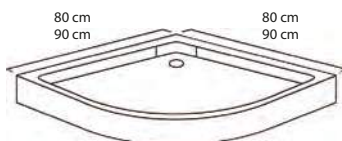
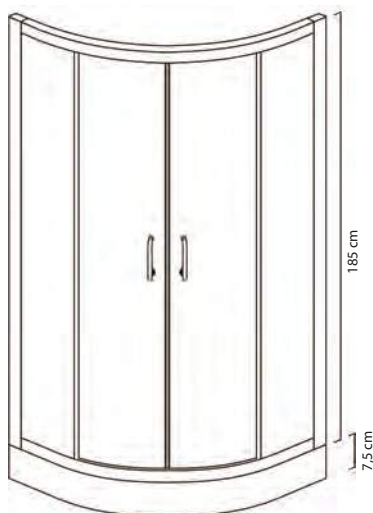

Portal Banheira  
Bath Screen

Portal Bañera  
Porte de Baignoire

Ref.		€/Un.
4353.0301	150 x 80	110,00 €

Perfil   
Perfil  
Profile  
Profil

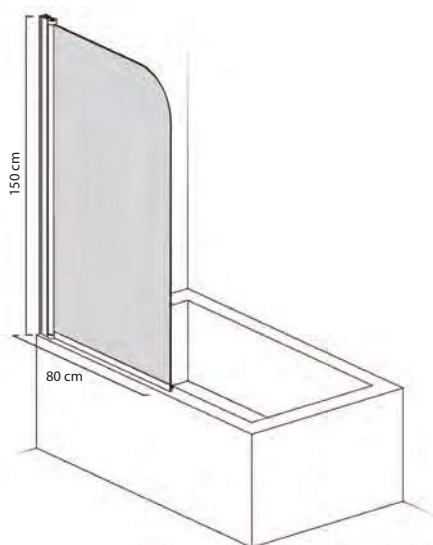



Coluna Argiro  
Columna Argiro  
Shower Pannel Argiro  
Colonne de Douche Argiro

Ref. €/Un.

4096.5109 370,00 €

4 Funções  
4 Funciones  
4 Functions  
4 Fonctions

S.S.

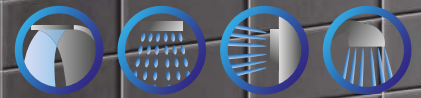

# Colunas Chuveiro

Columnas de Ducha | Shower Pannel | Colonnes de Douche



Quartzo



Onix

**4096SQ**  
Coluna Quartzo  
Columna Quartzo  
Shower Pannel Quartzo  
Colonne de Douche Quartzo

Ref. €/Un.

4096.5111 400,00 € 1



**4096SX**  
Coluna Chuveiro Onix  
Columna Onix  
Shower Pannel Onix  
Colonne de Douche Onix

Ref. €/Un.

4096.5107 400,00 € 1

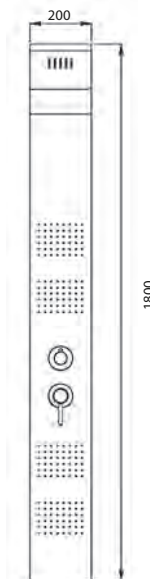

**4096SA**  
Coluna Chuveiro Argenta  
Columna Argenta  
Shower Pannel Argenta  
Colonne de Douche Argenta

Ref. €/Un.

4096.5105 350,00 € 1

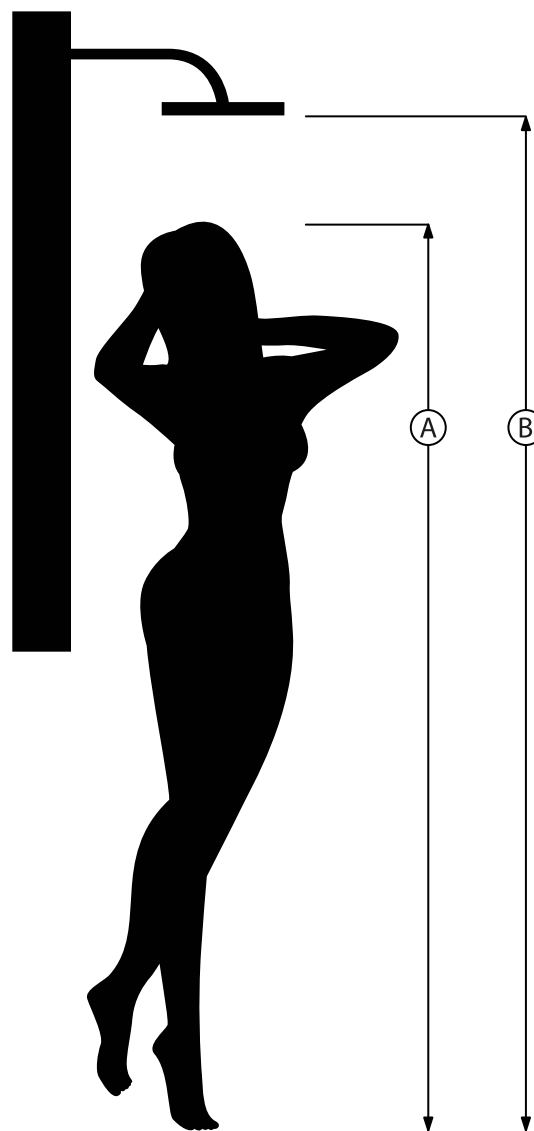
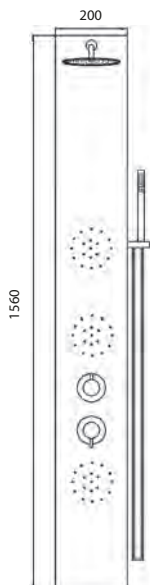

Altura recomendada p/ instalação  
Recommended heigth f/ installation

Altura recomendada p/ instalación  
Hauteur recommandée p/ l'installation

A (cm)	<165	170	175	180	185	190	195	200
B (cm)	185	190	195	200	205	210	215	220

# Rampas Telescópicas

Kit Ducha Telescópicas | Telescopic Shower Set | Kit Barre-Douche Téléscopique

## Fresh

**aidia**<sup>®</sup>



4096CF  
Rampa Telescópica Fresh  
Set de Ducha Telescópico Fresh  
Telescopic Shower Set Fresh  
Kit Barre-Douche Téléscopique Fresh

Ref.	€/Un.	Box
4096.4030	135,00 €	1

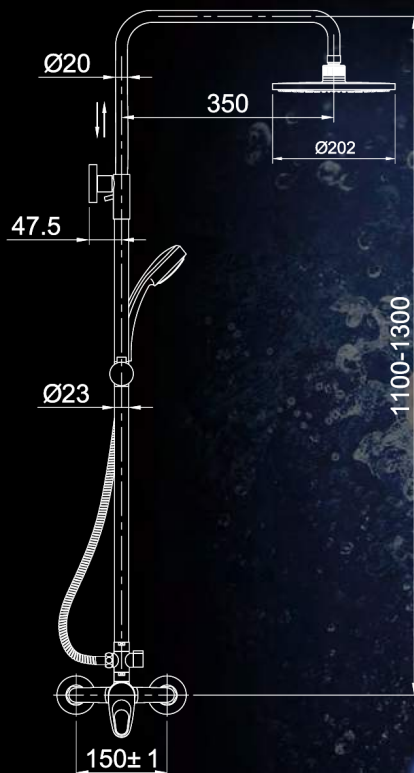

Inclui Monocomando  
Incluye Monocomando  
Includes Mixer  
Inclus Mitigeur



Caixa 9 Unidades  
Caja 9 Unidades  
Box 9 Units  
Boîte 9 Unités

4096.4035 1.100,00 € (1x9)

**aidia**<sup>®</sup>



4096RK  
Rampa Telescópica Prática  
Set de Ducha Telescópico Prática  
Telescopic Shower Set Prática  
Kit Barre-Douche Téléscopique Prática

Ref.	€/Un.	Box
4096.4005	220,00 €	6

Inclui Monocomando  
Incluye Monocomando  
Includes Mixer  
Inclus Mitigeur

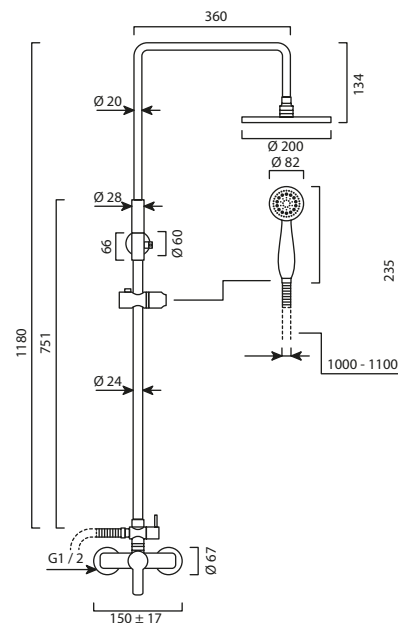
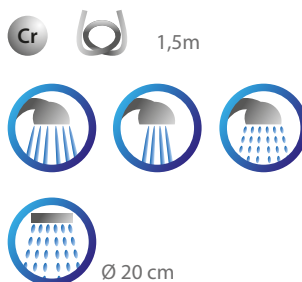

235



# Rampas Chuveiro

Kit Ducha | Shower Set | Kits de Douche



**4191RB**  
Rampa Chuveiro Basic  
Kit Ducha Basic  
Shower Set Basic  
Kit Barre-Douche Basic

Ref.	€/Un.	
4191.0180	15,00 €	1

Cr 1,75m



**Box Rampas Basic**  
Caixa 24 Unidades  
Caja 24 Unidades  
Box 24 units  
Boîte 24 Unités

Ref.	€/Un.
4191.0185	320,00 €



**4191RZ**  
Rampa Chuveiro Zen  
Kit Ducha Zen  
Shower Set Zen  
Kit Barre-Douche Zen

Ref.	€/Un.	
4191.0150	23,00 €	1

Cr 1,75m



**4191RM**  
Rampa Chuveiro New Silver  
Kit Ducha New Silver  
Shower Set New Silver  
Kit Barre-Douche New Silver

Ref.	€/Un.	
4191.0165	41,00 €	1

Cr 1,75m



**4191RS**  
Rampa Chuveiro Snake  
Kit Ducha Snake  
Shower Set Snake  
Kit Barre-Douche Snake

Ref.	€/Un.	
4191.0170	125,00 €	1

Br 1,5m



**4087RM**  
Rampa Muro  
Barra Muro  
Sliding Bar Muro  
Barre Coulissante Muro

Ref.	€/Un.	
4087.0102	17,50 €	1

Cr



# Chuveiros de Mão

Duches de Mano | Hand Showers | Douchettes



LED Rainbow

Ref. €/Un.

4197.0860 23,00 € 1



Cr



Hydro Silver

Ref. €/Un.

sem suporte / sin soporte / no holder / sans support

4197.0401 5,00 € 1

com suporte / con soporte / with holder / avec support

4197.0405 6,00 € 1



Nixie

Ref. €/Un.

4197.0320 5,50 € 1

Cr



O2

Ref. €/Un.

4197.0325 6,50 € 1

Cr



Lazio

Ref. €/Un.

4197.0855 8,00 € 1

Cr



Toscana

Ref. €/Un.

4197.0853 10,60 € 1

Cr



Veneto

Ref. €/Un.

4197.0851 3,00 € 1

Cr



Zen

Ref. €/Un.

4194.0501 5,80 € 1

Cr



Anello

Ref. €/Un.

4197.0820 10,00 € 1

Cr



Ovalle

Ref. €/Un.

4197.0825 10,00 € 1

Cr



# Chuveiros de Mão

Duches de Mano | Hand Showers | Douchettes



Lisboa

Ref.		€/Un.	
0172.0200	Cr	2,30 €	50
0172.0201	Br	1,90 €	50



Link

Ref.	€/Un.	
0176.0100	5,00 €	1



**AMFAG**



**Chuveiro Retrátil Luxo**  
Ducha Extraíble LUXO  
Pull-Out Spray LUXO  
Douchette p/ Mitigeur LUXO

Ref.	€/Un.	
0175.1101	12,00 €	1



**Chuveiro Retrátil**  
Ducha Extraíble  
Pull-Out Spray  
Douchette p/ Mitigeur

Ref.	€/Un.	
0175.0101	7,00 €	1



**Chuveiro Retrátil TDF**  
Ducha Extraíble TDF  
Pull-Out Spray TDF  
Douchette p/ Mitigeur TDF

Ref.	€/Un.	
0175.0140	10,00 €	1



**Chuveiro Misturadora Balcão**  
Ducha p/ Fregadero  
Shower f/ Mixer  
Mini Douchette p/ Mitigeur

Ref.	€/Un.	
0211.0605	7,50 €	1



**idral**

**Chuveiro Industrial**  
Ducha Industrial  
Industrial Shower  
Industriel Douchette

Ref.	€/Un.	
0212.1833	110,00 €	1



**Chuveiro Industrial**  
Ducha Industrial  
Industrial Shower  
Industriel Douchette

Ref.	€/Un.	
0211.0601	31,00 €	1



aidia®

Swash

Swash - Chuveiro c/ sistema de som  
Swash - Shower w/ sound system

Swash - Ducha c/ sistema de sonido  
Swash - Douche a/ système de son

Ref.  €/Un.   
4197.0870 Ø22 60,00 € 1





PC/Mac

Tablet

Smartphone



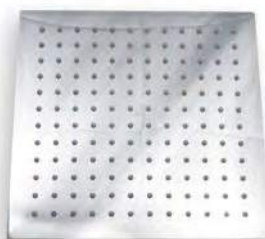

4198RI  
Chuveiro Redondo Inox  
Douche de Tête Rond  
S. S. Round Shower  
Ducha Redonda Inox

Ref.  €/Un.   
4198.0210 Ø20 48,00 € 1  
4198.0212 Ø25 58,00 € 1





4198KI  
Chuveiro Quadrado Inox  
Ducha Cuadrada Inox  
S. S. Square Shower  
Douche de Tête Carré Inox

Ref.  €/Un.   
4198.0200 20x20 48,00 € 1  
4198.0202 25x25 58,00 € 1





209CR  
Chuveiro ABS Redondo  
Ducha Redonda ABS  
ABS Rond Shower  
Douche de Tête Rond ABS

Ref.  €/Un.   
0209.1522 Ø20 23,00 € 1



155RC  
Ralo Chuveiro Latão  
Ducha Latón  
Brass Shower  
Douche de Tête Laiton

Ref.  €/Un.   
0155.0106 Ø6 4,00 € 1  
0155.0108 Ø8 4,50 € 1  
0155.0110 Ø10 5,00 € 1



156RC  
Ralo Chuveiro Cónico Latão  
Ducha Cónica Latón  
Brass Conic Shower  
Douche de Tête Conique Laiton

Ref.  €/Un.   
0156.0100 4,00 € 1



157RC  
Ralo Chuveiro c/ Rótula Latão  
Ducha c/ Rótula  
Ball Joint Shower  
Douche de Tête a/ Rotule

Ref.  €/Un.   
0157.0100 8,50 € 1



4197CS  
Chuveiro Fixo Simples  
Ducha Fija Simple  
Simple Shower  
Douche de Tête Simple

Ref.  €/Un.   
4197.0503 5,00 € 1



4197CF  
Chuveiro Fixo 3F  
Ducha 3F  
Shower 3F  
Douche de Tête 3F

Ref.  €/Un.   
4197.0504 6,50 € 1





# Kits chuveiro Higiénico

Kits Ducha Higiénica | Kits Hygienic Shower | Kits Douchette Hygiénique



Chuveiro Higiénico  
Ducha Higiénica  
Hygienic Shower  
Douchette Hygiénique

Ref.	€/Un.	
4198.0110	13,00 €	1



## Kit Mini:

Ref.	€/Un.	
4198.0352	25,00 €	1



Chuveiro Higiénico  
Ducha Higiénica  
Hygienic Shower  
Douchette Hygiénique



Ligação Chuveiro 1,5 m  
Flexo Ducha 1,5 m  
Flexible Hose 1,5 m  
Flexible de Douche 1,5 m



Suporte Latão  
Soporte Latón  
Brass Support  
Support Laiton

## Kit Medio:

Ref.	€/Un.	
4198.0355	30,00 €	1



Chuveiro Higiénico  
Ducha Higiénica  
Hygienic Shower  
Douchette Hygiénique



Ligação Chuveiro 1,5 m  
Flexo Ducha 1,5 m  
Flexible Hose 1,5 m  
Flexible de Douche 1,5 m



Suporte Encastar c/Stop Latão  
Soporte Mural c/Stop Latón  
Brass Wall Shower Holder w/Stop  
Support Mural a/stop Laiton

## Kit Maxi:

Ref.	€/Un.	
4198.0350	35,00 €	1



Chuveiro Higiénico  
Ducha Higiénica  
Hygienic Shower  
Douchette Hygiénique



Ligação Chuveiro 1,5 m  
Flexo Ducha 1,5 m  
Flexible Hose 1,5 m  
Flexible de Douche 1,5 m



torneira c/Suporte  
Válvula c/Suporte  
Valve w/Support  
Robinet a/ Support

## Kit Deluxe:

Ref.	€/Un.	
4198.0357	40,00 €	1



Chuveiro Higiénico  
Ducha Higiénica  
Hygienic Shower  
Douchette Hygiénique



Ligação Chuveiro 1,5 m  
Flexo Ducha 1,5 m  
Flexible Hose 1,5 m  
Flexible de Douche 1,5 m

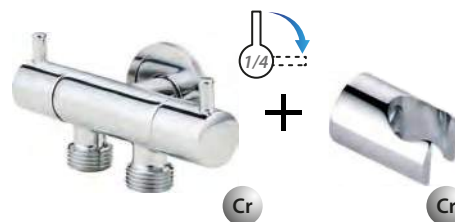

Torneira Dupla 1/2"  
Válvula Doble 1/2"  
Double Angle Valve 1/2"  
Robinet Double 1/2"

Suporte Latão  
Soporte Latón  
Brass Support  
Support Laiton



# Chuveiros Fixos e Acessórios

Duchas Fijas y Accesorios | Overhead Showers and Accessories | Douches de Plafond et Accessoires



**4197CH**  
Kit Chuveiro c/Haste  
Kit Ducha c/Braço  
Shower w/Arm Kit  
Kit Douche de Tête w/Support

Ref.	€/Un.	Box
4197.0305	10,00 €	1



**158HC**  
Haste Mural  
Braço Parede  
Wall Bar  
Support Mural



Ref.	30cm	€/Un.	Box
0158.0130	30cm	5,30 €	1
0158.0140	40cm	6,00 €	1
0158.0150	50cm	6,80 €	1



**209HC**  
Haste Mural Cilíndrica  
Braço Parede Cilíndrico  
Cilindrical Wall Bar  
Support Mural Cylindrique



Ref.	35cm	€/Un.	Box
0209.1508	35cm	35,00 €	1



**209HQ**  
Cilíndrico Haste Mural Quadrada  
Braço Mural Cuadrado  
Support Wall Bar  
Support Mural Carré



Ref.	35cm	€/Un.	Box
0209.1502	35cm	40,00 €	1



**158TR**  
Haste Teto Cilíndrica  
Braço Techo Cilíndrico  
Cilindrical Ceiling Bar  
Support Toit Cylindrique



Ref.	20cm	€/Un.	Box
0158.0405	20cm	35,43 €	1



**158TQ**  
Haste Teto Quadrada  
Braço Techo Cuadrado  
Square Ceiling Bar  
Support Toit Carré



Ref.	20cm	€/Un.	Box
0158.0400	20cm	42,58 €	1



**4198SS**  
Suporte Encastrar c/ Stop  
Soporte Mural c/ Stop  
Wall Shower Holder w/ Stop  
Support Mural a/ Stop



Ref.	1/2	€/Un.	Box
4198.0360	1/2	13,00 €	1



**209TE**  
Tomada Encastrar p/ Ligação  
Toma Mural p/ Flexo  
Wall Adapter f/ Hose  
Coude Mural p/ Flexible



Ref.	1/2x1/2	€/Un.	Box
0209.1505	1/2x1/2	5,14 €	1



**4198TQ**  
Tomada Encastrar Quadrada  
Toma Mural Cuadrada  
Square Wall Shower Holder  
Support Mural p/ Flexible Carré



Ref.	1/2	€/Un.	Box
4198.0215	1/2	39,00 €	1



**4198TR**  
Tomada Encastrar Cilíndrica  
Toma Mural Cilíndrico  
Cylindrical Shower Holder  
Support Mural p/ Flexible Cylindrique



Ref.	1/2x1/2	€/Un.	Box
4198.0217	1/2x1/2	33,00 €	1

# Suportes e Ligações de Chuveiros

Soportes y Flexos de ducha | Shower Supports and Flexible Hoses | Supports et Flexibles de Douche



**165SV**  
**Suporte Chuveiro c/ Ventosa**  
 Soporte Duche c/ Ventosa  
 Shower Support w/ Sucker  
 Support de Douche a/ Ventouse

**Ref.** €/Un.

0165.0500 5,65 € 1



**167SL**  
**Suporte Chuveiro Link**  
 Shower Support Link  
 Soporte Ducha Link  
 Support de Douche Link

**Ref.** €/Un.

0167.0500 5,30 € 1



**165CL**  
**Suporte Chuveiro Luxo**  
 Soporte Ducha Luxo  
 Shower Support Luxo  
 Support de Douche Luxo

**Ref.** €/Un.

0165.0100 4,15 € 1



**163SS**  
**Suporte Chuveiro Standard**  
 Soporte Ducha Standard  
 Shower Support Standard  
 Support de Douche Standard

**Ref.** €/Un.

0163.0250 2,25 € 1



**161SR**  
**Suporte Chuveiro Rótula**  
 Soporte Ducha Rótula  
 Ball Joint Shower Support  
 Support de Douche a/ Rotule

**Ref.** €/Un.

0161.0101 5,66 € 1



**160SC**  
**Suporte Chuveiro Simples**  
 Soporte Ducha Simple  
 Simple Shower Support  
 Support de Douche Simple

**Ref.** €/Un.

0160.0101 1,46 € 1



**110R**  
**Ligação Flexível Retrátil - 1/2"**  
 Flexo Ducha Extraíble - 1/2"  
 Pull-out Flexible Hose - 1/2"  
 Flexible de Douche p/ Mitiqueur - 1/2"

**Ref.** €/Un.

0110.3125 125 6,54 € 5

0110.3150 150 7,29 € 5



**4099**  
**Ligação Extensível Inox - 1/2"**  
 Flexo de Ducha Extensible - 1/2"  
 Extensible Flexible Hose - 1/2"  
 Flexible de Douche Extensible - 1/2"

**Ref.** €/Un.

4099.0175 1,70 x 2,25 3,80 € 5



**110G**  
**Ligação Flexível c/ Cone - 1/2"**  
 Flexo Ducha Rosca Cónico - 1/2"  
 Flexible Hose Conic Nut - 1/2"  
 Flexible de Douche Écrou Conique - 1/2"

**Ref.** €/Un.

0110.1125 125 6,22 € 5

0110.1150 150 6,73 € 5

0110.1175 175 7,46 € 5

0110.1200 200 8,33 € 5



**109**  
**Ligação Flexível - 1/2"**  
 Flexo Ducha - 1/2"  
 Flexible Hose - 1/2"  
 Flexible de Douche - 1/2"

**Ref.** €/Un.

0109.1125 125 5,61 € 5

0109.1150 150 6,17 € 5

0109.1175 175 6,95 € 5

0109.1200 200 8,14 € 5

# 1.2

Acessórios WC  
Accesórios WC | WC Accessories | Accessoires WC



## Acessórios Casa de Banho

Juegos Cuarto de Baño | Bathroom Sets | Jeux Salle de Bain

# Planus



86920 / 86924



Cr

Toalheiro Barra  
Toallero Barra  
Towel Bar  
Barre Porte Serviette

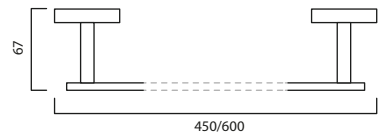

Ref.  €/Un.

4417.0101 45 cm **26,00 €**

4417.0102 60 cm **29,00 €**

86924D



Cr

Toalheiro Duplo  
Toallero Doble  
Double Towel Bar  
Barre Porte-Serviette Double

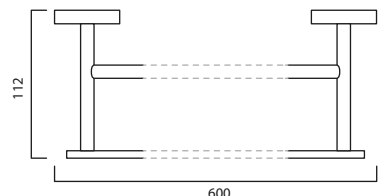

Ref.  €/Un.

4417.0104 **37,00 €**

86980



Cr

Toalheiro Bidé  
Toallero Bidé  
Bidet Towel Bar  
Porte Serviette Bidet

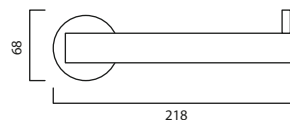

Ref.  €/Un.

4417.0105 **15,00 €**



86986



**Porta Rolos**  
Portarollos  
Paper Holder  
Porte-Roleaux

**Ref. €/Un.**



4417.0116 **15,00 €**

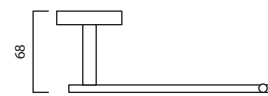
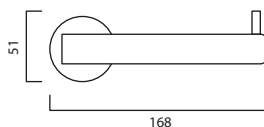

86985



**Saboneteira**  
Jabonera  
Soap Dish  
Porte Savon

**Ref. €/Un.**



4417.0125 **19,00 €**

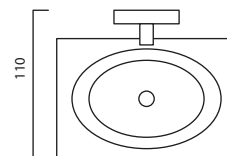
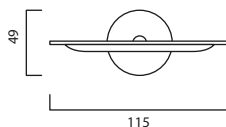

86988



**Porta-Piaçaba**  
Escobillero  
Toilet Brush  
Porte-Balayette

**Ref. €/Un.**



4417.0140 **33,00 €**

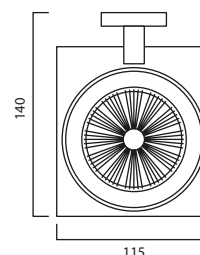
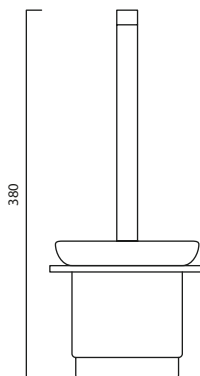

86982



**Cabide**  
Percha  
Hook  
Patère

**Ref. €/Un.**



4417.0135 **11,00 €**

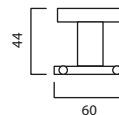

**Kit 6 Peças**  
Kit 6 Piezas  
Kit 6 Pieces  
Kit 6 Pieces

**Ref. €/Un.**

4417.0200 **115,00 €**



85620 / 86524 / 85680 / 85686 / 85685 / 85682



# Acessórios Casa de Banho

Juegos Cuarto de Baño | Bathroom Sets | Jeux Salle de Bain



## 83900



83930 / 83924



Cr

**Toalheiro Barra**  
Toallero Barra  
Towel Bar  
Barre Porte Serviette

**Ref.**  **€/Un.**

4414.0101 45 cm **17,00 €**

4414.0102 60 cm **19,00 €**

4414.0104 60 cm (x2) **33,00 €**

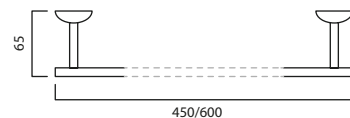
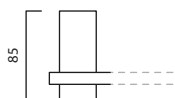

83924D



Cr

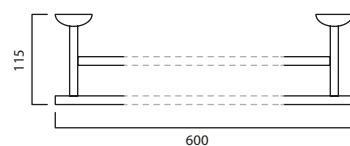

83962



Cr

**Porta Toalhas**  
Porte Toallas  
Towel Shelf  
Tablette Porte Serviette

**Ref.**  **€/Un.**

4414.0106 **47,00 €**

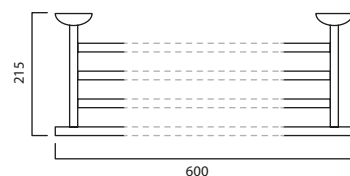
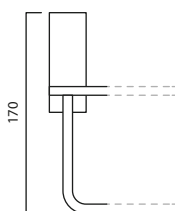

83980



Cr

**Toalheiro Bidé**  
Toallero Bidé  
Bidet Towel Bar  
Porte Serviette Bidet

**Ref.**  **€/Un.**

4414.0105 **14,00 €**

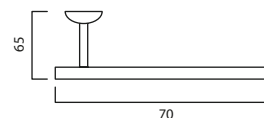
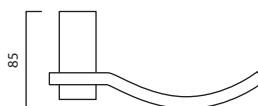

83984



Cr

**Porta Copos**  
Portevasos  
Glass Holder  
Porte-Gobelet

**Ref.**  **€/Un.**

4414.0110 **14,00 €**

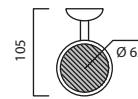
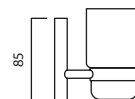
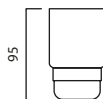



83986

**Porta Rolos**  
Portarollos  
Paper Holder  
Porte-Roleaux

Cr

**Ref. €/Un.**

4414.0115 **15,00 €**

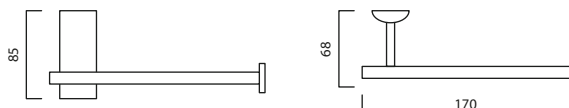

83911

**Esponjeira Rede**  
Jabonera Red  
Soap Basket  
Porte Savon Réseau

Cr

**Ref. €/Un.**

4414.0120 **23,10 €**

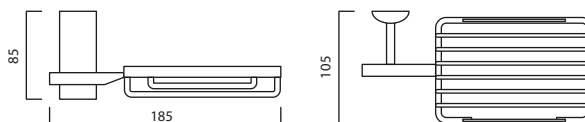

83985

**Saboneteira**  
Jabonera  
Soap Dish  
Porte Savon

Cr

**Ref. €/Un.**

4414.0125 **13,00 €**

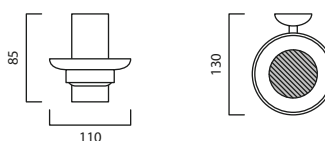

83911

**Porta-Piaçaba**  
Escobillero  
Toilet Brush  
Porte-Balayette

Cr

**Ref. €/Un.**

4414.0140 **46,00 €**

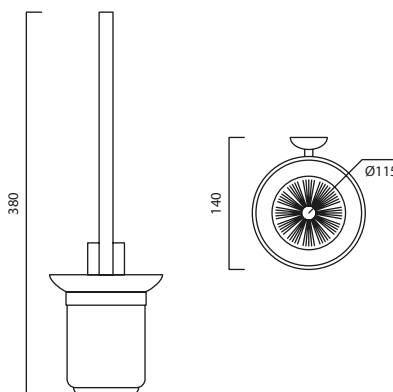

83985

**Cabide**  
Percha  
Hook  
Patère

Cr

**Ref. €/Un.**

4414.0135 **8,00 €**



**Kit 6 Peças**  
Kit 6 Piezas  
Kit 6 Pieces  
Kit 6 Pieces

**Ref. €/Un.**

4414.0200 **86,00 €**



83930 / 83924 / 83980 / 83986 / 83911 / 83985

## 86200



86220 / 86224



**Toalheiro Barra Inox**  
Toallero Barra Inox  
S. S. Towel Bar  
Barre Porte Serviette Inox

Ref.	Image	Length	€/Un.
4418.0101		45 cm	16,00 €
4418.0102		60 cm	17,00 €

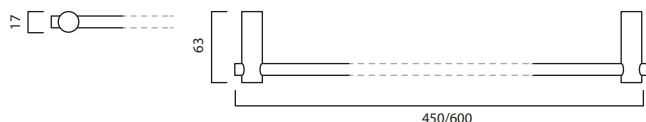

86224D



**Toalheiro Duplo Inox**  
Toallero Doble Inox  
S. S. Double Towel Bar  
Barre Porte-Serviette Double Inox

Ref. **€/Un.**

4418.0104 **28,00 €**

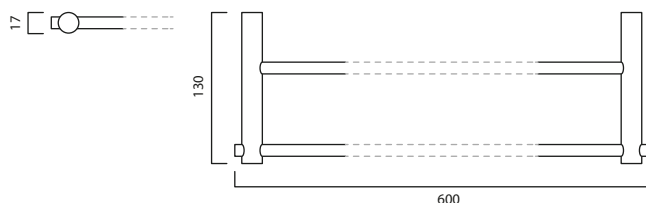

86262



**Porta Toalhas Inox**  
Porte Toallas Inox  
S. S. Towel Shelf  
Tablette Porte Serviette Inox

Ref. **€/Un.**

4418.0106 **60,00 €**

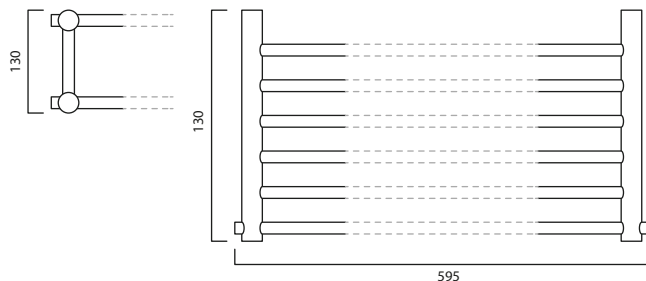

86280



**Toalheiro Bidé Inox**  
Toallero Bidé Inox  
S. S. Bidet Towel Bar  
Porte-Serviettes Bidet Inox

Ref. **€/Un.**

4418.0105 **14,00 €**

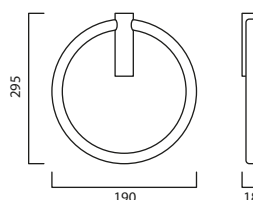



86286S



**Porta Rolos Inox**  
Portarollos Inox  
S. S. Paper Holder  
Porte-Roleaux Inox

**Ref. €/Un.**

4418.0115 **15,00 €**

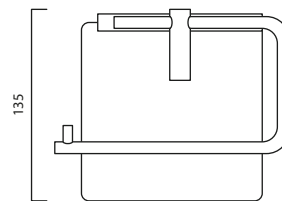
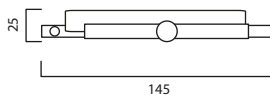

86286



**Porta Rolos Inox**  
Portarollos Inox  
S. S. Paper Holder  
Porte-Roleaux Inox

**Ref. €/Un.**

4418.0116 **15,00 €**

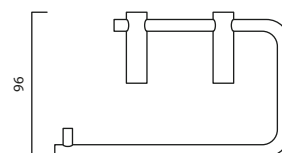
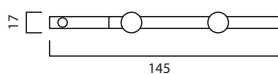

86211



**Saboneteira Inox**  
Jabonera Inox  
S. S. Soap Dish  
Porte Savon Inox

**Ref. €/Un.**

4418.0125 **22,00 €**

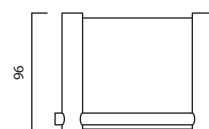
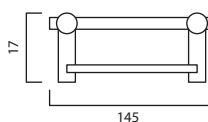

86288



**Porta-Piaçaba Inox**  
Escobillero Inox  
S. S. Toilet Brush  
Porte-Balayette Inox

**Ref. €/Un.**

4418.0140 **46,00 €**

86282



**Cabide Inox**  
Percha Inox  
S. S. Hook  
Patère Inox

**Ref. €/Un.**

4418.0135 **13,00 €**

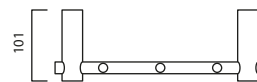
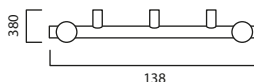

**Kit 6 Peças**  
Kit 6 Piezas  
Kit 6 Pieces  
Kit 6 Pieces

**Ref. €/Un.**

4418.0200 **97,00 €**



86220 / 86224 / 86280 / 86286S / 86211 / 86282



## 85600

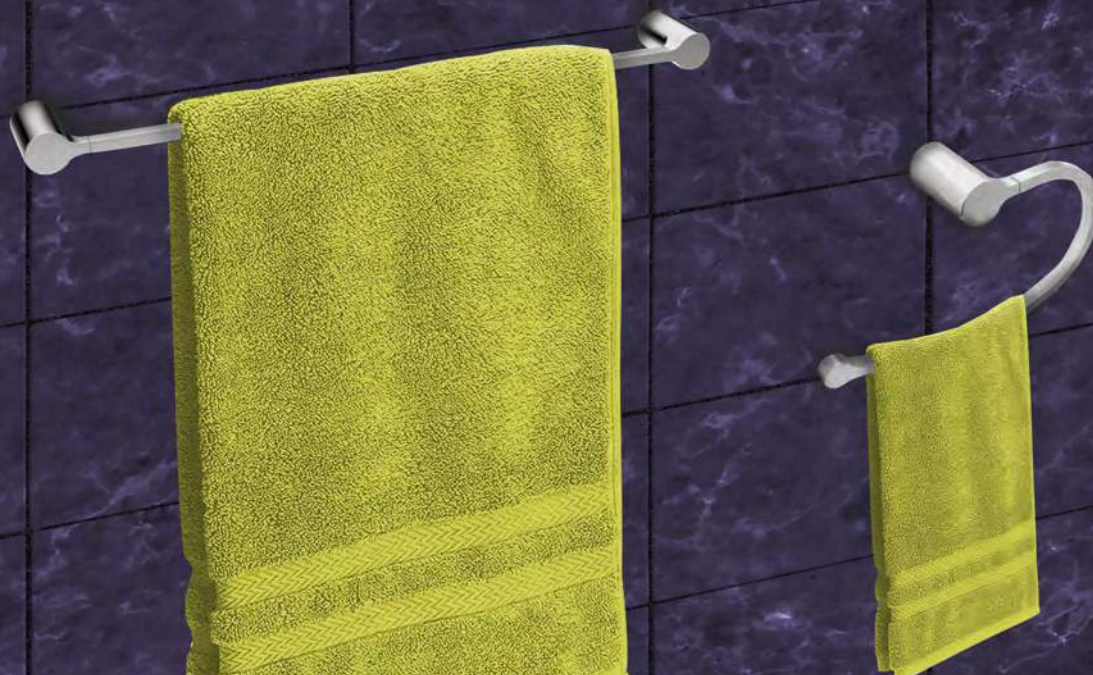

85620 / 85624



Cr

**Toalheiro Barra**  
Toallero Barra  
Towel Bar  
Barre Porte Serviette

Ref.		€/Un.
4419.0101	45 cm	26,00 €
4419.0102	60 cm	27,00 €

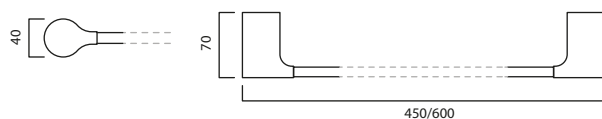

85680



Cr

**Toalheiro Bidé**  
Toallero Bidé  
Bidet Towel Bar  
Porte Serviette Bidet

Ref.	€/Un.
4419.0105	22,00 €

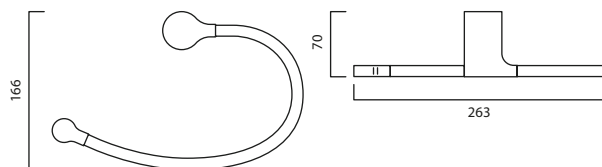

85684



Cr

**Porta Copos**  
Portavasos  
Glass Holder  
Porte-Gobelet

Ref.	€/Un.
4419.0110	16,00 €

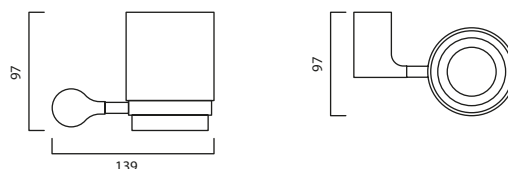

85686



**Porta Rolos**  
Portarollos  
Paper Holder  
Porte-Roleaux

**Ref. €/Un.**

4419.0115 **17,00 €**

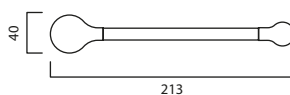

85611



**Esponjeira Rede**  
Jabonera Red  
Soap Basket  
Porte Savon Réseau

**Ref. €/Un.**

4419.0120 **22,00 €**

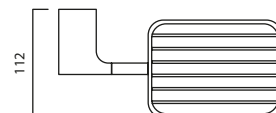
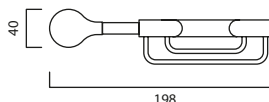

85685



**Saboneteira**  
Jabonera  
Soap Dish  
Porte Savon

**Ref. €/Un.**

4419.0125 **17,00 €**

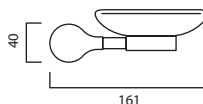

85688



**Porta-Piaçaba**  
Escobillero  
Toilet Brush  
Porte-Balayette

**Ref. €/Un.**

4419.0140 **27,00 €**

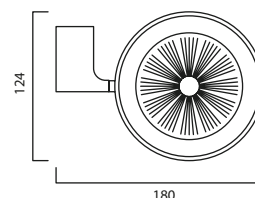
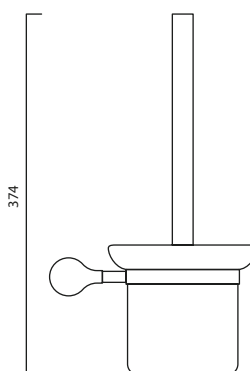

85682



**Cabide**  
Percha  
Hook  
Patère

**Ref. €/Un.**

4419.0135 **7,00 €**



**Kit 6 Peças**  
Kit 6 Piezas  
Kit 6 Pieces  
Kit 6 Pieces

**Ref. €/Un.**

4419.0200 **110,00 €**



85620 / 86524 / 85680 / 85686 / 85685 / 85682



## 87200



87220 / 87224



Cr

**Toalheiro Barra**  
Toallero Barra  
Towel Bar  
Barre Porte Serviette

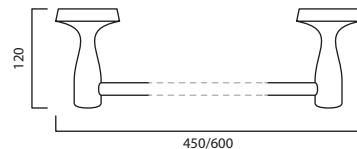
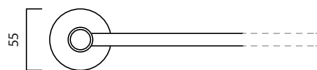

**Ref.** **€/Un.**

4420.0101 45 cm **15,00 €**

4420.0102 60 cm **16,00 €**

87262



Cr

**Porta Toalhas**  
Porte Toallas  
Towel Shelf  
Tablette Porte Serviette

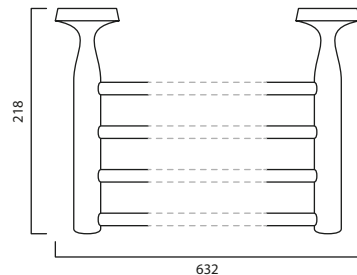
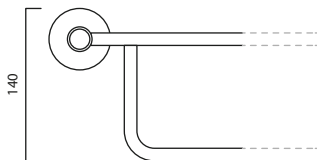

**Ref.** **€/Un.**

4420.0106 **45,00 €**

87280



Cr

**Toalheiro Bidé**  
Toallero Bidé  
Bidet Towel Bar  
Porte Serviette Bidet

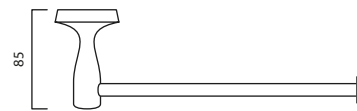

**Ref.** **€/Un.**

4420.0105 **13,00 €**

87284



Cr

**Porta Copos**  
Portevasos  
Glass Holder  
Porte-Gobelet

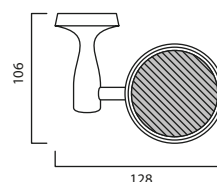
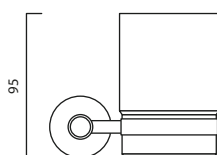

**Ref.** **€/Un.**

4420.0110 **13,00 €**

87286



Cr

**Porta Rolos**  
Portarollos  
Paper Holder  
Porte-Roleaux

**Ref. €/Un.**

4420.0115 **13,00 €**

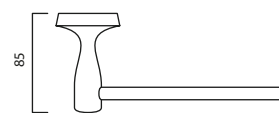
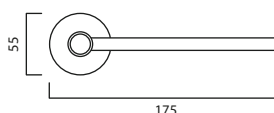

87211



Cr

**Esponjeira Rede**  
Jabonera Red  
Soap Basket  
Porte Savon Réseau

**Ref. €/Un.**

4420.0120 **20,00 €**

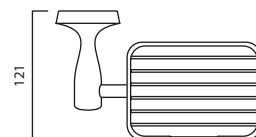
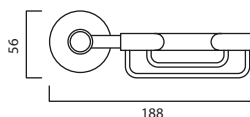

87285



Cr

**Saboneteira**  
Jabonera  
Soap Dish  
Porte Savon

**Ref. €/Un.**

4420.0125 **13,00 €**

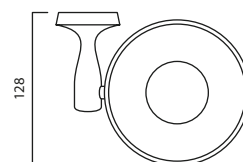
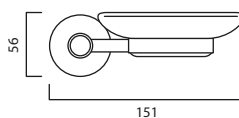

87288



Cr

**Porta-Piaçaba**  
Escobillero  
Toilet Brush  
Porte-Balayette

**Ref. €/Un.**

4420.0140 **23,00 €**

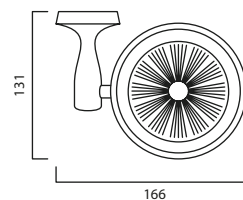
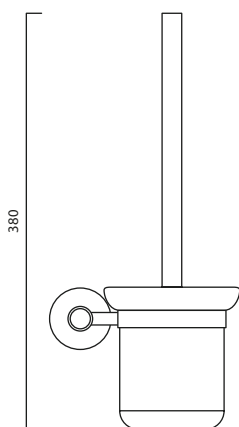

87282



Cr

**Cabide**  
Percha  
Hook  
Patère

**Ref. €/Un.**

4420.0135 **7,00 €**

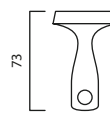
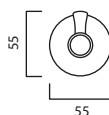

**Kit 5 Peças**  
Kit 5 Piezas  
Kit 5 Pieces  
Kit 5 Pieces

**Ref. €/Un.**

4420.0210 **57,00 €**



87220 / 87224 / 87280 / 87286 / 87282



# Barras de Apoio e Ajudas Técnicas em Inox

Barras y Ayudas Técnicas en Inox | Grab Bars and Mobility Technic Support in Inox | Barres d'Apui et Aides Techniques dans Inox



Mt **Inox** Ø 35 mm

## Barra Reta

Barra Recta  
Straight Bar  
Barre Droit

Ref.		€/Un.
0100.1010	35cm	<b>30,00 €</b>
0100.1020	45cm	<b>33,00 €</b>
0100.1030	60cm	<b>36,00 €</b>

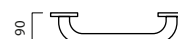
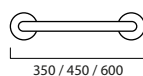

Mt **Inox** Ø 35 mm

## Barra Angular 135°

Barra Angular 135°  
Angle Bar 135°  
Barre D'Angle 135°



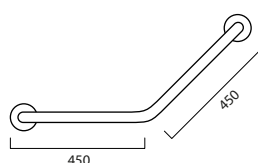

Ref.		€/Un.
0100.1110	45x45	<b>50,00 €</b>



Mt **Inox** Ø 35 mm

## Barra Angular 90°

Barra Angular 90°  
Angle Bar 90°  
Barre d'Angle 90°



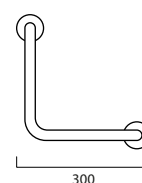
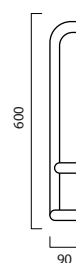
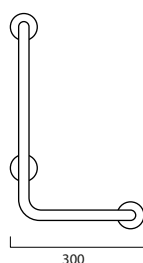

Ref.			€/Un.
0100.1120	30x30	N/A	<b>50,00 €</b>
0100.1130	60x30		<b>80,00 €</b>
0100.1140	60x30		<b>80,00 €</b>



Mt **Inox** Ø 35 mm

## Barra Parede/Chão

Barra Pared/Suelo  
Wall/Floor Bar  
Barre Mur/Sol

Ref.			€/Un.
0100.1210	76x48		<b>105,00 €</b>
0100.1220	76x48		<b>105,00 €</b>

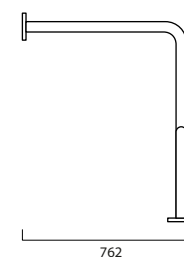
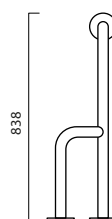

# Barras de Apoio e Ajudas Técnicas em Inox

Barras y Ayudas Técnicas en Inox | Grab Bars and Mobility Technic Support in Inox | Barres d'Apui et Aides Techniques dans Inox



Mt **inox** Ø 35 mm

## Barra Apoio 3P

Barra Apoyo 3P

Grab Bar 3P

Barre d'Apui 3P

**Ref.** **€/Un.**

0100.1310 75x14 **100,00 €**

0100.1320 75x14 **100,00 €**

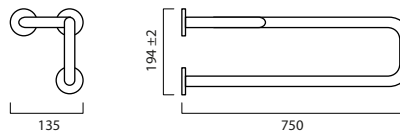

Mt **inox** Ø 35 mm

## Apoio Rebatível

Barra Abatible

Folding Bar

Barre Rabattable

**Ref.** **€/Un.**

0100.1410 80x20 **125,00 €**

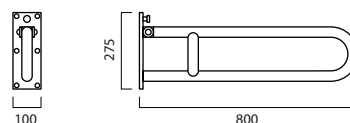

Mt **inox** Ø 35 mm

## Apoio Rebatível c/ Porta Rolo

Barra Abatible c/ Portarollo

Folding Bar w/ Paper Holder

Barre Rabattable a/ Porte-Roleaux

**Ref.** **€/Un.**

0100.1420 80x20 **130,00 €**

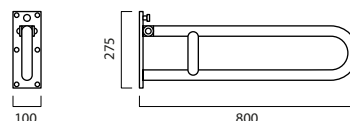

Mt **inox**

## Banco Chuveiro Rebatível

Asiento Ducha Plegable

Folding Shower Seat

Siège de Douche Rabattable

**Ref.** **€/Un.**

0100.1520 **160,00 €**

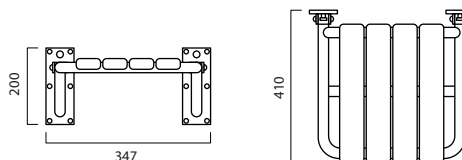

Mt **inox**

## Banco p/Banheira

Asiento de Bañera

Bathtub Seat

Siège p/ Baignoire

**Ref.** **€/Un.**

0100.1530 **160,00 €**

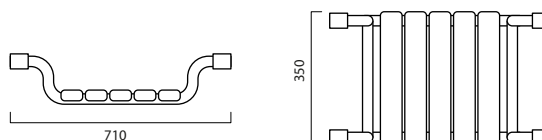

# Acessórios de Banho Público

Accesorios Baño Público | Public Bathroom Accessories | Accessoires de Bain Commune



## Bigflow



### Secamãos

Secador de manos  
Hand dryer  
Sèche-mains

2050 W

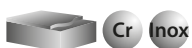

0299.0028 **282,00 €**



0299.0029 **260,00 €**



0299.0030 **200,00 €**



0299.0031 **150,00 €**

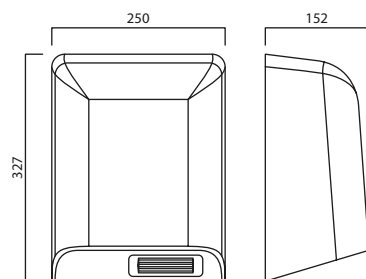

### Dispensador de papel

Dispensador de papel  
Paper dispenser  
Distributeur de papier



0299.0087 **58,00 €**



0299.0088 **58,00 €**



0299.0089 **52,00 €**

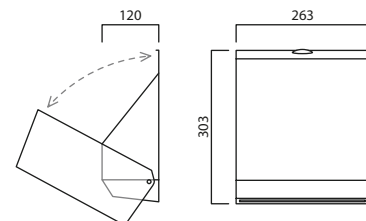

### Dispensador de sabão

Dispensador de jabón  
Soap dispenser  
Distributeur de savon

1200 ml



0299.0059 **55,00 €**



0299.0060 **55,00 €**



0299.0061 **54,00 €**

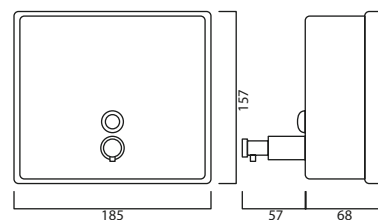

### Doseador de Sabão

Dosificador Jabón  
Soap Dispenser  
Distributeur Savon

900 ml



0299.0078 **14,50 €**

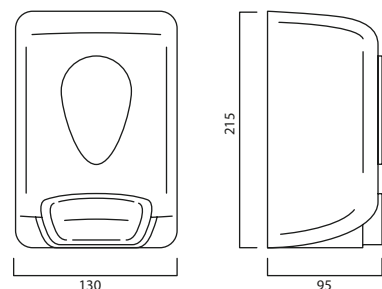

# Acessórios de Banho Público

Accesorios Baño Público | Public Bathroom Accessories | Accessoires de Bain Commune



**Dispensador de Sabão Automático**  
 Dispensador de Jabón Automático  
 Automatic Soap Dispenser  
 Distributeur Automatique de Savon

- 1.5 + x 4

1200 ml



0299.0072 **123,00 €**



0299.0073 **120,00 €**

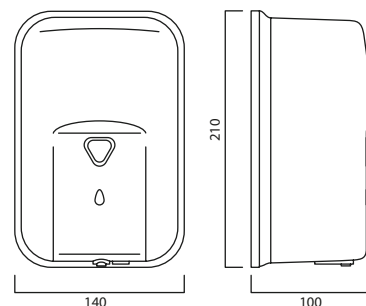

**Dispensador de papel**  
 Dispensador de papel  
 Paper dispenser  
 Distributeur de papier



0299.0095 **21,00 €**

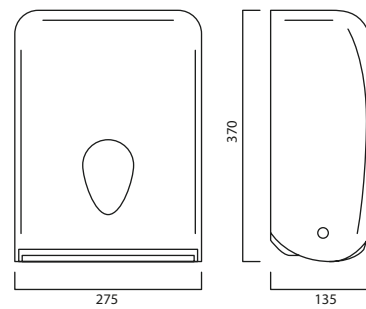

**Dispensador de papel**  
 Dispensador de papel  
 Roll holder  
 Distributeur de papier



0299.0122 **20,95 €**

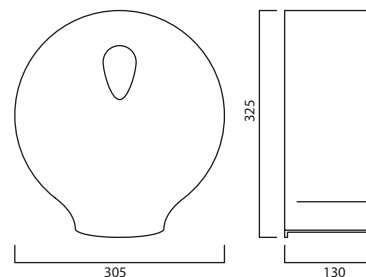

**Dispensador de papel**  
 Dispensador de papel  
 Roll holder  
 Distributeur de papier



0299.0116 **48,00 €**



0299.0117 **48,00 €**



0299.0118 **48,00 €**

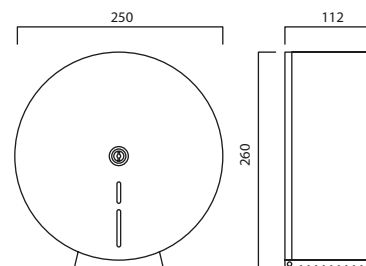

**Dispensador de papel**  
 Dispensador de papel  
 Paper dispenser  
 Distributeur de papier



0299.0135 **92,00 €**



0299.0136 **92,00 €**



0299.0137 **65,00 €**

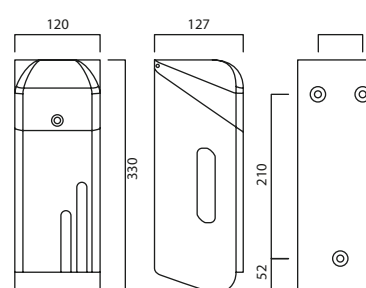





Cr

**Porta Toalhas**  
Toallas de puerta  
Towel Shelf  
Tabelette Porte-Serviette

**Ref.** €/Un.

6011.0101 **50,00 €** 1

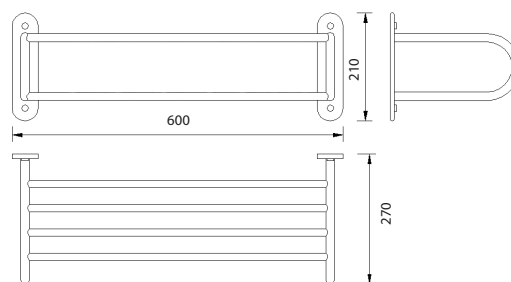

Cr Lt

**Saboneteira Canto**  
Jabonera Angular  
Corner Shelf  
Porte Savon Angular

**Ref.** €/Un.

4506.0521 **35,00 €** 1

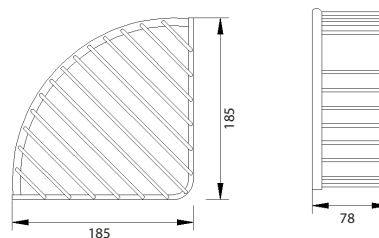

Cr Lt

**Saboneteira Frontal**  
Jabonera Frontal  
Front Shelf  
Porte Savon Rectangulaire

**Ref.** €/Un.

4506.0531 **40,00 €** 1

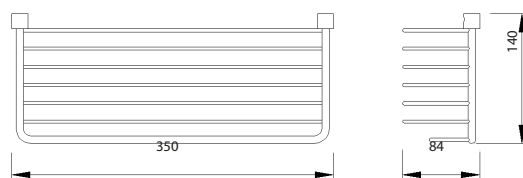

Cr

**Dispensador Sabão**  
Dispensador Jabón  
Soap Dispenser  
Distributeur de Savon

**Ref.** €/Un.

4559.0101 500 ml **20,00 €** 1

4559.0105 800 ml **23,00 €** 1

4559.0110 1000 ml **28,00 €** 1

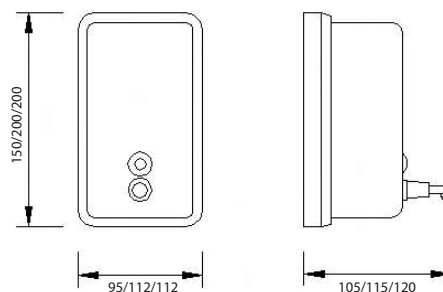

Inox

**Balde Pedal**  
Papelerera Pedal  
Pedal Open Bin  
Poubelle à Pédale

**Ref.** €/Un.

4558.1801 5 L **18,00 €** 1

4558.1901 8 L **22,00 €** 1

4558.2004 12 L **25,00 €** 1

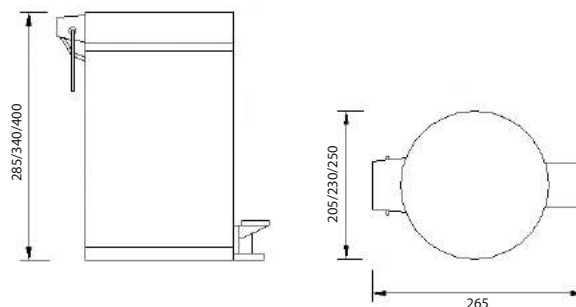

Cr Lt  
Ø 25

**Toalheiro Asa**  
Asidero Recto  
Grab Bar  
Barre Droit

**Ref.** €/Un.

6010.0114 30 cm **20,00 €** 1

6010.0115 50 cm **26,00 €** 1

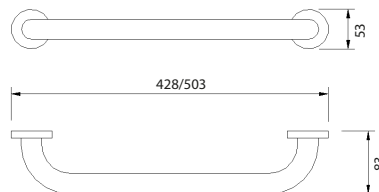



**Asa Segurança**  
Asidero Angular  
Angle Bar  
Barre Poignée

Ref.	€/Un.	
6011.0110	35,00 €	1
c/ Saboneteira		
6011.0111	50,00 €	1

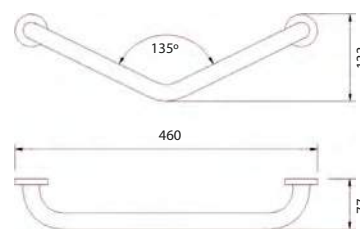

**Toalheiro Popular**  
Toallero Popular  
Towel Bar Popular  
Porte-Serviette Popular

Ref.		€/Un.	
4590.0130	30 cm	5,87 €	1
4590.0140	40 cm	7,00 €	1
4590.0150	50 cm	7,50 €	1
4590.0160	60 cm	8,00 €	1



**Cabide**  
Percha  
Hook  
Patère

Ref.		€/Un.	
4500.0103	3	7,50 €	1
4500.0104	4	9,50 €	1
4500.0105	5	12,50 €	1
4500.0106	6	14,50 €	1
4500.0107	7	17,00 €	1



**Porta Rolo**  
Portarollos  
Paper Holder  
Porte-Roleaux

Ref.	€/Un.	
4591.0100	1,60 €	5



**Porta Rolo c/ Tampa**  
Portarollos c/ Tampa  
Paper Holder w/ Lead  
Porte-Roleaux a/ Couverture

Ref.	€/Un.	
4594.0100	9,00 €	5



**Porta Piaçaba**  
Escobillero  
Toilet Brush  
Porte Balayette

Ref.	€/Un.	
4556.0001	18,00 €	1

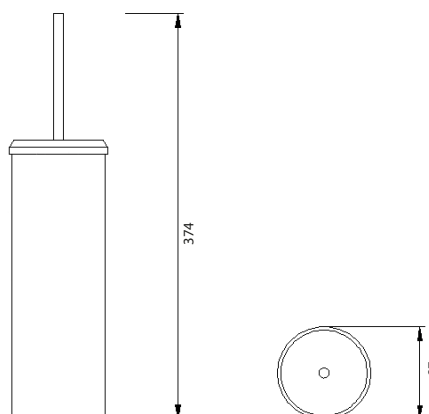

# 1.3

## Sifões, Válvulas e Tubos Flexíveis



**Preços alterados!**

**Consulte os nossos serviços comerciais  
ou a tabela Jimten 17 Ed. 31 | Abril 2017  
em vigor desde 01/06/2017**





# Sifões, Válvulas e Tubos Flexíveis



**S-31**

**JUNTAFIX**

EN  
274

Curvo extensible, saída horizontal, racor.  
Curva extensível, saída horizontal, porca.

Ref.		€/Un.	
06046	1 1/4		50
06028 ■	1 1/2		50
06366 ■	1 1/4X1 1/2		50



**S-69**

**JUNTAFIX**

EN  
274

Botella corto extensible, saída horizontal, racor.  
Garrafa curto extensível, saída horizontal, porca.

Ref.		€/Un.	
04016	1 1/4		50
04058 ■	1 1/2		50



**S-276**

EN  
274

Botella corto extensible, saída horizontal, válvula fregadero.  
Garrafa curto extensível, saída horizontal, lava loiça 115.

Ref.		€/Un.	
02438 ■	1 1/2		50



**S-380**

EN  
274

Sifón para urinario, botella, corto extensible.  
Sifão urinol, garrafa curto, extensível.

Ref.		€/Un.	
04528 ■	1 1/2		25



**S-865**

Sifón botella Juntafix, extensible, saída horizontal, racor.  
Sifão, garrafa Juntafix, extensível, saída horizontal, porca.

Ref.		€/Un.	
01656	1 1/4		25



**S-265**

Sifón sencillo para empotrar, saída encolar, toma lavadora.  
Sifão simples para embutir, saída colar Ø40, ligação máquina lavar.

Ref.		€/Un.	
19028	40		10
19058	40 MACHO		10





## Manguito Flexíveis / Uniões Flexíveis





### A - 103

Manguito flexible - No ecolable

(Para conexiones de difícil acceso. No utilizar como sifón de desagüe)

Tubo flexível - Não colável

(para ligações de difícil acesso. Não utilizar como sifão de saída)

Ref.		€/Un.	
22042	1 1/4-32/40	<b>3,78 €</b>	50
22043	1 1/2-40/50	<b>4,01 €</b>	50





### A - 111

Manguito flexible bocas lisas - No ecolable

(Para conexiones de difícil acceso. No utilizar como sifón de desagüe)



Tubo flexível bocas lisas - Não colável

(para ligações de difícil acesso. Não utilizar como sifão de saída)

Ref.		€/Un.	
22048	32/40-32/40	<b>4,52 €</b>	50
22049	40/50-40/50	<b>5,25 €</b>	50



### A - 104

Con junta conica / vedação cônica

Ref.		€/Un.	
22044	1 1/4-32/40	<b>3,99 €</b>	50
22045	1 1/2-40/50	<b>4,12 €</b>	50



### A - 119

Con junta plana / vedação liso

Ref.		€/Un.	
22066	MIN.270 MAX.440 1 1/4"-32/40	<b>3,73 €</b>	50

### A - 120

Con junta cónica / vedação cônica

Ref.		€/Un.	
22067	MIN.270 MAX.440 1 1/4"-32/40	<b>3,47 €</b>	50



### S - 582

**JUNTAFIX**

Válvula con sistema de apertura click-clack Ø 66



(chapa de acero inoxidable Ø 70) con tubo flexible

(Para conexiones de difícil acceso. No utilizar como sifón de desagüe)

Válvula con sistema de apertura/fecho click-clack Ø 66

(chapa aço inox Ø 70) con tubo flexível

(para ligações de difícil acesso. Não utilizar como sifão de saída)

Ref.		€/Un.	
11336	1 1/4X32/40 840-410	<b>12,08 €</b>	50
11338	1 1/2X40/50 995-410	<b>13,13 €</b>	50



### S - 382

EN  
274



**JUNTAFIX**

Válvula Ø 70 con tubo flexible

(Para conexiones de difícil acceso. No utilizar como sifón de desagüe)

Válvula Ø 70 con tubo flexível

(para ligações de difícil acesso. Não utilizar como sifão de saída)

Ref.		€/Un.	
11316	1 1/4 840-410	<b>6,72 €</b>	50
11318	1 1/2 995-410	<b>6,93 €</b>	50



EN  
274

**S-7**

**JUNTAFIX**

Desagüe sifónico doble, extensible, salida horizontal, con racores.  
Saída sifónica dupla, extensível, saída horizontal, com porcas.

Ref.		€/Un.	
05018	1 1/2		30



Normal: Max. 415  
Especial: Max. 708

**S-30**

**JUNTAFIX**

Sifón curvo doble, extensible, salida orientable, con racores y toma auxiliar.  
Sifão curvo duplo, extensível, saída orientável, com porcas e ligação auxiliar.

Ref.		€/Un.	
07028	1 1/2		30
07068	1 1/2		25



**S-232**

Colector central sifónico, extensible, salida horizontal, válvulas.  
Colector central sifónico, extensível, saída horizontal, válvulas.

Ref.		€/Un.	
05388	1 1/2		25



**S-233**

Curvo doble, extensible, salida orientable, válvulas y toma auxiliar.  
Curva duplo, extensível, saída orientável, válvulas e ligação auxiliar.

Ref.		€/Un.	
07088	1 1/2		25



**S-472**

Colector central sifónico, extensible, salida horizontal, válvulas de cesta con rebosadero.  
Colector central sifónico, extensível, saída horizontal, válvulas cesta com respiro.

Ref.		€/Un.	
05628	1 1/2 X 115		15



**S-473**

Colector central sifónico, extensible, salida horizontal, válvulas de cesta.  
Colector central sifónico, extensível, saída horizontal, válvulas cesta.

Ref.		€/Un.	
05638	1 1/2 X 115		15



**S - 13**  
Fregadero.  
Banca.

EN 274 **JUNTAFIX**

Ref.		€/Un.	
11016	11/4		50
11028	11/2		50



**S - 35**  
Lavabo-bidé.  
Lavatório-bidé.

EN 274 **JUNTAFIX**

Ref.		€/Un.	
10036	11/4		50
10048	11/2		50



**S - 540**

**JUNTAFIX**  
**CLICKCLACK**

Válvula lavabo/bidé con sistema de apertura Click-Clack en ABS cromo.  
Chapa de acero inoxidable Ø70.  
Válvula lavatório/bidé con sistema de abertura/fecho Click-Clack em ABS cromo. Chapa de aço inoxidável Ø70.

Ref.		€/Un.	
10186	1 1/4 X 63		10
10188	1 1/2 X 63		10



**S - 160**

Fregadero acero inoxidable.  
Banca aço inoxidável.

EN 274

Ref.		€/Un.	
11068	11/2 x 115		50



**S - 501**

**JUNTAFIX**

Válvula desagüe con tapón ABS cromo (chapa acero inoxidable).  
Válvula de saída com tampão ABS cromo (chapa aço inoxidável).

Ref.		€/Un.	
10076	1 1/4 X 63		25
10078	1 1/2 X 63		25
10006	1 1/4 X 70		25



**A - 158**

**CLICKCLACK**

Conjunto embellecedor sistema de apertura/cierre Click-Clack.  
Conjunto embelezador abertura/fecho Click-Clack.

Ref.		€/Un.	
22350	70x66		25

## Válvulas de Cesta/ Válvulas de Cesta



Altura Reducida  
Altura Reduzida

**S - 237**

**JUNTAFIX**

Válvula cesta con rebosadero rectangular flexible, fregadero acero inox., gres, composite, fibra, etc.  
Válvula cesta com respiro flex, banca aço inox., granito, composto, fibra, etc

Ref.		€/Un.	
14059	1 1/2X115		25



**S - 337**

Válvula cesta con rebosadero redondor flexible, fregadero acero inox., gres, composite, fibra, etc.  
Válvula cesta com respiro flex, banca aço inox., granito, composto, fibra, etc

Ref.		€/Un.	
11308	1 1/2X115		10



Altura Reducida  
Altura Reduzida

## S - 26

**JUNTAFIX**

Válvula cesta fregadero acero inoxidable, gres, composite, fibra, etc.  
Válvula cesta banca aço inoxidável, granito, composto, fibra, etc.

Ref.		€/Un.	
22185	1 1/2X115		25



Ext. Ø25

## S - 27

Salida horizontal, orientable con tuerca Ø40.  
Saída horizontal, orientável com porca Ø 40.

Ref.		€/Un.	
15338	1 1/2X40		50

### Modelos Especiales/Modelos Especiais

Long.  
1 m.  
Flex. Ø25



## S - 250

Salida plana salida horizontal con tuerca Ø40.  
Saída recta saída horizontal com porca Ø 40.

Ref.		€/Un.	
15388	1 1/2 X 40		50



Flex. Ø25

EN  
274

## S - 335

Salida horizontal, orientable con tuerca Ø40.  
Saída horizontal, orientável com porca Ø 40.

Ref.		€/Un.	
15618	1 1/2X40		10



EN  
274

## S - 28

plato ducha, salida horizontal.  
Base chuveiro, saída horizontal.

**JUNTAFIX**

Ref.		€/Un.	
12026	1 1/4 x 70		50
12038	1 1/2 x 70		50
12148	1 1/2 x 80		50
12058	1 1/2 x 115		50



## S - 134

Sifónica, plato ducha, salida horizontal.  
Base chuveiro, saída vertical PVC colar.

**JUNTAFIX**

Ref.		€/Un.	
12068	1 1/2 x 80		50
12078	1 1/2 x 70		50
12108	1 1/2 x 115		50





## S - 130

En Bolsa

SIFÓNICAS

EN 274

Válvula para plato ducha con orificio de salida Ø50, 60 ó 90 mm.

\* (Adaptable a platos de ducha de gres, fibra, cerámica y acero inoxidable).

Válvula para base chuveiro con saída Ø50, 60 ou 90 mm.

\* (Adaptável a bases de chuveiro de granito, fibra, cerâmica e aço inoxidável).

Ref.		Color Cor	€/Un.	
B12168	■ 1 1/2	Cromo		25
B12198*	■ 1 1/2	Cromo		25
B12199	■ 1 1/2	Cromo		25



## S - 130

Tapa expansión, embelezador acero inoxidable. Especial GAS.

Tampa expansão, embelezador aço inoxidável. Especial GAS.

Ref.		€/Un.	
26030	110		50



A Labiada



B JUNTAFIX Labiada



C JUNTAFIX Plana

Salida con junta para tubos lisos no encolables Ø 40  
Saída com vedação para tubos lisos não coláveis Ø 40

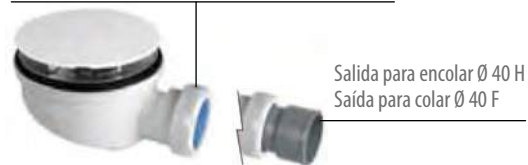

EN 274

## S - 578

SIFÓNICAS

JUNTAFIX

Ref.		Ø Salida Ø Saída	Color Cor	€/Un.	
12279	■ 1 1/2 x 115	90	Inox		20
12519	■ 1 1/2 x 115	90	Inox Cromo		20
12869	■ 1 1/2 x 115	90	Blanco		20

En Bolsa

SIFÓNICAS

B12279	■ 1 1/2 x 115	90	Inox		20
--------	---------------	----	------	--	----

Válvula para plato ducha con orificio de salida Ø90, altura reducida, sifon 30 mm con brida metálica de fijación.

Válvula para base chuveiro con saída Ø90 mm, altura reduzida, sifão 30 mm com braçadeira metálica de fixação.



## S - 130

Tapa expansión, embelezador acero inoxidable.

Tampa expansão, embelezador aço inoxidável.

Ref.		€/Un.	
26010	90		50
26000	125		50



## S - 412

Tapa expansión.

Tampa expansão.

Ref.		€/Un.	
26040	125 x 145		50

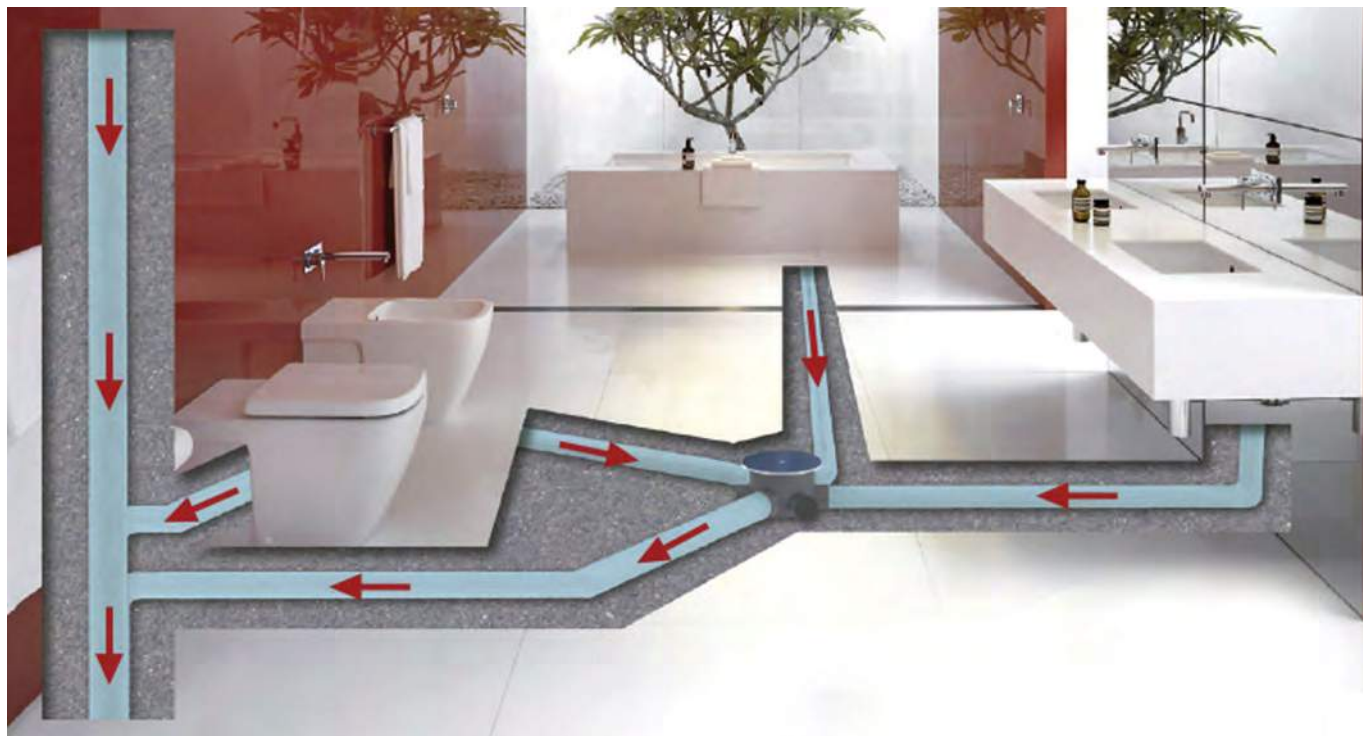

### S - 130 V

Tapa expansión con embellecedor de acero inoxidable.  
Para botes sifónicos de baja cota. Con válvula de aireación integrada.  
Tampa expansão com embelezador de aço inoxidável.  
Para sifões de pavimento com cota baixa. Com válvula de respiro integrada.

Ref.		€/Un.	
26060	110		20



### PVC

### S - 153

Bote PVC, tapa expansión, embellecedor de acero inoxidable, 5 entradas.  
Sifão PVC, tampa expansão, embellecedor de acero inoxidable, 5 entradas

Ref.		€/Un.	
09130	40X50		25

# 1.4

## Sifões e Tubos Flexíveis Cromados



**Preços alterados!**

Consulte os nossos serviços comerciais  
ou a tabela Jimten 17 Ed. 31 | Abril 2017  
em vigor desde 01/06/2017









### S - 182

Botella extensible, salida horizontal con racor.  
Garrafa extensível, saída horizontal com porca.

Ref.		Color Cor	€/Un.	
04096	1 1/4	Cromo		10
04098	1 1/2	Cromo		10
04236	1 1/4X1 1/2	Cromo		10



### S - 392

Botella extensible para urinario.  
Garrafa extensível para urinol.

EN  
274  
ABS

Ref.		Color Cor	€/Un.	
04538	1 1/2	Cromo		10



Con junta plana. / Vedação liso.

### A - 131

Manguito flexible cromado. No encolable.  
(Para conexiones de difícil acceso. No utilizar como sifón de desagüe).  
Tubo flexível em PP metalizado cromo.  
(Para ligações de difícil acesso. Não utilizar como sifão de saída).

PP

Ref.		MAX-MIN	€/Un.	
22089	1 1/4X32/40	825-360		50
22090	1 1/2X40/50	950-365		50



### S - 402

Botella extensible con racor, salida horizontal con alargadera 180 mm y plafón.  
Garrafa extensível com porca, saída horizontal com aumento 180 mm e espelho.

ABS

Ref.		Color Cor	€/Un.	
06316	1 1/4	Cromo		10

### A - 132 Con junta cónica. / Vedação cónica.

Ref.		MAX-MIN	€/Un.	
22091	1 1/4X32/40	825-360		50
22092	1 1/2X40/50	950-365		50
22341	1 1/4X32	800-370		50

### A - 133 Con junta plana. / Vedação liso.

Ref.		MAX-MIN	€/Un.	
22093	1 1/4X32/40	445-255		50
22344	1 1/4X32	410-230		50

### A - 134 Con junta cónica. / Vedação cónica.

Ref.		MAX-MIN	€/Un.	
22094	1 1/4X32/40	445-255		50
22343	1 1/4X32	410-230		50



### S - 428

Válvula de Ø70 con tubo flexible cromado. (Para toma de difícil acceso.  
No utilizar como sifón de salida).  
Válvula Ø70 con tubo flexível metalizado. (Para ligações de difícil acesso.  
Não utilizar como sifão de saída).

PP/ABS/AC. INOX

EN  
274

Ref.		MAX-MIN	Color Cor	€/Un.	
11319	1 1/4"	900-460	Cromo A1		50
11320	1 1/2"	1010-460	Cromo A1		50
11026	70-1 1/4	850-410	Cromo B1		50

# 1.5

## Acoplamentos para Sanitas

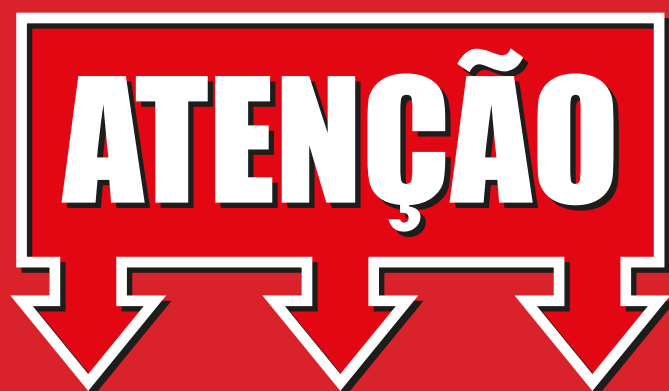

**Preços alterados!**

**Consulte os nossos serviços comerciais  
ou a tabela Jimten 17 Ed. 31 | Abril 2017  
em vigor desde 01/06/2017**





**S - 495**  
Manguito inodoro excêntrico vertical.  
Calção sanita excêntrico vertical.

Ref.		€/Un.	
21421	110		1



**S - 486**  
Manguito inodoro acodado corto, ajustable interior. (Para inodoros con salida Dual).  
Calção sanita curvo corto, ajustável interior. (Para sanitas com saída Dual).

Ref.		€/Un.	
21390	110		12



**S - 386**  
Manguito inodoro acodado, ajustable interior. (Para inodoros con salida Dual).  
Calção sanita curvo, ajustável interior. (Para sanitas com saída Dual).

Ref.		€/Un.	
21300	110		12

## Manguitos Inodoro Flexibles / Calção Sanita Elástico



**S - 218**  
Manguito inodoro elástico.  
Calção sanita elástico.

Ref.		€/Un.	
21120	90		45
21090	110		45



**S - 219**  
Manguito inodoro elástico, excêntrico.  
Calção sanita elástico, excêntrico.

Ref.		€/Un.	
21130	90		45
21110	110		45



FLEXIBLE  
FLEXÍVEL  
EXTENSIBLE  
EXTENSÍVEL  
**Nuevo diseño  
Más adaptable  
Novo desenho  
Mais adaptável**

**S - 500**  
Manguito inodoro extensible, para conexiones de difícil acceso. Máx. 535 mm - Min. 225 mm.  
Calção sanita extensível, para ligações de difícil acesso. Max. 535 mm - Min. 225 mm.

Ref.		€/Un.	
21400	110		20

# 1.6

## Base de Duche Obra - Linnum



**Preços alterados!**

Consulte os nossos serviços comerciais  
ou a tabela Jimten 17 Ed. 31 | Abril 2017  
em vigor desde 01/06/2017









# Base de Duche Obra - Linnum



## Caleiras c/ Grelha Base de Duche Obra - Linnum

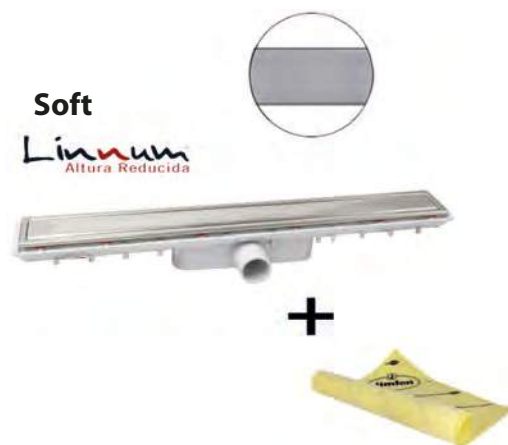
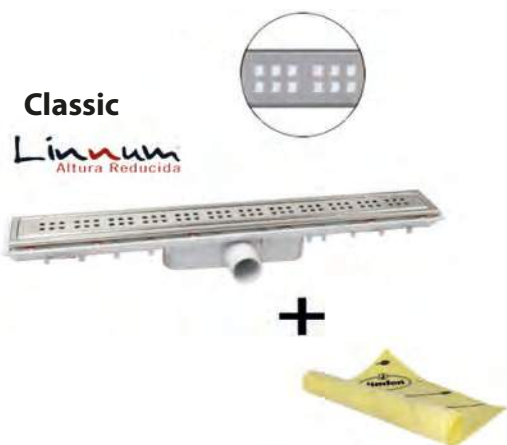

Caleira com grilha CLASSIC 50mm c/ lâmina geotextil 1,5x2m

Ref.	Largo mm Longo mm	Ø Salida Ø Saída	€/Un.	
B13416	650X40 ENCOLAR	40H / 50M		1
B13417	750X40 ENCOLAR	40H / 50M		1
B13418	850X40 ENCOLAR	40H / 50M		1
B13419	950X40 ENCOLAR	40H / 50M		1

Caleira com grilha SOFT 50mm c/ lâmina geotextil 1,5x2m

Ref.	Largo mm Longo mm	Ø Salida Ø Saída	€/Un.	
B13446	650X40 ENCOLAR	40H / 50M		1
B13447	750X40 ENCOLAR	40H / 50M		1
B13448	850X40 ENCOLAR	40H / 50M		1
B13449	950X40 ENCOLAR	40H / 50M		1

## Sumidouro Base de Duche Obra - Linnum



Classic



Soft

Sumidouro sífónico para base de chuveiro de obra com saída horizontal. Grelha em aço inoxidável de 112x112mm com tela impermeabilizante de lâmina geotextil premontada.

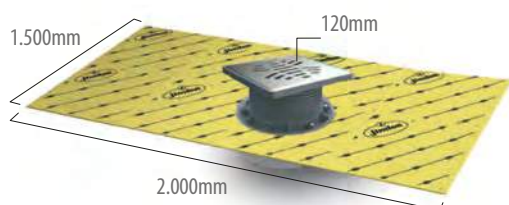

### Grelha SOFT

Possibilidade de transformar a tampa para rebaixável e preencher com o mesmo pavimento.

Ref.	Tela	Ø Salida Ø Saída	€/Un.	
B13014	1'5 x 2 Class	40H / 50M		1
B13015	1'5 x 2 Soft	40H / 50M		1
B13012	1'2 x 1'5 Class	40H / 50M		1
B13013	1'2 x 1'5 Soft	40H / 50M		1

# 1.7

## Trituradores Sanitários e Estação de Bombagem



**Preços alterados!**

Consulte os nossos serviços comerciais  
ou a tabela Jimten 17 Ed. 31 | Abril 2017  
em vigor desde 01/06/2017









Una completa gama de productos adaptada a cualquier necesidad.  
Uma gama completa de produtos adaptada a qualquer necessidade.

**Trituradores sanitarios** con toma WC y conexiones auxiliares Ø40mm. Salida vertical 32mm encolable.  
Equipados con válvula antirretorno. Sistema Casete de fácil mantenimiento. Funcionamiento silencioso.

**Trituradores sanitários** com tomada WC e conexões auxiliares Ø40mm. Saída vertical 32mm, união por colagem.  
Equipados com válvula antirretorno. Sistema Cassete de fácil manutenção. Funcionamento silencioso.



1 toma WC. 2 tomas laterales (Ø40mm).  
Motor: 550 W.  
Bombeo hasta 6 m de altura o 62 m en horizontal.



6 m ↑



**T - 604**

Ref. € /Un. 

75001  1



1 toma WC. 1 toma lateral derecha (Ø40mm).  
Motor: 470 W.  
Bombeo hasta 5 m de altura o 52 m en horizontal.



5 m ↑



**T - 502**

Ref. € /Un. 

75301  1



1 toma WC.  
Motor: 470 W.  
Bombeo hasta 5 m de altura o 52 m en horizontal.



5 m ↑



**T - 501**

Ref. € /Un. 

75701  1



1 toma WC. 1 toma lateral (Ø40mm).  
Motor: 470 W.  
Bombeo hasta 5 m de altura o 52 m en horizontal.



5 m ↑



**T - 502**

Ref. € /Un. 

75601  1



1 toma WC. 2 tomas laterales (Ø40mm).  
Motor: 470 W.  
Bombeo hasta 5 m de altura o 52 m en horizontal.



5 m ↑



**T - 503**

Ref. € /Un. 

75501  1

1 tomada WC. 2 tomadas laterais (Ø40mm).  
Motor: 470 W.  
Bombeio até 5 m de altura o 52 m na horizontal.

# Trituradores Sanitários e Estação de Bombagem



## Estación de bombeo

Equipado con válvula antirretorno.  
Salida vertical 32mm encolable.  
Con sistema Caset de fácil mantenimiento.  
Motor: 390 W.  
Bombeo hasta 7m de altura o 72 m en horizontal.  
Silencioso.



## Estação de bombagem

Equipado com válvula antirretorno.  
Saída vertical 32mm união por colagem.  
Com sistema Cassete de fácil manutenção.  
Motor: 390 W.  
Bombeo até 7m de altura ou 72 m na horizontal.  
Funcionamento Silencioso.

3 tomas laterales (Ø40mm).  
2 tomas superiores (Ø40mm, incluye tina electrodoméstico).  
Motor: 390 W.  
Bombeo hasta 7 m de altura o 72 m en horizontal.

3 tomadas laterais (Ø40mm).  
2 tomadas superiores (Ø40mm, inclui ligação electrodomésticos).  
Motor: 390 W.  
Bombeo até 7 m de altura o 72 m na horizontal.

**CICLON LS** 7 m ↑

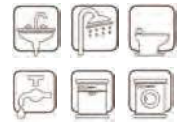

**EB - 705**

Ref. €/Un.

75401 1





# 1.8

## Autoclismos, Tamos Sanita, Válvulas e Sifões

Cisternas, Tapas WC, Válvulas y Sifones  
Cisterns, Toilet Seat, Valves and Siphons  
Chassé D'Eau/Abattants WC/Vannes et Siphons



**SANIJATO**



Autoclismo Mira  
Cisterna Mira  
Cistern Mira  
Chasse d'Eau Mira

4603.0300 **35,00 €**



Start  
Stop



4610.0306 **5,75 €**



4610.0323 **1,85 €**



4610.0304 **1,90 €**



4610.0220 **0,20 €**



4610.0320 **0,20 €**



4610.0303 **5,50 €**

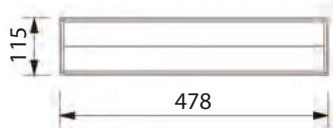
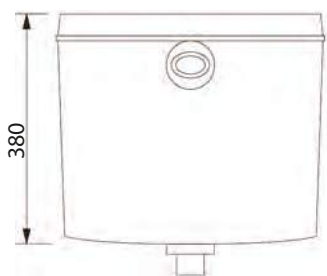

4610.0302 **4,50 €**



4610.0300 3/8 **6,70 €**

4610.0301 1/2 **7,00 €**

## SANIJATO®



Autoclismo EUROECO  
Cisterna EUROECO  
Cistern EUROECO  
Chasse d'Eau EUROECO

4607.0300 **25,03 €**

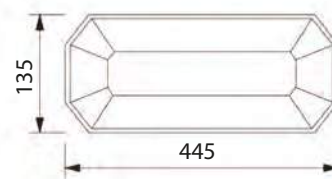
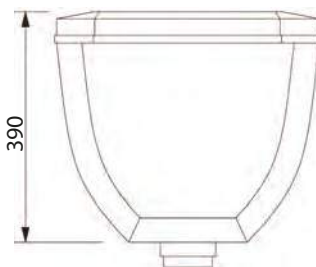

4615.0457 **5,15 €**



4615.0450 **8,00 €**



4615.0400 **6,00 €**



4615.0459 **1,55 €**



Autoclismo MEBRA  
Cisterna MEBRA  
Cistern MEBRA  
Chasse d'Eau MEBRA

4600.2700 **26,00 €**

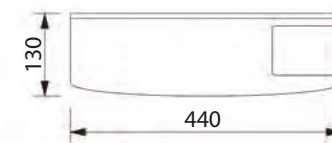
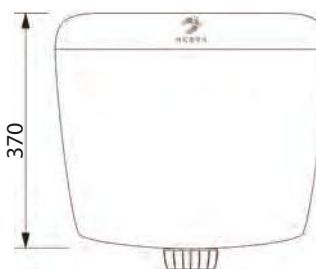

4615.0150 **5,15 €**



4615.0250 **8,30 €**



4615.0100 **6,00 €**



# Torneiras e Acessórios

Flotadores y Accesorios | Inlet Valves and Accessories | Robinets à Flotteur



## DUO

## UO

## OO



46105  
Torneira Boia DUO  
Grifo Flotador DUO  
Fill Valve DUO  
Robinet Flotteur DUO

Ref. €/Un.

4610.0105 13,00 € 40



Instalação lateral  
Instalación lateral



Instalação inferior  
Instalación inferior

Inclui filtro de impurezas  
Incluye filtro de impurezas

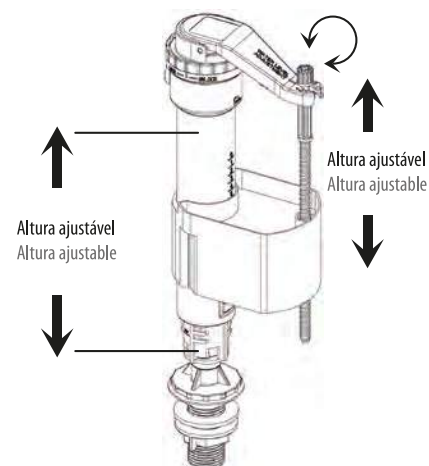

Altura ajustável  
Altura ajustable

Altura ajustável  
Altura ajustable



Descarga Dupla  
Descarga Doble

46110  
Mecanismo Descarga Dupla Universal DUO  
Mecanismo Descarga Doble Universal DUO  
Universal Double Flush Valve DUO  
Mécanisme Universel à Double Poussoir DUO

Ref. €/Un.

4610.0110 17,00 € 30



Instalação fácil  
Fácil instalación



Economia de água  
Ahorro de agua



Inclui parafusos  
Incluye tornillos



Descarga ajustável  
Descarga regulable



46115  
Pack DUO (torneira + mecanismo)  
Pack DUO (grifo + mecanismo)  
Pack DUO (fill valve + flush valve)  
Pack DUO (Robinet + Flotteur)

Ref. €/Un.

4610.0115 29,00 € 20



Vedação p/ Torneira DUO  
Junta p/ Grifo DUO  
Stopping Joint f/ Valve DUO  
Joint p/ Flotteur DUO

Ref. €/Un.

4610.0201



Vedação Silicone Mecanismo DUO  
Junta Silicona p/ Mecanismo DUO  
Flush Valve Silicon Joint DUO  
Joint de Silicone p/ Mécanisme DUO

Ref. €/Un.

4610.0211 1,20 €



Pulsador Mecanismo DUO  
Pulsador Mecanismo DUO  
Flush Valve Button DUO  
Pulseur p/ Mécanisme DUO

Ref. €/Un.

4610.0207 5,00 €



Kit Fixação Autoclismo DUO  
Kit Fijación Cisterna DUO  
Cistern Fixing Kit DUO  
Kit Fixation Chassé d'Eau DUO

Ref. €/Un.

4610.0209 5,00 €

# Torneiras e Acessórios

Flotadores y Accesorios | Inlet Valves and Accessories | Robinets à Flotteur



4611  
Torneira Autoclismo Inferior  
Grifo c/ Boya Inferior  
Bottom Entry Fill Valve  
Robinet à Flotteur Inférieur

Ref.		€/Un.	
4610.0001	3/8	12,00 €	40



4612  
Torneira Autoclismo Lateral  
Grifo c/ Boya Lateral  
Side Fill Valve  
Robinet à Flotteur Haut

Ref.		€/Un.	
4610.0002	3/8	11,00 €	40

# Válvulas, Sifões e Acessórios

Válvulas, Sifones y Accesorios | Valves, Siphones and Accessories | Bonde, Siphons et Accessoires



Tubo Articulado MULTI  
Tubo Articulado MULTI  
Flexible Pipe MULTI  
Tube Articulé MULTI

Ref.	€/Un.	
0151.0050	2,65 €	50

**Tubo  
Articulado  
Multi**



# Vedação Cisterna / Emboques Sanita

Juntas Cisterna/Inodoro | Cistern/WC Gaskets | Joint Chassé/Cuvette



186VC  
Vedação Cisterna Junta Cisterna  
Cistern Gasket Joint Chassé D'Eau

Ref.	€/Un.	
0186.0500	3,25 €	10



182EI  
Emboque Sanita Interior Junta Inodoro Interior  
Inner WC Gasket Joint de Cuvette Intérieur

Ref.		€/Un.	
0182.0105	p/p/s/p	1,20 €	20
0182.0106	g/g/b/g	1,20 €	20
0182.0116	Ø28	1,00 €	20



182EE  
Emboque Sanita Exterior Junta Inodoro Exterior  
Outer WC Gasket Joint de Cuvette Extérieur

Ref.		€/Un.	
0182.0005	p/p/s/p	1,30 €	50
0182.0006	g/g/b/g	1,30 €	50
0182.0206	infantil	1,30 €	50

# Válvulas, Sifões e Acessórios

Válvulas, Sifones y Accesorios | Valves, Siphons and Accessories | Bonde, Siphons et Accessoires



150E  
Sifão Evolution  
Sifón Evolution  
Siphon Evolution  
Siphon Evolution

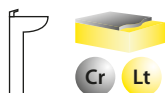

Ref.		€/Un.	
0150.0200	1 1/4"	20,00 €	20



150L  
Sifão Super Luxo  
Sifón Super Luxo  
Siphon Super Luxo  
Siphon Super Luxo

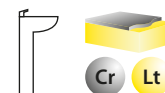

Ref.		€/Un.	
0150.0210	1 1/4"	27,00 €	20



150GV com Válvula / con Válvula / with Valve / avec Bonde  
Sifão Garrafa  
Sifón Botella  
Bottle Siphon  
Siphon Bouteille

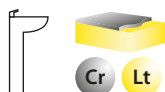

Ref.		€/Un.	
0150.0126	1 1/4"	16,00 €	20



150G sem Válvula / sin Válvula / no Valve / sans Bonde  
Sifão Garrafa  
Sifón Botella  
Bottle Siphon  
Siphon Bouteille

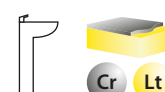

Ref.		€/Un.	
0150.0136	1 1/4"	19,00 €	20



150S com Válvula / con Válvula / with Valve / avec Bonde  
Sifão Tipo S  
Sifón Curvo  
S-Type Siphon  
Siphon Courbe

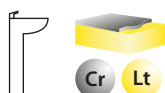

Ref.		€/Un.	
0150.0116	1 1/4"	20,00 €	20



150S sem Válvula / sin Válvula / no Valve / sans Bonde  
Sifão Tipo S  
Sifón Curvo  
S-Type Siphon  
Siphon Courbe

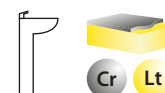

Ref.		€/Un.	
0150.0106	1 1/4"	20,00 €	20

# Válvulas, Sifões e Acessórios

Válvulas, Sifones y Accesorios | Valves, Siphones and Accessories | Bonde, Siphons et Accessoires



**154A**  
Válvula Automática c/ Vareta  
Válvula Automática c/ Varilla  
Pop-Up Valve w/ Bar  
Bonde Champignon a/ Barre



Ref.		€/Un.	
0154.0100	1 1/4"	5,50 €	50



**154B**  
Válvula Banheira Clic-clac  
Válvula Bañera Clic-clac  
Pop-Up Bath Waste  
Vanne Clic-Clac Baaignoire

Cb

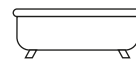

Ref.	€/Un.	
0154.2001	25,00 €	20



**151**  
Sifão Gordura PVC Sanijato  
Tapa sumidero c/ embudo  
Floor trap lid w/ funnel  
Siphon de Évier PVC

Ref.		€/Un.	
0151.0107	115	21,00 €	1



Acessórios Sifão  
Accesorios Sifón  
Siphon Accessoires  
Accessoires Siphon

Ref.		€/Un.
4610.0310	1	1,50 €
4610.0318	2	1,10 €
0151.0200	3	4,00 €
4610.0222	4	1,40 €
4610.0223	5	0,40 €



**690**  
Válvula Lavatório c/ Parafuso  
Válvula Lavabo c/ Tornillo  
Washbasin Waste w/ Screw  
Bonde Lavabo a/ Vis

Lt



Ref.		€/Un.	
0690.0005	1"	4,90 €	5
0690.0006	1 1/4"	4,90 €	5



**797**  
Taco p/ válvula  
Tapón p/ válvula  
Plug  
Bouchon

Ref.		€/Un.	
0797.0101		0,30 €	10
0797.0102		0,50 €	10



**144**  
Corrente Pérola Ø 3,2 mm  
Cadena Bolas Ø 3,2 mm  
Ball Chain Ø 3,2 mm  
Chaîne Boules Ø 3,2 mm

Ref.		€/Un.	
0144.0105	50 m	78,13 €	1



**169**  
Tampão Cego  
Roseta Ciega  
Stopper Hole  
Aveugle Cache-trou

Ref.		€/Un.	
0169.0101	Cr	1,00 €	50
0169.0301	Br	0,90 €	50



**145G**  
Garra p/ Corrente  
Enganche Cadena Bolas  
Ball Chain Attachment  
Chape p/ Chaîne à Boules

Ref.	€/100	
0145.0100	7,29 €	100



**145T**  
Triângulo p/ Corrente  
Anilla Triángulo  
Triangle Hook  
Lame Sertissage Chainette

Ref.	€/100	
0145.0200	9,69 €	100



# Válvulas Clic-Clac e Acessórios

Válvulas Clic-Clac y Accesorios | Pop-Up Valves and Accessories | Bondes Clic-Clac et Accessoires



154P  
Válvula clic-clac  
Válvula clic-clac  
Pop-up valve  
Bonde clic-clac

Ref.		€/Un.	
0154.1001	1 1/4	6,50 €	50



154G  
Válvula clic-clac grande  
Válvula clic-clac grande  
Big pop-up valve  
Bonde clic-clac grand

Ref.		€/Un.	
0154.1002	1 1/4	10,00 €	50



Válvula clic-clac grande c/ parafuso  
Válvula clic-clac grande c/ tornillo  
Big pop-up valve w/ screw  
Bonde clic-clac a/vis grand

Ref.		€/Un.	
0154.1060	1 1/4"	13,50 €	50



Válvula clic-clac pequena c/ parafuso  
Válvula clic-clac pequena c/ tornillo  
Small pop-up valve w/ screw  
Bonde clic-clac a/vis

Ref.		€/Un.	
0154.1050	1 1/4"	10,50 €	50



## Acessórios para Válvula Clic-Clac

Accesorios para Válvula Clic-Clac  
Pop-Up Valve Parts  
Accessoires de Valves Clic-Clac

Ref.		€/Un.	
0154.1505	1	1,50 €	10
0154.1501	2	0,15 €	10
0154.1503	3	3,50 €	10
0154.1507	4	0,60 €	10

# Sifões Pavimento, Tampas e Acessórios

Sifones Pavimento, Tapas y Accesorios | Floor Drains, Buffers and Accessories | Siphonde Sol, Tampons et Accessoires



Cr

149T  
Tampa ABS  
Tapa ABS p/ Sumidero  
ABS Lid f/ Floor Trap  
Tampon p/ Siphon de Sol ABS

Ref.		€/Un.	
0149.0108	Ø 90	1,96 €	1
0149.0109	Ø 110	2,54 €	1
0149.0110	Ø 125	4,55 €	1



Cr

149A  
Aro p/ Tampa ABS  
Aro p/ Tapa ABS  
Ring f/ ABS Lid  
Anneau p/ Tampon ABS

Ref.		€/Un.	
0149.0208	Ø 90	1,47 €	5
0149.0209	Ø 110	1,83 €	5
0149.0210	Ø 125	2,35 €	5



Cr

149RI  
Tampa Inox c/ Rosca  
Tapa Inox Sumidero c/ Rosca  
Floor Trap Lid w/ Thread  
Tampon Expansion a/ Vis

Ref.		€/Un.	
0149.0308	Ø 90	1,82 €	1
0149.0309	Ø 110	2,24 €	1
0149.0310	Ø 125	4,17 €	1



Cr

149EI  
Tampa Expansão Inox  
Tapa Expansión Inox c/ Rosca  
S. S. Floor Trap Expansion Lid  
Tampon Expansion Inox

Ref.		€/Un.	
0149.0318	Ø 90	3,85 €	1
0149.0319	Ø 110	4,69 €	1
0149.0320	Ø 125	5,42 €	1



Cr

147N  
Tampa latão  
Tapa Latón p/Sumidero  
Brass Lid f/Floor Drain  
Tampon Laiton p/Siphon de Sol

Ref.		€/Un.	
0147.0108	Ø 90	5,30 €	1
0147.0109	Ø 110	7,10 €	1
0147.0110	Ø 125	9,00 €	1



Cr

147L  
Tampa Latão Aba Larga  
Tapa Latón Ala Ancha  
Brass Lid Wide Brim  
Tampon Laiton Large Rebord

Ref.		€/Un.	
0147.0208	Ø 90	7,20 €	1
0147.0209	Ø 110	8,40 €	1
0147.0210	Ø 125	10,90 €	1



Cr

148  
Tampa Latão c/ Funil  
Sifón Cuibudo c/ Tapa Latón  
Floor Drain w/ Brass Lid  
Siphon de Sol a/ Tampon Laiton

Ref.		€/Un.	
0148.0108	Ø 90	10,00 €	1
0148.0109	Ø 110	12,00 €	1
0148.0110	Ø 125	17,00 €	1



Cr

153L  
Sifão Campainha Latão  
Sumidero Campana Latón  
Brass Bell Floor Drain  
Siphon de Sol Cloche Laiton

Ref.		€/Un.	
0153.0106	6 cm	5,00 €	1
0153.0108	8 cm	7,00 €	1
0153.0110	10 cm	10,00 €	1
0153.0112	12 cm	18,00 €	1



153P  
Sifão campainha PVC  
Sumidero Campana PVC  
PVC Bell Floor Drain  
Siphon de Sol Cloche PVC

Ref.		€/Un.	
0153.0009	40 cm	2,29 €	1
0153.0010	50 cm	2,71 €	1



152  
Sifão Pavimento PVC  
Bote Sifónico PVC  
PVC Floor Trap  
Siphon de Sol PVC

Ref.		€/Un.	
0152.0105	8 x 10	6,00 €	1
0152.0106	10 x 10	6,43 €	1

# Tamos Sanita

Tapas WC | Toilet Seats | Abattants WC



Concord

Ref.		€/Un.
4802.0300	MDF	<b>45,00 €</b>

Concorde, Veneza, Ares

4956.0300



Europa

Ref.		€/Un.
4800.0300	MDF	<b>45,00 €</b>

Europa, Monte Rosa, Lisboa, Algarve, Alvor, Estaco

4956.0300



TER001

Ref.		€/Un.
4760.0001	Termodur	<b>32,00 €</b>

Alfa, City, Dama, Estoril, Nexu, Regina, Stylo

4956.0501



TER020

Ref.		€/Un.
4760.0006	Termodur	<b>32,00 €</b>

Aqua, Eros, Image, Oceanus, Prestige

4956.0501



TER030

Ref.		€/Un.
4760.0010	Termodur	<b>25,00 €</b>

Europa plus, Spain

4956.0503



TER040

Ref.		€/Un.
4760.0040	Termodur	<b>32,00 €</b>

Europa, Munique, Apolo, Cetus, italia, Lisboa, Madalena

4956.0505



Europa Universal

Ref.		€/Un.
4700.0200	PP	<b>11,00 €</b>

Europa, Neoclassic, M. Rosa, Lisboa, Algarve, Alvor, Estaco

4700.0350



Europa M/R

Ref.		€/Un.
4700.0300	PP	<b>11,00 €</b>

Europa, Neoclassic, M. Rosa, Lisboa, Algarve, Alvor, Estaco, Munique

4700.0350



PP Sani-30

Ref.		€/Un.
4770.0000	PP	<b>9,95 €</b>

M. Rosa, Estaco, Lunar, Madalena, Europa, Apolo

4770.0005



André

Ref.		€/Un.
4752.3003	PP	10,00 €

Prestige, Alfa, Aveiro, Estoril, Eros, Rubi

4756.0300



Monte Rosa

Ref.		€/Un.
4750.0300	PP	6,30 €

Europa, M. Rosa, Lisboa, Algarve



Monte Rosa

Ref.		€/Un.
4750.2000	PP	9,00 €

Europa, M. Rosa, Lisboa, Algarve



Monte Bianco

Ref.		€/Un.
4751.0300	PP	9,00 €

M. Bianco



Monte Bianco

Ref.		€/Un.
4751.2000	PP	9,00 €

M. Bianco



ABS Grécia

Ref.		€/Un.
4703.0300	ABS	25,00 €

Grécia

4703.0307 4703.0305



Concord

Ref.		€/Un.
4702.0300	ABS	30,00 €

Concorde, Veneza, Ares

4756.0200 4756.0015



Alfa

Ref.		€/Un.
4706.0300	ABS	26,00 €

Estoril, Alfa, Regina, Condor, Prestige, Sirius

4756.0103 4756.0100



# 1.9

## Ligações Malha de Aço e Sanitárias, Acessórios Cromados

Conexiones Inox y Sanitarias, Accesorios Cromo  
S.S. Flexible Hoses and Sanitary Conections, Chrome Fittings  
Flexibles Inox et Sanitaires, Raccords Chromé

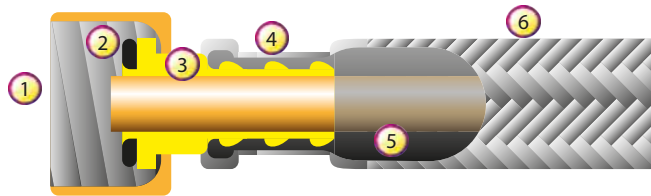

1 - Porca: Latão | 2 - Vedante: EPDM | 3 - Ponteira: Latão | 4 - Casquilho: Inox | 5 - Tubo Int.: EPDM | 6 - Malha: Inox

ES - 1 - Tuerca: Latón | 2 - Junta: EPDM | 3 - Inserto: Latón | 4 - Campana: Inox | 5 - Tubo Interior: EPDM | 6 - Malla: Inox

EN - 1 - Nut: Brass | 2 - Joint: EPDM | 3 - Insert: Brass | 4 - Press Sleeve: Inox | 5 - Inner Tube: Inox | Mesh: Inox

FR - 1 - Écrou: Laiton | 2 - Joint: EPDM | 3 - Jonction: Brass | 4 - Douille: Inox | 5 - Tuyau Interieur: EPDM | 6 - Tresse: Inox

### Guia de Instalação

Guía de Instalación | Installation Guide | Guide de Instalation

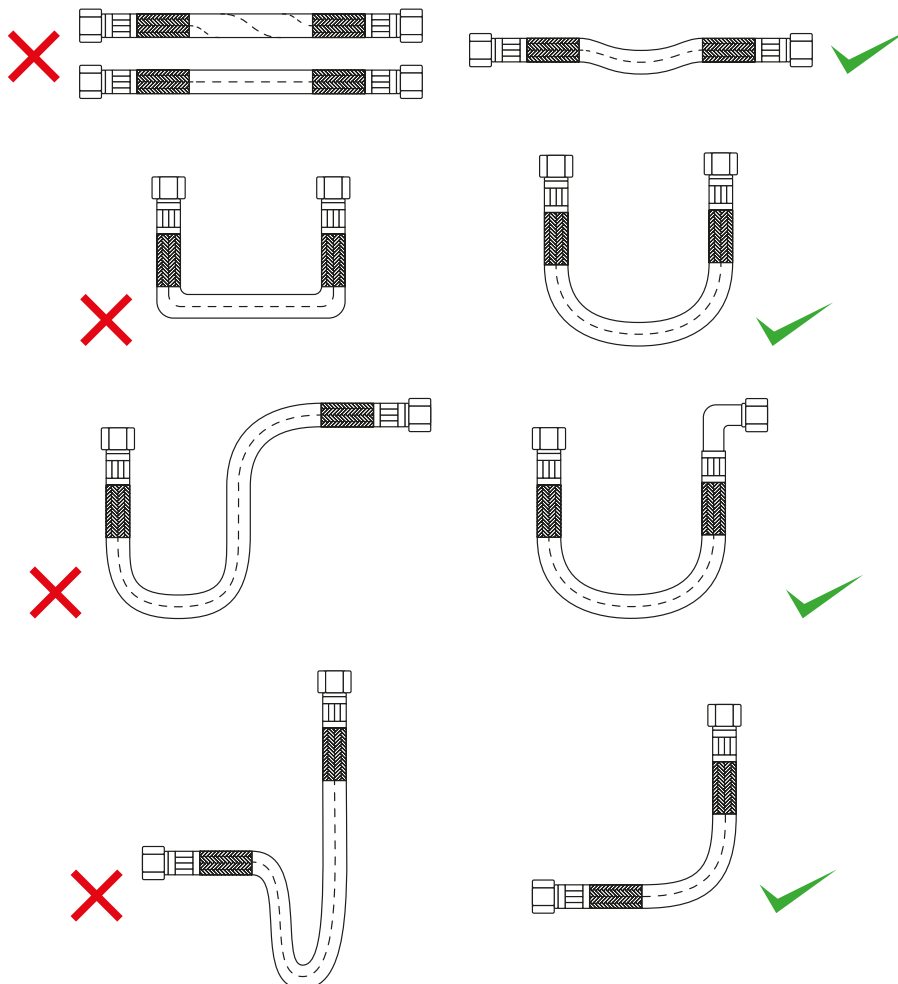

# Ligações Malha de Aço F/F

Conexiones Acero Inox H/H | S.S. Sanitary Conections F/F | Flexibles Sanitaires Inox F/F

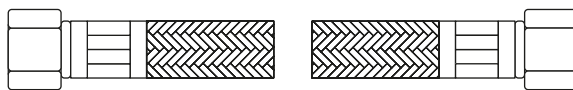

F/F 3/8" DN8  
H/H 3/8" DN8



Ref.		€/Un.		
0101.1010	10 cm	1,60 €	25	100
0101.1015	15 cm	1,62 €	25	100
0101.1020	20 cm	1,64 €	25	100
0101.1025	25 cm	1,72 €	25	100
0101.1030	30 cm	1,76 €	25	100
0101.1035	35 cm	1,86 €	25	100
0101.1040	40 cm	1,95 €	25	100
0101.1045	45 cm	2,09 €	25	100
0101.1050	50 cm	2,23 €	25	100
0101.1060	60 cm	2,35 €	25	100
0101.1070	70 cm	3,12 €	25	100
0101.1080	80 cm	3,36 €	25	100
0101.1100	100 cm	3,82 €	25	100
0101.1125	125 cm	4,50 €	25	100
0101.1150	150 cm	5,09 €	25	100
0101.1175	175 cm	5,67 €	25	100

F/F 1/2" x 3/8" DN8  
H/H 1/2" x 3/8" DN8



Ref.		€/Un.		
0101.2015	15 cm	1,62 €	25	100
0101.2020	20 cm	1,64 €	25	100
0101.2025	25 cm	1,72 €	25	100
0101.2030	30 cm	1,76 €	25	100
0101.2035	35 cm	1,86 €	25	100
0101.2040	40 cm	1,95 €	25	100
0101.2045	45 cm	2,09 €	25	100
0101.2050	50 cm	2,23 €	25	100
0101.2060	60 cm	2,35 €	25	100
0101.2070	70 cm	3,12 €	25	100
0101.2080	80 cm	3,36 €	25	100
0101.2100	100 cm	3,82 €	25	100
0101.2125	125 cm	4,50 €	25	100
0101.2150	150 cm	5,09 €	25	100
0101.2175	175 cm	5,67 €	25	100

F/F 1/2" DN8  
H/H 1/2" DN8



Ref.		€/Un.		
0101.3015	15 cm	1,62 €	25	100
0101.3020	20 cm	1,64 €	25	100
0101.3025	25 cm	1,72 €	25	100
0101.3030	30 cm	1,76 €	25	100
0101.3035	35 cm	1,86 €	25	100
0101.3040	40 cm	1,95 €	25	100
0101.3045	45 cm	2,09 €	25	100
0101.3050	50 cm	2,23 €	25	100
0101.3060	60 cm	2,35 €	25	100
0101.3070	70 cm	3,12 €	25	100
0101.3080	80 cm	3,36 €	25	100
0101.3090	90 cm	3,59 €	25	100
0101.3100	100 cm	3,82 €	25	100
0101.3125	125 cm	4,50 €	25	100
0101.3150	150 cm	5,09 €	25	100
0101.3175	175 cm	5,67 €	25	100
0101.3200	200 cm	6,45 €	25	100

F/F 1/2" x 3/4" DN13  
H/H 1/2" x 3/4" DN13



Ref.		€/Un.		
0101.4015	15 cm	4,46 €	25	100
0101.4020	20 cm	4,57 €	25	100
0101.4025	25 cm	4,69 €	25	100
0101.4030	30 cm	4,85 €	25	100
0101.4035	35 cm	5,02 €	25	100
0101.4040	40 cm	5,28 €	25	100
0101.4045	45 cm	5,53 €	25	100
0101.4050	50 cm	5,98 €	25	100
0101.4060	60 cm	6,54 €	25	100
0101.4100	100 cm	8,20 €	10	40

F/F 1/2" x 1/2" x 3/4" DN13  
H/H 1/2" x 1/2" x 3/4" DN13



Ref.		€/Un.		
0101.6015	15 cm	4,46 €	25	100
0101.6020	20 cm	4,57 €	25	100
0101.6025	25 cm	4,69 €	25	100
0101.6030	30 cm	4,85 €	25	100
0101.6035	35 cm	5,02 €	25	100
0101.6040	40 cm	5,28 €	25	100
0101.6045	45 cm	5,53 €	25	100
0101.6050	50 cm	5,98 €	25	100
0101.6060	60 cm	6,54 €	25	100
0101.6070	70 cm	7,15 €	25	100
0101.6080	80 cm	7,41 €	25	100
0101.6100	100 cm	8,20 €	25	100

F/F 3/4" DN13  
H/H 3/4" DN13



Ref.		€/Un.		
0101.5015	15 cm	4,90 €	25	100
0101.5020	20 cm	5,00 €	25	100
0101.5025	25 cm	5,09 €	25	100
0101.5030	30 cm	5,23 €	25	100
0101.5035	35 cm	5,49 €	25	100
0101.5040	40 cm	5,72 €	25	100
0101.5045	45 cm	5,98 €	25	100
0101.5050	50 cm	6,24 €	25	100
0101.5060	60 cm	6,82 €	25	100
0101.5070	70 cm	7,48 €	25	100
0101.5080	80 cm	8,37 €	25	100
0101.5100	100 cm	9,73 €	25	100
0101.5125	125 cm	10,90 €	25	100
0101.5150	150 cm	12,45 €	25	100
0101.5175	175 cm	14,06 €	25	100
0101.5200	200 cm	15,63 €	25	100

F/F 1" DN25  
H/H 1" DN25



Ref.		€/Un.		
0101.7030	30 cm	14,04 €	25	100
0101.7040	40 cm	15,48 €	25	100
0101.7050	50 cm	16,62 €	25	100
0101.7060	60 cm	18,43 €	25	100
0101.7070	70 cm	19,85 €	25	100
0101.7080	80 cm	21,91 €	25	100
0101.7100	100 cm	25,33 €	25	100

# Ligações Malha de Aço M/F

Conexiones Acero Inox M/H | S.S. Sanitary Conections M/F | Flexibles Sanitaires Inox M/F

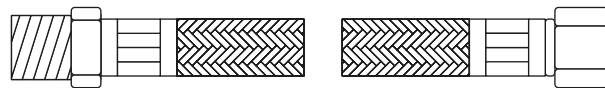

M/F 3/8" DN8  
M/H 3/8" DN8



Ref.	Length	€/Un.	25	100
0102.1010	10 cm	1,60 €	25	100
0102.1015	15 cm	1,62 €	25	100
0102.1020	20 cm	1,64 €	25	100
0102.1025	25 cm	1,72 €	25	100
0102.1030	30 cm	1,76 €	25	100
0102.1035	35 cm	1,86 €	25	100
0102.1040	40 cm	1,95 €	25	100
0102.1045	45 cm	2,09 €	25	100
0102.1050	50 cm	2,23 €	25	100
0102.1060	60 cm	2,35 €	25	100
0102.1070	70 cm	3,12 €	25	100
0102.1080	80 cm	3,36 €	25	100
0102.1100	100 cm	3,82 €	25	100

M/F 1/2" x 3/8" DN8  
M/H 1/2" x 3/8" DN8



Ref.	Length	€/Un.	25	100
0102.2015	15 cm	1,62 €	25	100
0102.2020	20 cm	1,64 €	25	100
0102.2025	25 cm	1,72 €	25	100
0102.2030	30 cm	1,76 €	25	100
0102.2035	35 cm	1,86 €	25	100
0102.2040	40 cm	1,95 €	25	100
0102.2045	45 cm	2,09 €	25	100
0102.2050	50 cm	2,23 €	25	100
0102.2060	60 cm	2,35 €	25	100
0102.2070	70 cm	3,12 €	25	100
0102.2080	80 cm	3,36 €	25	100
0102.2100	100 cm	3,82 €	25	100

M/F 1/2" DN8  
M/H 1/2" DN8



Ref.	Length	€/Un.	25	100
0102.3015	15 cm	1,62 €	25	100
0102.3020	20 cm	1,64 €	25	100
0102.3025	25 cm	1,72 €	25	100
0102.3030	30 cm	1,76 €	25	100
0102.3035	35 cm	1,86 €	25	100
0102.3040	40 cm	1,95 €	25	100
0102.3045	45 cm	2,09 €	25	100
0102.3050	50 cm	2,23 €	25	100
0102.3060	60 cm	2,35 €	25	100
0102.3070	70 cm	3,12 €	25	100
0102.3080	80 cm	3,36 €	25	100
0102.3100	100 cm	3,82 €	25	100
0102.3125	125 cm	4,50 €	25	100
0102.3150	150 cm	5,09 €	25	100
0102.3175	175 cm	5,67 €	25	100
0102.3200	200 cm	6,45 €	25	100

M/F 1/2" x 3/4" DN13  
M/H 1/2" x 3/4" DN13



Ref.	Length	€/Un.	25	100
0102.4020	20 cm	4,57 €	25	100
0102.4025	25 cm	4,69 €	25	100
0102.4030	30 cm	4,85 €	25	100
0102.4035	35 cm	5,02 €	25	100
0102.4040	40 cm	5,28 €	25	100
0102.4045	45 cm	5,53 €	25	100
0102.4050	50 cm	5,98 €	25	100

M/F 1/2" x 1/2" x 3/4" DN13  
M/H 1/2" x 1/2" x 3/4" DN13



Ref.	Length	€/Un.	25	100
0102.4315	15 cm	4,46 €	25	100
0102.4320	20 cm	4,57 €	25	100
0102.4325	25 cm	4,69 €	25	100
0102.4330	30 cm	4,85 €	25	100
0102.4335	35 cm	5,02 €	25	100
0102.4340	40 cm	5,28 €	25	100
0102.4345	45 cm	5,53 €	25	100
0102.4350	50 cm	5,98 €	25	100

M/F 3/4" DN13  
M/H 3/4" DN13



Ref.	Length	€/Un.	25	100
0102.5015	15 cm	4,90 €	25	100
0102.5020	20 cm	5,00 €	25	100
0102.5025	25 cm	5,09 €	25	100
0102.5030	30 cm	5,23 €	25	100
0102.5035	35 cm	5,49 €	25	100
0102.5040	40 cm	5,72 €	25	100
0102.5045	45 cm	5,98 €	25	100
0102.5050	50 cm	6,24 €	25	100
0102.5060	60 cm	6,82 €	25	100

M/F 1" DN25  
M/H 1" DN25



Ref.	Length	€/Un.	25	100
0102.5530	30 cm	14,04 €	25	100
0102.5540	40 cm	15,48 €	25	100
0102.5550	50 cm	16,62 €	25	100
0102.5560	60 cm	18,43 €	25	100
0102.5570	70 cm	19,85 €	25	100
0102.5580	80 cm	21,91 €	25	100
0102.5600	100 cm	25,33 €	25	100



p/ Monobloco p/ Monobloc  
f/ Double Handle p/ Melangeur

M 1/10 F 3/8" DN8  
M 1/10 H 3/8" DN8



Ref.	Length	€/Un.	25	100
0105.1235	35 cm	2,77 €	25	100

# Ligações Malha de Aço

Conexiones Acero Inox | S.S. Sanitary Conections | Flexibles Sanitaires Inox

Bicone  
Compression

Compresión  
Compression



F/F 3/8" Bicone  
H/H 3/8" DN8



Ref.	Length	€/Un.	Bag	Box
0114.1015	15 cm	2,70 €	25	100
0114.1020	20 cm	2,77 €	25	100
0114.1025	25 cm	2,95 €	25	100
0114.1030	30 cm	3,04 €	25	100
0114.1035	35 cm	3,20 €	25	100
0114.1040	40 cm	3,30 €	25	100
0114.1045	45 cm	3,12 €	25	100
0114.1050	50 cm	3,55 €	25	100

F/F 1/2" Bicone  
H/H 1/2" Bicone

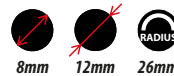

Ref.	Length	€/Un.	Bag	Box
0114.1115	15 cm	2,70 €	25	100
0114.1120	20 cm	2,77 €	25	100
0114.1125	25 cm	2,95 €	25	100
0114.1130	30 cm	3,04 €	25	100
0114.1135	35 cm	3,20 €	25	100
0114.1140	40 cm	3,30 €	25	100
0114.1145	45 cm	3,12 €	25	100
0114.1150	50 cm	3,31 €	25	100

p/ Monobloco p/ Monobloc  
f/ Double Handle p/ Mélangeur

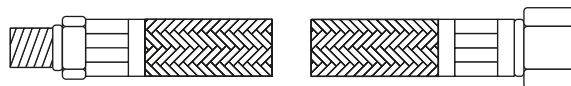

M 1/10 F 3/8" DN8  
M 1/10 H 3/8" DN8

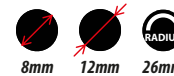

Ref.	Length	€/Un.	Bag	Box
0105.1030	30 cm	1,58 €	25	100
0105.1035	35 cm	1,63 €	25	100
0105.1040	40 cm	1,83 €	25	100
0105.1045	45 cm	2,15 €	25	100
0105.1050	50 cm	2,29 €	25	100
0105.1060	60 cm	2,86 €	25	100
0105.1070	70 cm	3,34 €	25	100
0105.1080	80 cm	3,48 €	25	100
0105.1100	100 cm	4,10 €	25	100

Bicone  
Compression

Compresión  
Compression



M/M 3/8" DN8  
M/M 3/8" DN8



Ref.	Length	€/Un.	Bag	Box
0114.1515	15 cm	2,70 €	25	100
0114.1520	20 cm	2,77 €	25	100
0114.1525	25 cm	2,95 €	25	100
0114.1530	30 cm	3,04 €	25	100
0114.1535	35 cm	3,20 €	25	100
0114.1540	40 cm	3,30 €	25	100

M/M 1/2" DN8  
M/M 1/2" DN8



Ref.	Length	€/Un.	Bag	Box
0114.1615	15 cm	2,70 €	25	100
0114.1620	20 cm	2,77 €	25	100
0114.1625	25 cm	2,95 €	25	100
0114.1630	30 cm	3,04 €	25	100
0114.1635	35 cm	3,20 €	25	100
0114.1640	40 cm	3,30 €	25	100

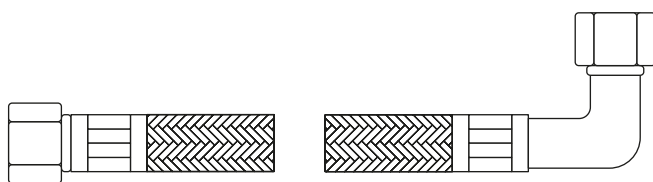

Curva 3/4" F 1/2" DN13  
Codo 3/4" H 1/2" DN13



Ref.	Length	€/Un.	Bag	Box
0103.3020	20 cm	6,52 €	25	100
0103.3025	25 cm	7,17 €	25	100
0103.3030	30 cm	7,50 €	25	100
0103.3035	35 cm	7,79 €	25	100
0103.3040	40 cm	8,01 €	25	100
0103.3050	50 cm	8,69 €	25	100
0103.3060	60 cm	9,18 €	25	100

Curva 3/4" F 3/4" DN13  
Curva 3/4" H 3/4" DN13



Ref.	Length	€/Un.	Bag	Box
0103.4025	25 cm	7,60 €	25	100
0103.4030	30 cm	7,85 €	25	100
0103.4035	35 cm	8,01 €	25	100
0103.4040	40 cm	8,34 €	25	100
0103.4050	50 cm	9,02 €	25	100
0103.4060	60 cm	9,53 €	25	100



# Ligações Sanitárias

Conexiones Sanitarias | Sanitary Conections | Flexibles Sanitaires



110R

Ligação Flexível Retrátil 1/2"

Flexo Ducha Extraíble 1/2"

Pull-Out Flexible Hose 1/2"

Flexible de Douche p/ Mitigeur 1/2"

S.S.

Ref.		€/Un.		
0110.3125	1,25 m	6,54 €	1	10
0110.3150	1,5 m	7,29 €	1	10



4099

Ligação Extensível Inox 1/2"

Flexo de Ducha Extensible 1/2"

Extensible Flexible Hose 1/2"

Flexible de Douche Extensible 1/2"

Ref.		€/Un.			
4099.0175	1,70 m - 2,25 m	3,80 €	1	50	150



110G

Ligação Flexível c/ Cone 1/2"

Flexo de Ducha c/ Cónico 1/2"

Flexible Hose Conic Nut 1/2"

Flexible de Douche e/ Conique 1/2"

Ref.		€/Un.		
0110.1125	1,25 m	6,22 €	1	50
0110.1150	1,5 m	6,73 €	1	50
0110.1175	1,75 m	7,46 €	1	50
0110.1200	2 m	8,33 €	1	50



109

Ligação Flexível 1/2"

Flexo de Ducha 1/2"

Flexible Hose 1/2"

Flexible de Douche 1/2"

Ref.		€/Un.		
0109.1125	1,25 m	5,61 €	1	50
0109.1150	1,5 m	6,17 €	1	50
0109.1175	1,75 m	6,95 €	1	50
0109.1200	2 m	8,14 €	1	50

# Ligações Sanitárias

Conexiones Sanitárias | Sanitary Conections | Flexibles Sanitaires



**126T**  
**Tubo Corrugado Inox - 10m**  
 Corrugated Pipe - 10 m  
 Tubo Corrugado Inox - 10 m  
 Tuyau Ondulé - 10 m

Ref.		€/m		
0126.0002	3/8"	<b>6,77 €</b>	10	50
0126.0003	1/2"	<b>8,85 €</b>	10	50
0126.0004	3/4"	<b>10,94 €</b>	10	50
0126.0005	1"	<b>16,67 €</b>	10	50



**138C**  
**Fêmea p/ Tubo Corrugado**  
 Tuerca p/ Tubo Corrugado  
 Nut f/ Corrugated Pipe  
 Écrou p/ Tuyau Ondulé

Ref.		€/Un.		
0138.5002	3/8"	<b>0,65 €</b>	10	100
0138.5003	1/2"	<b>0,85 €</b>	10	100
0138.5004	3/4"	<b>1,14 €</b>	10	100
0138.5005	1"	<b>2,14 €</b>	10	100
0138.5012	1/2" x 3/8"	<b>0,98 €</b>	10	100
0138.5014	3/4" x 1/2"	<b>1,29 €</b>	10	100



**126K**  
**Kit Montagem Tubo Corrugado**  
 Kit Montaje Tubo Corrugado  
 Corrugated Pipe Installation Kit  
 Kit d'Installation p/ Tuyau Ondulé

Ref.	€/Un.	
0126.1001	<b>229,17 €</b>	5



**214**  
**Tubo de Cobre - 25 m**  
 Tubo de Cobre - 25 m  
 Copper Pipe - 25 m  
 Tube de Cuivre - 25 m

Ref.		€/m		
0214.0111	10 mm	<b>11,00 €</b>	25	100
0214.0112	12 mm	<b>12,00 €</b>	25	100



**120L**  
**Ligação Máquina de Lavar**  
 Conexión p/ Lavadora  
 Washing Machine Hose  
 Tuyau p/ Machine à Laver

Ref.		€/Un.		
0120.1125	1,25 m	<b>3,20 €</b>	1	50
0120.1150	1,5 m	<b>3,50 €</b>	1	50
0120.1175	1,75 m	<b>3,80 €</b>	1	50
0120.1200	2 m	<b>4,50 €</b>	1	50
0120.1250	2,5 m	<b>5,10 €</b>	1	50
0120.1300	3 m	<b>6,00 €</b>	1	50



**120D**  
**Ligação Descarga Máquina Lavar**  
 Tubo Descarga Lavadora  
 Washing Machine Outlet Hose  
 Flexible de Vidange e/ Machine à Laver

Ref.		€/Un.		
0120.3150	1,5 m	<b>3,20 €</b>	1	50
0120.3200	2 m	<b>3,95 €</b>	1	50

# Acessórios Latão Cromados

Accesorios Latón Cromo | Chrome Brass Fittings | Raccords en Laiton Chromé



**130A**  
Casquilho 1/2" x 3/8"  
Machón 1/2" x 3/8"  
Hexagonal Nipple 1/2" x 3/8"  
Mamelon Réduit 1/2" x 3/8"

Cr

Ref.		€/Un.		
0130.0102	20 mm	<b>1,10 €</b>	10	180
0130.0103	30 mm	<b>1,39 €</b>	10	100
0130.0104	40 mm	<b>1,75 €</b>	10	90



**130B**  
Casquilho 1/2" x 1/2"  
Machón 1/2" x 1/2"  
Hexagonal Nipple 1/2" x 1/2"  
Mamelon 1/2" x 1/2"

Cr

Ref.		€/Un.		
0130.1102	20 mm	<b>1,10 €</b>	10	180
0130.1103	30 mm	<b>1,39 €</b>	10	100
0130.1104	40 mm	<b>1,75 €</b>	10	90



**130C**  
Casquilho 3/4" x 1/2"  
Machón 3/4" x 1/2"  
Hexagonal Nipple 3/4" x 1/2"  
Mamelon Réduit 3/4" x 1/2"

Cr

Ref.		€/Un.		
0130.6003	23 mm	<b>2,21 €</b>	10	100



**130D**  
Casquilho 3/4" x 3/4"  
Machón 3/4" x 3/4"  
Hexagonal Nipple 3/4" x 3/4"  
Mamelon Réduit 3/4" x 3/4"

Cr

Ref.		€/Un.		
0130.6004	23 mm	<b>2,21 €</b>	10	100
0130.9001	40 mm	<b>3,35 €</b>	10	100



**131**  
Casquilho M/M CV  
Machón CV  
Hexagonal Nipple CV  
Mamelon CV

Cr

Ref.		€/Un.		
0131.0101	1/4"	<b>0,64 €</b>	10	100
0131.0102	3/8"	<b>0,78 €</b>	10	100
0131.0103	1/2"	<b>1,10 €</b>	10	100
0131.0104	3/4"	<b>1,60 €</b>	10	100
0131.0112	3/8" x 1/4"	<b>1,04 €</b>	10	100
0131.0113	1/2" x 1/4"	<b>1,04 €</b>	10	100
0131.0114	1/2" x 3/8"	<b>1,10 €</b>	10	100
0131.0115	3/4" x 1/2"	<b>1,54 €</b>	10	100



**132**  
Casquilho M/F CV  
Reducción Hexagonal M/H CV  
Hexagonal Reduction M/F CV  
Reduction Hexagonal M/F CV

Cr

Ref.		€/Un.		
0132.0111	3/8" x 1/4"	<b>0,56 €</b>	10	100
0132.0112	1/2" x 1/4"	<b>0,70 €</b>	10	100



**133**  
Aumento Sextavado M/F  
Aumento Hexagonal M/H  
Hexagonal Nut M/F  
Écrou Hexagonale M/F

Cr

Ref.		€/Un.		
0133.1103	1/2" x 3/8"	<b>0,75 €</b>	10	250
0133.1104	3/4" x 1/2"	<b>1,30 €</b>	10	180



**138F**  
Fêmea  
Tuerca  
Nut  
Écrou

Cr

Ref.		€/Un.		
0138.0102	3/8"	<b>0,55 €</b>	10	100
0138.0103	1/2"	<b>0,66 €</b>	10	100
0138.0104	3/4"	<b>1,12 €</b>	10	100
0138.0113	1/2" x 3/8"	<b>0,68 €</b>	10	100

# Acessórios Latão Cromados

Accesórios Latón Cromo | Chrome Brass Fittings | Raccords en Laiton Chromé



140B

Aumento cilíndrico 1/2" (Ø26)

Alargadera Cilíndrica 1/2" (Ø26)

Cylindrical Extension 1/2" (Ø26)

Rallonge Cylindrique 1/2" (Ø26)



Ref.		€/Un.		
0140.1001	10 mm	<b>0,99 €</b>	10	100
0140.1002	15 mm	<b>1,12 €</b>	10	100
0140.1003	20 mm	<b>1,33 €</b>	10	100
0140.1004	25 mm	<b>1,55 €</b>	10	100
0140.1005	30 mm	<b>1,76 €</b>	10	100
0140.1006	50 mm	<b>2,74 €</b>	10	50
0140.1007	80 mm	<b>4,15 €</b>	10	50
0140.1008	100 mm	<b>5,13 €</b>	10	25



140C

Aumento cilíndrico 1/2" (Ø27)

Alargadera Cilíndrica 1/2" (Ø27)

Cylindrical Extension 1/2" (Ø27)

Rallonge Cylindrique 1/2" (Ø27)



Ref.		€/Un.		
0140.1401	10 mm	<b>1,09 €</b>	10	100
0140.1402	15 mm	<b>1,31 €</b>	10	100
0140.1403	20 mm	<b>1,54 €</b>	10	100
0140.1404	25 mm	<b>1,79 €</b>	10	100
0140.1405	30 mm	<b>2,09 €</b>	10	100
0140.1406	50 mm	<b>3,22 €</b>	10	50
0140.1407	80 mm	<b>4,83 €</b>	10	50
0140.1408	100 mm	<b>5,54 €</b>	10	25



140D

Aumento cilíndrico 3/4"

Alargadera Cilíndrica 3/4"

Cylindrical Extension 3/4"

Rallonge Cylindrique 3/4"



Ref.		€/Un.		
0140.1101	10 mm	<b>1,62 €</b>	10	30
0140.1102	15 mm	<b>1,80 €</b>	10	30
0140.1103	20 mm	<b>2,06 €</b>	10	30
0140.1104	25 mm	<b>2,27 €</b>	10	30
0140.1105	30 mm	<b>2,58 €</b>	10	30
0140.1106	50 mm	<b>3,77 €</b>	10	30
0140.1107	80 mm	<b>5,36 €</b>	10	20
0140.1108	100 mm	<b>6,50 €</b>	10	20



136T

Tè 1/2"

Te 1/2"

Tee 1/2"

Tè 1/2"



Ref.		€/Un.		
0136.2111	MxFxF	<b>3,94 €</b>	10	50
0136.2113	FxMxM	<b>4,08 €</b>	10	50
0136.2115	FxFxF	<b>3,76 €</b>	10	50
0136.2117	FxMxF	<b>4,01 €</b>	10	50
0136.2119	MxFxM	<b>4,88 €</b>	10	50
0136.2121	MxMxM	<b>4,88 €</b>	10	50



136M

Curva M/M

Curva M/M

Bend M/M

Courbe M/M



Ref.		€/Un.		
0136.0100	1/2" x 3/8"	<b>2,90 €</b>	10	90
0136.1100	1/2" x 1/2"	<b>2,90 €</b>	10	90
0136.1105	3/4" x 3/4"	<b>4,75 €</b>	10	50
0136.1110	1/2" x 3/4"	<b>3,57 €</b>	10	50



136F

Curva F/F

Curva H/H

Bend F/F

Courbe F/F



Ref.		€/Un.		
0136.1900	1/2" x 3/8"	<b>3,20 €</b>	10	100
0136.2000	1/2"	<b>3,46 €</b>	10	100



136P

Curva c/ Porca Louca

Curva c/ Racor Loco

Bend w/ Loose Nut

Courbe a/ Écrou Tournant



Ref.		€/Un.		
0136.1800	1/2" x 3/4"	<b>3,46 €</b>	10	50



136MF

Curva M/F

Curva M/H

Bend M/F

Courbe M/F



Ref.		€/Un.		
0136.2001	1/2" x 3/8"	<b>3,46 €</b>	10	50
0136.2011	1/2" x 1/2"	<b>3,46 €</b>	10	50



# Acessórios Cromados

Accesórios Cromo | Chrome Fittings | Raccords Chromé



**140T**  
Tubo p/ Radiador  
Tubo p/ Radiador  
Radiator Connection Pipe  
Tuyau p/Conexion de Radiateur



Ref.		€/Un.		
0140.2001	12 mm x 1/2"	2,02 €	40	200
0140.2002	14 mm x 1/2"	2,24 €	40	200
0140.2003	15 mm x 1/2"	2,05 €	40	200



**136J**  
Joelho 1/2"  
Codo 1/2"  
Elbow 1/2"  
Coude 1/2"



Ref.		€/Un.		
0136.2301	FxF	3,34 €	10	100
0136.2303	MxM	3,71 €	10	100
0136.2305	MxF	3,40 €	10	100



**142A**  
Espelho p/ Tubo Radiador Ø63 mm  
Florón p/ Tubo Radiador Ø63 mm  
Rosette f/ Radiator Pipe Ø63 mm  
Rosace p/ Tuyau de Radiateur Ø63 mm



Ref.		€/Un.		
0142.0112	12 mm	0,53 €	10	100
0142.0114	14 mm	0,58 €	10	100
0142.0115	15 mm	0,53 €	10	100



**140B**  
Espelho Ø55 mm  
Florón Ø55 mm  
Rosette Ø55 mm  
Rosace Ø55 mm



Ref.		€/Un.		
0142.0102	3/8"	0,20 €	10	100
0142.0103	1/2"	0,20 €	10	100
0142.0104	3/4"	0,21 €	10	100



**142C**  
Espelho Largo Ø63 mm  
Florón Ancho Ø63 mm  
Wide Rosette Ø63 mm  
Rosace Large Ø63 mm



Ref.		€/Un.		
0142.0113	1/2"	0,27 €	10	100
0142.0107	3/4"	0,27 €	10	100



**140TP**  
Taco pré instalação aquecimento  
Tapón pré.instación calefacción  
Pre-installation plug f/ heating  
Bouchon de pré-installation p/ chauffage



Ref.		€/Un.		
0140.2050	1/2"	1,59 €	10	100



**140TL**  
Taco pré instalação aquecimento  
Tapón pré.instación calefacción  
Pre-installation plug f/ heating  
Bouchon de pré-installation p/ chauffage



Ref.		€/Un.		
0140.2033	1/2"	3,80 €	10	50

Espelho latão  
Florón latón  
Brass rosette  
Rosace laiton



# 2

## Gestão de Água

Gestión del Agua | Water Management | Gestion de L'eau

	Acabamento   Revestimiento   Coating   Finition		Filtro   Filtro   Filter   Filtre
	Material   Material   Material   Matériel		Mola   Resorte   Spring   Ressort
	Latão   Latón   Brass   Laiton		Vedação   Junta   Washer   Joint
	Aço Zincado   Acero Galvanizado Galvanized Steel   Acier Galvanisé		1/4 de Volta   1/4 de Vuelta   1/4 Turning   1/4 Tour
	Plástico   Plástico   Plastic   Plastique		Campo Regulação   Campo Regulación Control Range   Plage de Réglage
	Temperatura Máxima   Temperatura Máxima Maximum Temperature   Température Maxime		Unidades p/ Saco   Unidades p/ Bolsa Units each Bag   Unités p/ sac
	Pressão / Pressão Máxima   Presión / Presión Máxima Pressure / Maximum Pressure   Pression / Pression Maxime		Contacte-nos   Contáctenos   Contact us   Contactez-nous
	Aquecimento   Calefacción   Heating   Chauffage		Aço   Acero   Steel   Acier
	Para Uso Doméstico   Uso Domestico Domestic Use   Usage Domestique		
	Uso Agrícola   Uso Agrícola Agricultural Use   Usage Agricole		
	Rega e Jardim   Rego y Jardín Irrigation and Garden   Arrosage et Jardin		
	Uso Industrial   Uso Industrial Industrial Use   Usage Industriel		
	Manípulo   Manípulo   Handle   Manipule		
	Anti-Gelo   Anti-Hielo   Anti-Frost   Anti-Givre		
	Medida/Cor   Medida/Color Size/Colour   Mesure/Couleur		
			Cromado/Inox/Branco   Cromo/Inox/Blanco Chrome/S. S./White   Chrome/Inox/Blanc



# 2.0

## Válvulas e Torneiras

Válvulas y Grifos | Valves and Bibcocks | Vannes et Robinets

**mew**  
products

**Aplicações** Aplicaciones / Applications / Application



**Latão**

Latón

Brass

Laiton

**Rosca Paralela ISO228/1**

Rosca Paralela ISO228/1

Parallel Thread ISO228/1

Filetage Parallèle ISO228/1



70 °C

100 °C

120 °C



# Válvulas e Torneiras

Válvulas y Grifos | Valves and Bibcocks | Vannes et Robinets



TT300  
Passador Esfera F/F  
Válvula Esfera H/H  
Ball Valve F/F  
Vanne à Sphère F/F



Ref.		€/Un.		
6000.0101	1/4	2,50 €	18	180
6000.0102	3/8	2,50 €	12	120
6000.0103	1/2	2,88 €	12	120
6000.0104	3/4	3,69 €	8	80
6000.0105	1	5,70 €	6	60
6000.0106	1 1/4	9,40 €	4	40
6000.0107	1 1/2	13,70 €	2	20
6000.0108	2	25,00 €	2	16
6000.0109	2 1/2	59,00 €	2	8
6000.0110	3	85,11 €	2	6
6000.0111	4	142,55 €	1	3



Manipulo Inox

TT300I  
Passador Esfera F/F  
Válvula Esfera H/H  
Ball Valve F/F  
Vanne à Sphère F/F

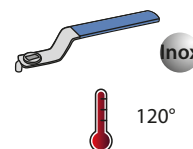

Ref.		€/Un.		
6000.0203	1/2	3,72 €	12	120
6000.0204	3/4	5,32 €	8	80
6000.0205	1	9,04 €	6	60
6000.0206	1 1/4	14,68 €	4	40
6000.0207	1 1/2	21,28 €	2	20
6000.0208	2	31,38 €	2	16
6000.0209	2 1/2	60,64 €	2	8
6000.0210	3	90,43 €	2	6



TT600  
Passador Esfera M/F  
Válvula Esfera M/H  
Ball Valve M/F  
Vanne à Sphère M/F



Ref.		€/Un.		
6000.0113	1/2	3,00 €	12	120
6000.0114	3/4	3,98 €	8	80
6000.0115	1	6,00 €	6	60
6000.0116	1 1/4	10,63 €	4	40
6000.0117	1 1/2	14,34 €	2	20
6000.0118	2	28,00 €	2	16



Manipulo Inox

TT600I  
Passador Esfera M/F  
Válvula Esfera M/H  
Ball Valve M/F  
Vanne à Sphère M/F

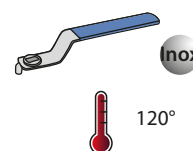

Ref.		€/Un.		
6000.0223	1/2	3,80 €	12	120
6000.0224	3/4	5,85 €	8	80
6000.0225	1	9,04 €	6	60
6000.0226	1 1/4	15,96 €	4	40
6000.0227	1 1/2	21,28 €	2	20
6000.0228	2	32,98 €	2	16



# Válvulas e Torneiras

Válvulas y Grifos | Valves and Bibcocks | Vannes et Robinets



TT301

Passador Esfera Borboleta F/F

Válvula Esfera Mariposa H/H

Butterfly Ball Valve F/F

Vanne à Sphère Pampillon F/F



Ref.		€/Un.		
6001.0103	1/2	2,89 €	15	100
6001.0104	3/4	3,65 €	10	100
6001.0105	1	5,90 €	6	60



TT3002

Passador Esfera Borboleta M/F

Válvula Esfera Mariposa M/H

Butterfly Ball Valve M/F

Vanne à Sphère Pampillon M/F



Ref.		€/Un.		
6002.0103	1/2	2,98 €	10	100
6002.0104	3/4	4,00 €	10	100
6002.0105	1	6,15 €	6	60



Torneira Esfera c/ Junção Eco

Grifo Esfera Jardín Eco

Hose Bibcock Eco

Robinet d'Arrêt Eco



Ref.		€/Un.		
6007.0253	1/2x3/4	3,16 €	72	144
6007.0254	3/4x1	4,37 €	54	108
6007.0255	1x1 1/4	7,00 €	36	72



Torneira Esfera c/ Junção Eco

Grifo Esfera Jardín Eco

Hose Bibcock Eco

Robinet d'Arrêt Eco

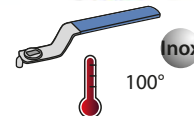

Ref.		€/Un.		
6007.0263	1/2x3/4	3,75 €	8	72
6007.0264	3/4x1	5,20 €	6	54
6007.0265	1x1 1/4	7,80 €	4	36



TT307

Torneira Esfera c/ Junção

Grifo Esfera Jardín

Hose Bibcock

Robinet d'Arrêt



Ref.		€/Un.		
6007.0103	1/2x3/4	4,50 €	10	100
6007.0104	3/4x1	6,00 €	6	60
6007.0105	1x1 1/4	9,40 €	4	40



TT3071

Torneira Esfera c/ Junção

Grifo Esfera Jardín

Hose Bibcock

Robinet d'Arrêt

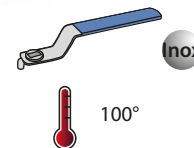

Ref.		€/Un.		
6007.0113	1/2x3/4	5,00 €	10	100
6007.0114	3/4x1	6,60 €	6	60
6007.0115	1x1 1/4	12,00 €	4	40

# Válvulas e Torneiras

Válvulas y Grifos | Valves and Bibcocks | Vannes et Robinets



**TT307A**  
Torneira Esfera c/ Junção Rápida  
Grifo Esfera Jardín Racor Rápido  
Hose Bibcock Quick Connector  
Robinet d'Arrêt



Ref.		€/Un.		
6007.0203	1/2x3/4	<b>5,50 €</b>	10	100
6007.0204	3/4x1	<b>7,50 €</b>	6	60
6007.0205	1x1 1/4	<b>12,77 €</b>	4	40



**TT307D**  
Torneira DuplaEsfera c/ Junção  
Grifo Esfera Jardín Doble  
Double Hose Bibcock  
Robinet d'Arrêt Double

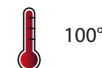

Ref.		€/Un.		
6007.0303	1/2x3/4	<b>9,00 €</b>	4	40



**TT307C**  
Torneira Esfera Cadeado  
Grifo Esfera Candado  
Lockable Hose Bibcock  
Robinet Verrouillable



Ref.		€/Un.		
6007.0403	1/2x3/4	<b>6,50 €</b>	8	80
6007.0404	3/4x1	<b>9,00 €</b>	4	40



**TT303**  
Passador Esfera Bicone  
Válvula Esfera Bicono  
Ball Passer Bicone  
Vanne à Sphère Bicône

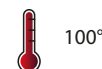

Ref.		€/Un.		
6023.0104	15	<b>6,38 €</b>	15	150
6023.0105	18	<b>7,98 €</b>	10	100
6023.0106	22	<b>11,17 €</b>	6	80
0323.0108	28	<b>15,00 €</b>	-	-



**TT303**  
Passador Esfera Selar  
Válvula Esfera Cuadradillo  
Square Cap Ball Valve  
Vanne à Sphère Capuchon Carré



Ref.		€/Un.		
6003.0103	1/2	<b>3,00 €</b>	12	120
6003.0104	3/4	<b>5,40 €</b>	8	80
6003.0105	1	<b>8,50 €</b>	6	60
6003.0106	1 1/4	<b>20,00 €</b>	4	16
6003.0107	1 1/2	<b>30,00 €</b>	3	12
6003.0108	2	<b>50,00 €</b>	2	8



**TT326**  
Passador Esfera c/ Porca  
Válvula Esfera c/ Tuerca  
Ball Valve w/ Nut  
Vanne à Sphère a/ Écrou

Manipulo Inox

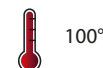
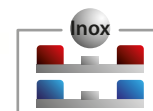

Ref.			€/Un.	
6026.0003	1/2		<b>4,00 €</b>	12
6026.0004	3/4		<b>6,70 €</b>	8
6026.0005	1		<b>10,50 €</b>	5
6026.0023	1/2		<b>4,00 €</b>	12
6026.0024	3/4		<b>6,70 €</b>	8
6026.0025	1		<b>10,50 €</b>	5

# Válvulas e Torneiras

Válvulas y Grifos | Valves and Bibcocks | Vannes et Robinets



**TT310**  
Torneira Esquadria Corte  
Válvula Escuadra  
Angle Valve  
Robinet Équerre



Ref.		€/Un.		
6010.0202	1/2x3/8	<b>1,90 €</b>	100	300
6010.0203	1/2x1/2	<b>2,00 €</b>	100	300
6010.0204	1/2x3/4	<b>2,10 €</b>	100	200



**TT309**  
Torneira Esfera c/ Filtro  
Válvula Escuadra c/ Filtro  
Angle Valve w/ Filter  
Robinet Sous-Lavabo a/ Filtre

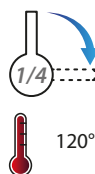

Ref.		€/Un.		
6009.0102	1/2x3/8	<b>2,45 €</b>	100	300
6009.0103	1/2x1/2	<b>2,60 €</b>	100	300
6009.0104	1/2x3/4	<b>3,00 €</b>	100	200



**TT312L**  
Torneira Esfera Máquina Lavar  
Válvula Esfera Lavadora  
Washing Machine Valve  
Robinet Machine à Laver



Ref.		€/Un.		
6010.0103	1/2x1/2	<b>3,20 €</b>	100	200
6010.0104	1/2x3/4	<b>3,20 €</b>	100	200



**TT121**  
Torneira Esquadria PRESTIGE  
Válvula Escuadra PRESTIGE  
Angle Valve PRESTIGE  
Robinet Équerre PRESTIGE



Ref.		€/Un.	
1214.0102	1/2x3/8	<b>15,00 €</b>	1
1214.0103	1/2x1/2	<b>15,50 €</b>	1
1214.0104	1/2x3/4	<b>17,00 €</b>	1



**TT308**  
Torneira Esquadria Quadrada  
Válvula Escuadra Cuadrada  
Square Angle Valve  
Robinet Équerre Carré



Ref.		€/Un.		
6012.0302	1/2x3/8	<b>9,57 €</b>	1	100
6012.0303	1/2x1/2	<b>9,57 €</b>	1	100



**TT101**  
Torneira Esquadria Cilíndrica  
Válvula Escuadra Cilíndrica  
Cilindric Angle Valve  
Robinet Équerre Cylindrique



Ref.		€/Un.		
6012.0202	1/2x3/8	<b>6,38 €</b>	1	100
6012.0203	1/2x1/2	<b>6,38 €</b>	1	100



**TT391D**  
Torneira Dupla Máquina Lavar  
Válvula Doble Lavadora  
Double Washing Machine  
Robinet Machine à Laver Double



Ref.		€/Un.		
6012.0500	1/2x3/4x3/4	<b>12,77 €</b>	5	50



**TT102**  
Torneira Esfera Barril  
Grifo Esfera Barril  
Tank Bibcock  
Robinet



Ref.		€/Un.		
6008.0002	3/8	<b>4,84 €</b>	18	180
6008.0003	1/2	<b>4,84 €</b>	18	180



Torneira Esquadria Dupla  
Válvula Escuadra PRESTIGE  
Angle Valve PRESTIGE  
Robinet Équerre PRESTIGE



Ref.		€/Un.		
6012.0600	1/2x1/2x1/2	9,98 €	1	50



TT391  
Torneira Esquadria Dupla 360°  
Válvula Escuadra Doble 360°  
Double Angle Valve 360°  
Robinet Double 360°



Ref.		€/Un.		
6012.0400	1/2x3/4x3/4	16,80 €	1	50



TT105M  
Torneira Esquadria Mista  
Válvula Escuadra Mixta  
Mixed Angle Valve  
Robinet Équerre Mixte



Ref.		€/Un.		
6012.0450	1/2x3/8x3/4	6,85 €	1	50
6012.0451	1/2x1/2x3/8	7,50 €	1	50



TT320F  
Torneira Economizadora F/F  
Válvula Esfera Mini H/H  
Mini Ball Valve F/F  
Mini-Vanne F/F



Ref.		€/Un.		
6020.0002	3/8	2,72 €	20	200
6020.0003	1/2	2,94 €	20	200



TT320M  
Torneira Economizadora M/F  
Válvula Esfera Mini M/H  
Mini Ball Valve M/F  
Mini-Vanne M/F



Ref.		€/Un.		
6020.0012	3/8	2,72 €	20	200
6020.0013	1/2	2,94 €	20	200



# Válvulas Retenção

Válvulas Retención / Check Valves / Non Retour Vannes



## TT304

Passador Adufa  
Válvula Compuerta  
Gate Valve  
Robinet-Vanne



Ref.		L	M	A	PN	€/Un.		
6004.0103	1/2	38	64,5	50	10	<b>3,87 €</b>	20	120
6004.0104	3/4	41	65	50	10	<b>4,22 €</b>	20	80
6004.0105	1	44,5	76	59	10	<b>5,67 €</b>	15	60
6004.0106	1 1/4	50,5	89	59	10	<b>10,50 €</b>	10	40
6004.0107	1 1/2	51	96,5	70	10	<b>13,50 €</b>	12	48
6004.0108	2	60	120	70	10	<b>20,00 €</b>	3	12
6004.0109	2 1/2	60	156	98	16	<b>44,68 €</b>	1	10
6004.0110	3	84	184	109	16	<b>75,53 €</b>	1	8
6004.0111	4	85	227	131	16	<b>122,34 €</b>	1	6

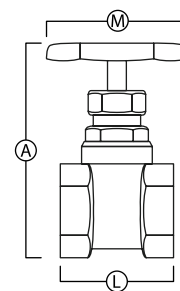

## TT313

Válvula c/ Postigo Vedação Metal  
Válvula Clapeta Cierre Metálico  
Metal Swing Check Valve  
Vanne Retenue Siège Métallique



Ref.		L	A	PN	€/Un.		
6013.0103	1/2	48	48,5	16	<b>3,72 €</b>	18	216
6013.0104	3/4	52	57,8	16	<b>5,74 €</b>	10	120
6013.0105	1	63	65,3	16	<b>7,00 €</b>	8	96
6013.0106	1 1/4	70	78	10	<b>13,49 €</b>	6	36
6013.0107	1 1/2	80	83,5	10	<b>17,48 €</b>	4	24
6013.0108	2	89	98,5	10	<b>25,50 €</b>	3	18
6013.0109	2 1/2	120	127,5	8	<b>45,00 €</b>	1	14
6013.0110	3	135	145	8	<b>73,76 €</b>	1	8

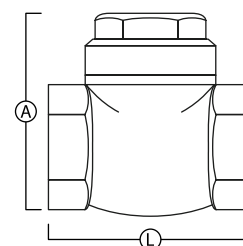

## TT314

Válvula c/ Postigo Vedação Borracha  
Válvula Clapeta Cierre Goma  
Rubber Swing Check Valve  
Vanne Retenue Siège Coautchouc



Ref.		L	A	PN	€/Un.		
6014.0103	1/2	48	48,5	16	<b>3,72 €</b>	18	216
6014.0104	3/4	52	57,8	16	<b>5,74 €</b>	10	120
6014.0105	1	63	65,3	16	<b>7,00 €</b>	8	96
6014.0106	1 1/4	70	78	10	<b>13,49 €</b>	6	36
6014.0107	1 1/2	80	83,5	10	<b>17,48 €</b>	4	24
6014.0108	2	89	98,5	10	<b>25,50 €</b>	3	18
6014.0109	2 1/2	120	127,5	8	<b>45,00 €</b>	1	14
6014.0110	3	135	145	8	<b>73,76 €</b>	1	8

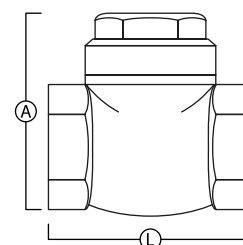

# Válvulas Retenção

Válvulas Retención / Check Valves / Non Retour Vannes



TT319  
Filtro Y  
Filtro Y  
Filter Y  
Filtre Y

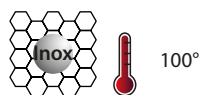

Ref.		L	A	PN	€/Un.		
6019.0103	1/2	49	33,5	16	<b>3,41 €</b>	20	240
6019.0104	3/4	66	46	16	<b>5,31 €</b>	20	120
6019.0105	1	74	52	16	<b>7,33 €</b>	15	90
6019.0106	1 1/4	92	63	16	<b>14,51 €</b>	6	36
6019.0107	1 1/2	102	72	16	<b>18,28 €</b>	2	24
6019.0108	2	120	87	16	<b>31,37 €</b>	2	12
6019.0109	2 1/2	146	107	16	<b>65,84 €</b>	1	12
6019.0110	3	170	123	16	<b>76,91 €</b>	1	8
6019.0111	4	210	151,5	16	<b>151,74 €</b>	1	4

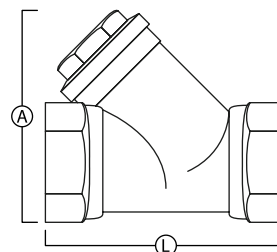

TT315  
Válvula Retenção c/ Mola  
Válvula Retención c/ Muella  
Spring Check Valve  
Clapet Non Retour a/ Resort



Ref.		L	A	PN	€/Un.		
6015.0103	1/2	33	43	16	<b>2,92 €</b>	19	228
6015.0104	3/4	36,5	45,5	16	<b>3,70 €</b>	16	144
6015.0105	1	48	56	16	<b>5,14 €</b>	9	108
6015.0106	1 1/4	59	61	10	<b>8,29 €</b>	6	72
6015.0107	1 1/2	68	68	10	<b>11,83 €</b>	6	36
6015.0108	2	81	77	10	<b>16,45 €</b>	3	18
6015.0109	2 1/2	103	93	8	<b>36,00 €</b>	2	16
6015.0110	3	111	97	8	<b>47,00 €</b>	1	8
6015.0111	4	140	110	8	<b>82,61 €</b>	1	4

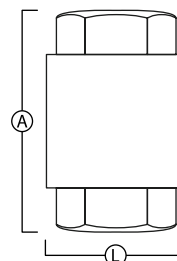

TT315L  
Válvula Retenção c/ Mola  
Válvula Retención c/ Muella  
Spring Check Valve  
Clapet Non Retour a/ Resort

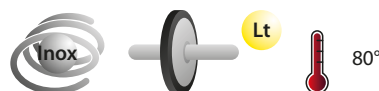

Ref.		L	A	PN	€/Un.		
6015.0003	1/2	33	43	16	<b>3,20 €</b>	19	228
6015.0004	3/4	36,5	45,5	16	<b>4,54 €</b>	16	144
6015.0005	1	48	56	16	<b>6,14 €</b>	9	108
6015.0006	1 1/4	59	61	10	<b>8,97 €</b>	6	72
6015.0007	1 1/2	68	68	10	<b>13,30 €</b>	6	36
6015.0008	2	81	77	10	<b>20,90 €</b>	3	18
6015.0009	2 1/2	103	93	8	<b>48,70 €</b>	2	16
6015.0010	3	111	97	8	<b>62,77 €</b>	1	8

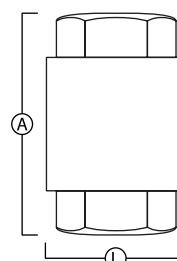

# Válvulas Retenção

Válvulas Retención / Check Valves / Non Retour Vannes



## TT695

### Válvula Retenção c/ Mola

Válvula Retención c/ Muella

Spring Check Valve

Clapet Non Retour a/ Resort

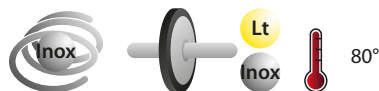

Ref.		L	A	PN	€/Un.		
6095.0003	1/2	34,5	57	25	<b>4,24 €</b>	20	240
6095.0004	3/4	42	64	25	<b>6,30 €</b>	12	144
6095.0005	1	47,5	75	25	<b>9,37 €</b>	15	90
6095.0006	1 1/4	60,5	83	16	<b>14,50 €</b>	8	48
6095.0007	1 1/2	71	93	16	<b>20,57 €</b>	6	36
6095.0008	2	87	100	16	<b>30,00 €</b>	3	18
6095.0009	2 1/2	119	120	10	<b>74,51 €</b>	1	6
6095.0010	3	140	140	10	<b>104,80 €</b>	1	4
6095.0011	4	154	158	10	<b>159,57 €</b>	1	3

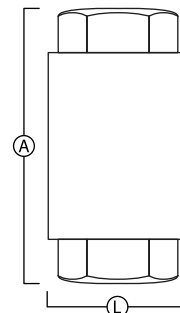

## TT687

### Válvula Artesiana

Válvula Fondo

Foot Check Valve

Clapet de Pied

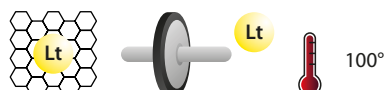

Ref.		L	A	PN	€/Un.		
6087.0003	1/2	39	62	16	<b>3,40 €</b>	15	240
6087.0004	3/4	44	70	16	<b>4,70 €</b>	18	216
6087.0005	1	48	76	16	<b>6,95 €</b>	18	108
6087.0006	1 1/4	60	94	16	<b>10,43 €</b>	8	48
6087.0007	1 1/2	68	100,5	16	<b>15,06 €</b>	3	36
6087.0008	2	80	119	16	<b>23,69 €</b>	3	18
6087.0009	2 1/2	86	140	16	<b>40,00 €</b>	1	20
6087.0010	3	111	150	16	<b>50,00 €</b>	1	12
6087.0011	4	143	185	16	<b>70,57 €</b>	1	6

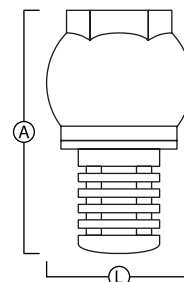

## TT3155

### Válvula Fundo Poço c/ Filtro

Válvula Retorción Poço c/ Filtro

Foot Check Valve w/ Filter

Clapet Non Retour a/ Filtre



Ref.		L	A	PN	€/Un.		
6015.0203	1/2	33	66	16	<b>2,43 €</b>	36	216
6015.0204	3/4	42	71	16	<b>3,14 €</b>	18	216
6015.0205	1	48	87	16	<b>3,96 €</b>	14	84
6015.0206	1 1/4	59	97	10	<b>5,79 €</b>	8	48
6015.0207	1 1/2	68	111	10	<b>9,18 €</b>	3	36
6015.0208	2	81	129	10	<b>14,88 €</b>	2	12
6015.0209	2 1/2	103	159,5	8	<b>30,00 €</b>	1	12
6015.0210	3	111	170	8	<b>45,00 €</b>	1	8
6015.0211	4	140	193,5	8	<b>60,00 €</b>	1	4

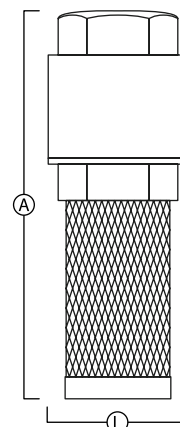

# Válvulas Retenção

Válvulas Retención / Check Valves / Non Retour Vannes



## TT315NF

Válvula Retenção c/ Mola c/ Filtro  
Válvula Retención c/ Mola c/ Filtro  
Spring Check Valve w/ Filter  
Clapet Non Retour a/ Resort a/ Filtre

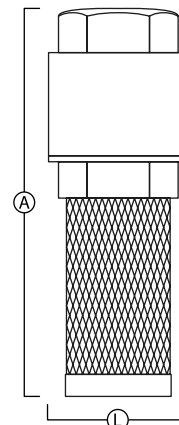

Ref.		L	A	PN	€/Un.		
6015.0303	1/2	30	65	16	<b>5,53 €</b>	36	216
6015.0304	3/4	37	90	16	<b>5,85 €</b>	24	144
6015.0305	1	44	100	16	<b>6,83 €</b>	15	90
6015.0306	1 1/4	56	111	10	<b>9,78 €</b>	8	48
6015.0307	1 1/2	63	124	10	<b>11,17 €</b>	3	36
6015.0308	2	78	144	10	<b>17,87 €</b>	2	22
6015.0309	2 1/2	102	175	8	<b>38,31 €</b>	1	6



## TT315LF

Válvula Retenção c/ Mola c/ Filtro  
Válvula Retención c/ Mola c/ Filtro  
Spring Check Valve w/ Filter  
Clapet Non Retour a/ Resort a/ Filtre

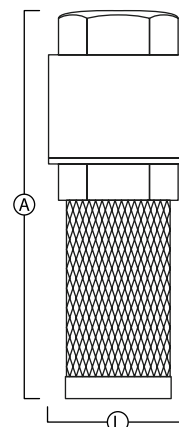
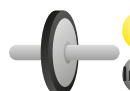

Ref.		L	A	PN	€/Un.		
6015.0403	1/2	34,5	85	25	<b>6,15 €</b>	21	126
6015.0404	3/4	42	113	25	<b>7,33 €</b>	12	72
6015.0405	1	47,5	123	25	<b>11,22 €</b>	8	48
6015.0406	1 1/4	60,5	150	16	<b>17,09 €</b>	8	32
6015.0407	1 1/2	71	165	16	<b>23,17 €</b>	2	24
6015.0408	2	87	190	16	<b>33,99 €</b>	2	15
6015.0409	2 1/2	119	200	10	<b>81,79 €</b>	1	6
6015.0410	3	140	245	10	<b>108,05 €</b>	1	3



## TT318

Filtro Inox  
Filtro Inox  
S. S. filter  
Filtre Inox



1200 µ

Ref.		L	A	€/Un.		
6018.0103	1/2	27,5	39	<b>1,12 €</b>	54	648
6018.0104	3/4	35	39,5	<b>1,39 €</b>	32	384
6018.0105	1	41,5	51	<b>1,67 €</b>	30	180
6018.0106	1 1/4	50	56	<b>1,96 €</b>	20	120
6018.0107	1 1/2	58	65	<b>2,23 €</b>	6	72
6018.0108	2	70	78	<b>3,30 €</b>	4	48



# Torneiras c/ Boia

Flotadores Boya | Float Valves | Robinet a/ Flotteur

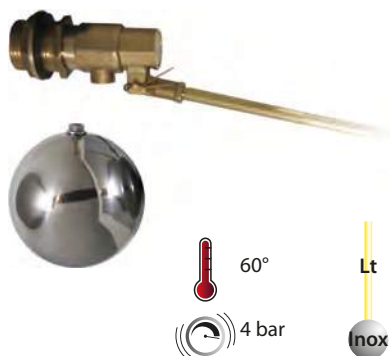

717  
Torneira c/ Boia Inox  
Flotador Boya Inox  
Float Valve S. S.  
Robinet à Flotteur Boule Inox

Ref.		€/Un.		
0717.0103	1/2	10,00 €	1	40
0717.0104	3/4	12,00 €	1	36
0717.0105	1	23,00 €	1	40
0717.0106	1 1/4	40,00 €	1	12
0717.0107	1 1/2	60,00 €	1	5
0717.0108	2	70,00 €	1	5



718  
Torneira Ing. c/ Boia Plástico  
Flotador Boya  
Float Valve  
Robinet à Flotteur

Ref.		€/Un.		
0718.0003	1/2	13,00 €	1	20
0718.0004	3/4	14,00 €	1	14
0718.0005	1	18,32 €	1	10



719  
Torneira Boia c/ Guia  
Flotador Boya c/ Guia  
Float Valve w/ Guide  
Robinet à Flotteur a/ Guides

Ref.		€/Un.		
0719.0003	1/2	12,00 €	1	12
0719.0004	3/4	15,00 €	1	10
0719.0005	1	19,00 €	1	10
0718.0006	1 1/4	37,89 €	1	10
0718.0007	1 1/2	49,47 €	1	6
0718.0008	2	65,00 €	1	5

# 2.1

## Válvulas e Torneiras Bugatti

Válvulas y Grifos Bugatti | Valves and Bibcocks Bugatti | Vannes et Robinets Bugatti

Aplicações Aplicações / Applications / Application



www.bugattivalves.



**BUGATTI**  
VALVOSANITARIA

certificata e autorizzata da ACCREDIA  
certified and authorized by ACCREDIA



www.bugattivalves

**BUGATTI**  
VALVOSANITARIA



**BUGATTI**  
VALVOSANITARIA

### Latão CW617N

Latón CW617N  
Brass CW617N  
Laiton CW617N

### Rosca Paralela IS0228/1

Rosca Paralela IS0228/1  
Parallel Thread IS0228/1  
Filetage Parallèle IS0228/1

### Norma EN13828

Norma EN13828  
Standard EN13828  
Norme EN13828

### Passagem Total

Paso Total  
Full Port  
passage Integral



-20 °C  
+120 °C

# Válvulas e Torneiras Bugatti

Válvulas y Grifos Bugatti / Valves and Bibcocks Bugatti / Vannes et Robinets Bugatti



601  
Válvula Esfera F/F  
Ball Valve F/F

Válvula Esfera H/H  
Vanne à Sphère F/F

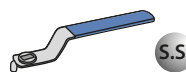

Manipulo Inox

Ref.		L	M	A	PN	€/Un.		
0300.0203	1/2	47	41	85	40	3,49 €	20	80
0300.0204	3/4	55	43,5	85	25	4,99 €	14	56
0300.0205	1	65	52	96,5	25	7,99 €	10	40
0300.0206	1 1/4	74	58	120	20	13,75 €	4	16
0300.0207	1 1/2	83	63,5	120	20	19,30 €	3	12
0300.0208	2	97	77	162	20	31,13 €	2	8

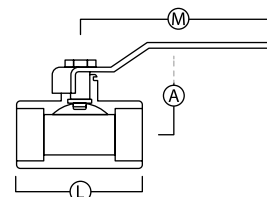

606  
Válvula Esfera M/F  
Ball Valve M/F

Válvula Esfera M/H  
Vanne à Sphère M/F

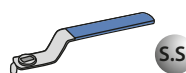

Manipulo Inox

Ref.		L	M	A	PN	€/Un.		
0300.0213	1/2	55	41	85	40	4,10 €	20	80
0300.0214	3/4	61	43,5	85	25	5,92 €	14	56
0300.0215	1	74	52	96,5	25	8,93 €	10	40
0300.0216	1 1/4	84	58	120	20	14,06 €	4	16
0300.0217	1 1/2	94,5	63,5	120	20	20,19 €	3	12
0300.0218	2	109	77	162	20	33,14 €	2	8

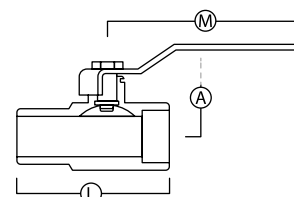

602  
Válvula Esfera Borboleta F/F  
Butterfly Ball Valve F/F

Válvula Esfera Mariposa H/H  
Vanne à Sphère Pampillon F/F

Ref.		L	M	A	PN	€/Un.		
0301.0103	1/2	47	40,5	53	40	3,58 €	24	96
0301.0104	3/4	55	43	53	25	5,24 €	20	80
0301.0105	1	65	53,5	63	25	8,01 €	10	40

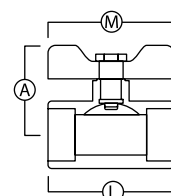

607  
Válvula Esfera Borboleta M/F  
Butterfly Ball Valve M/F

Válvula Esfera Mariposa M/H  
Vanne à Sphère Pampillon M/F

Ref.		L	M	A	PN	€/Un.		
0302.0103	1/2	47	40,5	53	40	3,58 €	24	96
0302.0104	3/4	55	43	53	25	5,24 €	20	80
0302.0105	1	65	53,5	63	25	8,01 €	10	40

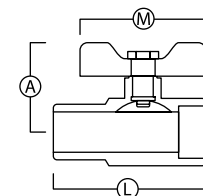

Manipulo Inox



678  
Torneira Esfera c/ Junção  
Hose Bibcock

Grifo Esfera  
Robinnet

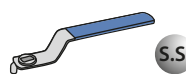

Ref.		L	M	A	PN	€/Un.		
0307.0113	1/2x3/4	87	37	85	16	5,00 €	12	48
0307.0114	3/4x1	100,5	39,5	85	16	6,60 €	8	32
0307.0115	1x1 1/4	120	40	85	16	13,50 €	5	20

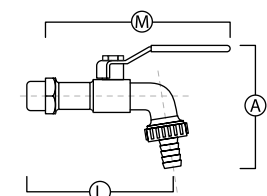



# Válvulas e Torneiras Bugatti

Válvulas y Grifos Bugatti / Valves and Bibcocks Bugatti / Vannes et Robinets Bugatti



332  
Válvula Esfera c/ Purga  
Válvula Esfera c/ Purga  
Bleed Ball Valve  
Vanne à Sphère Vidange

Ref.		€/Un.		
0326.0104	3/4	9,00 €	10	40
0326.0105	1	15,60 €	6	24



691N  
Torneira Esfera Anti-Gelo  
Grifo Esfera Anti-Hielo  
Bibcock Anti-Frost  
Robinet Anti-Givre



Ref.		€/Un.		
0307.0133	1/2x3/4	11,00 €	10	40
0307.0134	3/4x1	15,00 €	8	32



681  
Torneira Esfera Barril Cromado  
Grifo Esfera Barril Cromo  
Tank Bibcock Chrome  
Robinet Chromé



Ref.		€/Un.		
0308.0002	3/8	6,00 €	20	80
0308.0003	1/2	6,00 €	20	80



604  
Válvula Esfera Selar  
Vanne à Sphère Capuchon Carré  
Square Cap Ball Valve  
Válvula Esfera Cuadradillo

Ref.		€/Un.		
0303.0103	1/2	5,12 €	20	80
0303.0104	3/4	7,06 €	14	56
0303.0105	1	10,50 €	10	40
0303.0106	1 1/4	20,00 €	4	16
0303.0107	1 1/2	30,00 €	3	12
0303.0108	2	50,00 €	2	8



697  
Torneira Esfera Barril  
Grifo Esfera Barril  
Tank Bibcock  
Robinet à Multi-Boutaille

Ref.		€/Un.		
0308.0102	3/8	7,20 €	14	56
0308.0103	1/2	7,20 €	14	56
0308.0104	3/4	9,00 €	10	40
0308.0105	1	17,00 €	8	32



871/890  
Torneira Esfera c/ Filtro  
Válvula Escuadra c/ Filtro  
Angle Valve w/ Filter  
Robinet Sous-Lavado a/ Filtre



Ref.		€/Un.		
0309.0102	1/2x3/8	6,20 €	15	60
0309.0103	1/2x1/2	6,20 €	15	60
0309.0104	1/2x3/4	7,00 €	15	60



884  
Torneira Esfera Máquina Lavar  
Válvula Esfera Lavadora  
Washing Machine Ball Valve  
Robinet à Sphère a/ Laveuse



Ref.		€/Un.		
0310.0103	1/2x1/2	5,00 €	25	100
0310.0104	1/2x3/4	5,00 €	25	100



840  
Torneira Máquina Lavar  
Grifo Lavadora  
Washing Machine Tap  
Robinet Pour Laveuse



Ref.		€/Un.		
0310.0403	1/2x3/4	6,27 €	15	60



878  
Torneira Esquadria  
Válvula Escuadra c/ Punho  
Angle Valve w/ Filter  
Robinet Sous-Lavabo a/ Poiquée



Ref.		€/Un.		
0310.0303	1/2x1/2	7,00 €	20	80



# Válvulas e Torneiras Bugatti

Válvulas y Grifos Bugatti / Valves and Bibcocks Bugatti / Vannes et Robinets Bugatti



**800**  
Torneira Esfera Mini F/F  
Grifo Esfera Mini H/H  
Mini Ball Valve F/F  
Mini-Vanne F/F

Ref.		€/Un.		
0311.0103	1/2	<b>4,58 €</b>	50	200



**805**  
Torneira Esfera Mini M/F  
Grifo Esfera Mini M/H  
Mini Ball Valve M/F  
Mini-Vanne M/F

Ref.		€/Un.		
0312.0103	1/2	<b>4,58 €</b>	50	200



**1010**  
Manipulo p/ Válvula Inox  
Maneta Inox  
S. S. Handle  
Levier Inox

S.S.

Ref.		€/Un.	
0321.0203	1/2-3/4	<b>1,35 €</b>	10
0321.0205	1	<b>1,90 €</b>	10
0321.0206	1 1/4-1 1/2	<b>2,60 €</b>	5
0321.0208	2	<b>4,50 €</b>	2



**693**  
Junção p/ Torneira Esfera  
Portagoma  
Hose Connection  
Porte-Caoutchouc

Ref.		€/Un.		
0317.0104	1/2x3/4	<b>1,20 €</b>	100	400
0317.0105	3/4x1	<b>1,85 €</b>	50	200
0317.0106	1x1 1/4	<b>3,90 €</b>	25	100

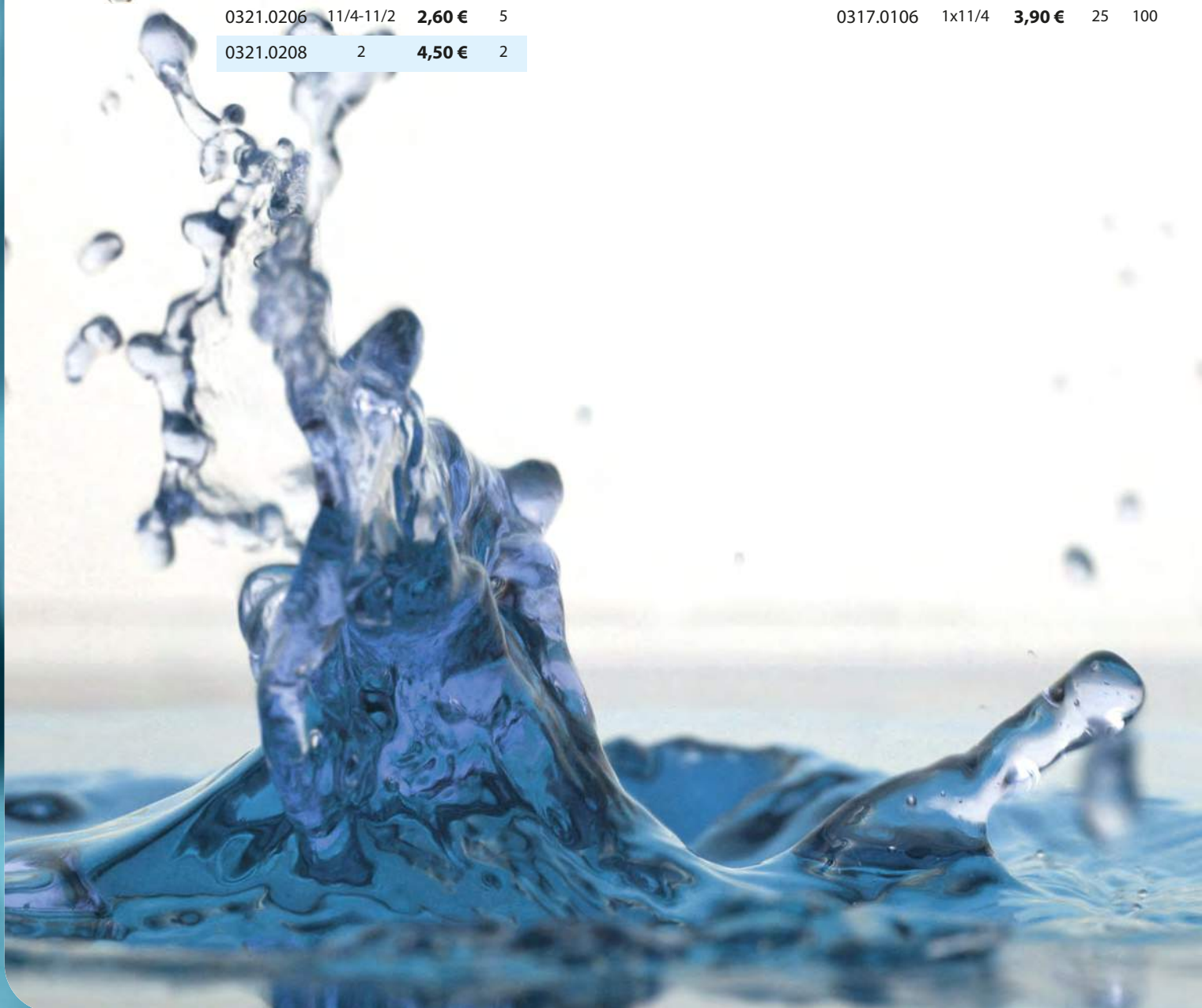

# 2.2

## Válvulas de Esfera PVC





## Válvula de esfera Ø 125 mm. Paso total. Ref. 52306

Interior totalmente liso.



**PN6** - Diámetro de paso 113 mm (correspondiente al de una tubería de PVC de Ø125 mm y PN 10 atm.)  
Aplicaciones: Riego, industria agroalimentaria, industria piscícola.

**PN6** - Diâmetro de passagem 113 mm (correspondente ao de uma tubagem de PVC de Ø125 mm / PN 10 atm.)  
Aplicações: Rega, indústria agroalimentaria, indústria piscícola.

- Mínima pérdida de carga.
- No existe estrechamiento en su paso por la bola, lo que evita obturaciones y permite el paso de productos sólidos, esta cualidade la hace idónea para la industria agroalimentaria (almazaras, bodegas, conserveras...)
- Mínima perda de carga.
- Não existe estreitamento na passagem pela bola, o que evita obstruções e permite uma passagem de produtos sólidos, esta qualidade a faz idónea para a indústria agroalimentar (lagares de azeite, adegas, fábricas de conservas...)

- Nuevo dispositivo de Bloqueo / Desbloqueo de tuerca, para evitar desaprietas por dilataciones o vibraciones en la tubería.
- Novo dispositivo de Bloqueio / Desbloqueio da porca, para evitar desapertos por dilatações ou vibrações na tubagem.



Encolar / Colável

Ref.		€/Un.	
52201	20		30
52202	25		20
52203	32		15
52204	40		10
52205	50		10
52206	63		10
52207	75 *		4
52208**	90 *		3
52320**	110 DN80 *		1
52209	110 *		2
52297**	125 DN100 *		2
52306	125 *		1

Paso total / Passagem total

\*\* paso reducido / \*\* passagem reduzida



Roscar hembra / Rosca fêmea

Ref.		€/Un.	
52234	1/2		30
52235	3/4		20
52236	1		15
52237	1 1/4		10
52238	1 1/2		10
52239	2		10
52240	2 1/2 *		4



Enlace tubo polietileno / União tubo polietileno

Ref.		€/Un.	
52281	20		30
52282	25		20
52283	32		15
52284	40		10
52285	50		10
52286	63		10
52287	75 *		4
52288	90 *		3

\* Las medidas de 75, 90 110, 125, 2 1/2" y 3" cuerpo en PP (polipropileno).

\* As medidas 75, 90 110, 125, 2 1/2" e 3" corpo em PP.

# 2.3

## Accesórios Aperto Rápido p/ Tubo PE

Accesórios Compresión p/Tubo PE  
Compression Fittings f/ PE Pipe  
Raccords Compresion p/ Tuyau PE

### Latão CW617N

Latón CW617N  
Brass CW617N  
Laiton CW617N



### Rosca Paralela ISO228/1

Rosca Paralela ISO228/1  
Parallel Thread ISO228/1  
Filetage Parallèle ISO228/1

Ø 20-63 - PN 20  
Ø 75-110 - PN 30

80 °C



8015  
União Simples  
Unión  
Straight Coupling  
Manchon

Ref.		€/Un.		
0377.0103	20	<b>3,60 €</b>	20	80
0377.0106	25	<b>4,94 €</b>	15	60
0377.0109	32	<b>8,04 €</b>	8	32
0377.0112	40	<b>12,87 €</b>	4	16
0377.0113	50	<b>18,19 €</b>	3	12
0377.0114	63	<b>31,18 €</b>	2	8



8000  
Junção Direita M  
Unión Recta M  
Straight M Coupling  
Raccord Mâle

Ref.		€/Un.		
0375.0103	20x1/2	<b>2,32 €</b>	40	160
0375.0106	25x3/4	<b>3,03 €</b>	20	80
0375.0109	32x1	<b>5,15 €</b>	12	48
0375.0112	40x1 1/4	<b>8,63 €</b>	8	32
0375.0113	50x1 1/2	<b>11,76 €</b>	6	24
0375.0114	63x2	<b>20,39 €</b>	2	8



3015  
União c/ Flanges  
Unión c/ Brida  
Straight w/ Flange  
Manchon a/ Etau

Ref.		€/Un.	
0377.0115	75	<b>100,00 €</b>	6
0377.0116	90	<b>142,50 €</b>	4
0377.0117	110	<b>310,00 €</b>	2



3000  
Junção Direita M c/ Flanges  
Unión Recta M c/ Brida  
Straight M Coupling w/ Flange  
Raccord Mâle a/ Etau

Ref.		€/Un.	
0375.0115	75x21/2	<b>60,00 €</b>	8
0375.0116	90x3	<b>82,26 €</b>	6
0375.0117	100x4	<b>160,00 €</b>	2



# Acessórios Aperto Rápido p/ Tubo PE

Accesorios Compresión p/ Tubo PE | Compression Fittings f/ PE Pipe | Raccords Compression p/ Tuyau PE



**8005**  
Junção Direita F  
Unión Recta F  
Straight F Coupling  
Raccord F

Ref.		€/Un.		
0376.0103	20x1/2	<b>2,25 €</b>	40	160
0376.0106	25x3/4	<b>3,08 €</b>	20	80
0376.0109	32x1	<b>4,99 €</b>	12	48
0376.0112	40x1 1/4	<b>8,27 €</b>	8	32
0376.0113	50x1 1/2	<b>12,03 €</b>	6	24
0376.0114	63x2	<b>20,12 €</b>	2	8



**8039**  
Joelho Simples 90°  
Codo Igual 90°  
Equal Elbow 90°  
Coude Égal 90°

Ref.		€/Un.		
0383.0103	20	<b>4,63 €</b>	20	80
0383.0106	25	<b>6,27 €</b>	12	48
0383.0109	32	<b>10,39 €</b>	7	28
0383.0112	40	<b>16,88 €</b>	3	12
0383.0113	50	<b>24,38 €</b>	2	8
0383.0114	63	<b>41,39 €</b>	1	4



**3005**  
Junção Direita F c/ Flanges  
Unión Recta H c/ Brida  
Straight F Coupling w/ Flange  
Raccord F a/ Etau

Ref.		€/Un.	
0376.0115	75x2 1/2	<b>55,00 €</b>	8
0376.0116	90x3	<b>80,00 €</b>	6
0376.0117	110x4	<b>170,00 €</b>	3



**3039**  
Joelho 90° c/ Flanges  
Codo 90° c/ Brida  
Elbow 90° w/ Flange  
Coude 90° a/ Etau

Ref.		€/Un.	
0383.0115	75	<b>120,00 €</b>	3
0383.0116	90	<b>204,39 €</b>	1



**8035**  
Joelho 90° M  
Codo 90° M  
Elbow 90° M  
Coude 90° M

Ref.		€/Un.		
0381.0103	20x1/2	<b>3,48 €</b>	25	100
0381.0106	25x3/4	<b>4,76 €</b>	15	60
0381.0109	32x1	<b>7,88 €</b>	10	40
0381.0112	40x1 1/4	<b>13,10 €</b>	5	20
0381.0113	50x1 1/2	<b>18,38 €</b>	3	12
0381.0114	63x2	<b>32,12 €</b>	2	8



**8037**  
Joelho 90° F  
Codo 90° H  
Elbow 90° F  
Coude 90° F

Ref.		€/Un.		
0382.0103	20x1/2	<b>3,35 €</b>	25	100
0382.0106	25x3/4	<b>4,49 €</b>	15	60
0382.0109	32x1	<b>7,31 €</b>	10	40
0382.0112	40x1 1/4	<b>11,94 €</b>	5	20
0382.0113	50x1 1/2	<b>17,23 €</b>	3	12
0382.0114	63x2	<b>30,13 €</b>	2	8



**3035**  
Joelho 90° M c/ Flanges  
Codo 90° M c/ Brida  
Elbow 90° M w/ Flange  
Coude 90° M a/ Etau

Ref.		€/Un.	
0381.0115	75x2 1/2	<b>90,00 €</b>	4
0381.0116	90x3	<b>140,00 €</b>	3



**3037**  
Joelho 90° F c/ Flanges  
Codo 90° H c/ Brida  
Elbow 90° F w/ Flange  
Coude 90° F a/ Etau



Ref.		€/Un.	
0382.0115	75x2 1/2	<b>85,00 €</b>	4
0382.0116	90x3	<b>148,00 €</b>	3

# Acessórios Aperto Rápido p/ Tubo PE

Accesorios Compresión p/ Tubo PE | Compression Fittings f/ PE Pipe | Raccords Compression p/ Tuyau PE



**8030**  
Tê Simples  
Te Igual  
Equal Tee  
Té Egal

Ref.		€/Un.		
0380.0103	20	<b>6,54 €</b>	10	40
0380.0106	25	<b>8,91 €</b>	8	32
0380.0109	32	<b>14,87 €</b>	5	20
0380.0112	40	<b>24,24 €</b>	2	8
0380.0113	50	<b>35,45 €</b>	1	4
0380.0114	63	<b>63,47 €</b>	1	4





**8025**  
Tê F  
Te H  
F Tee  
Té F

Ref.		€/Un.		
0379.0103	20x1/2	<b>5,17 €</b>	15	60
0379.0106	25x3/4	<b>7,10 €</b>	8	32
0379.0109	32x1	<b>11,91 €</b>	5	20
0379.0112	40x11/4	<b>18,95 €</b>	3	12
0379.0113	50x11/2	<b>27,48 €</b>	2	8
0379.0114	63x2	<b>49,15 €</b>	1	4





**8080**  
Joelho c/ Pater  
Codo Mural  
Wall Plated Elbow  
Coude Mural

Ref.		€/Un.		
0384.0903	20x1/2	<b>5,50 €</b>	15	60
0384.0905	25x3/4	<b>8,00 €</b>	10	40
0384.0906	32x3/4	<b>11,94 €</b>	6	24
0384.0907	32x1	<b>11,94 €</b>	6	24



**6200**  
Casquilho Pressão  
Cono Presión  
Pressure Cone  
Cone de Presion

Ref.		€/Un.		
0387.0102	20-G	<b>1,40 €</b>	100	400
0387.0103	25-G	<b>1,50 €</b>	100	400
0387.0104	32-G	<b>1,80 €</b>	30	120
0387.0105	40-G	<b>2,40 €</b>	30	120
0387.0106	50-G	<b>3,70 €</b>	25	100
0387.0107	63-G	<b>4,00 €</b>	10	40
0387.0202	20-A	<b>1,40 €</b>	100	400
0387.0203	25-A	<b>1,50 €</b>	100	400
0387.0204	32-A	<b>1,80 €</b>	30	120
0387.0205	40-A	<b>2,40 €</b>	30	120
0387.0206	50-A	<b>3,70 €</b>	25	100
0387.0207	63-A	<b>4,00 €</b>	7	28

G - Gás/Gas/Gas/Gaz  
A - Água/Agua/Water/Eau

# 2.4

## Acessórios de Aperto Rápido p/ Tubo PE





# Acessórios de Aperto Rápido p/ Tubo PE



**0,6 Mpa. 1,0 Mpa. 1,6 Mpa.**

<b>PE 40</b>		
<b>PE 100</b>		

Los accesorios para tubo de Polietileno Gama-55 de Jimten, S. A. cumplen sobradamente las especificaciones de las siguientes Normas para accesorios:

- Las roscas se fabrican según: UNE 19009, ISO R-7, UNI 338, DIN 2999.
- Las bridas se fabrican según: UNE 19 153 ISO2084, UNI 7442, DIN 8063.

Os acessórios para tubo de Polietileno Gama - 55 da Jimten, cumprem as especificações das seguintes Normas de acessórios:

- As roscas são feitas segundo: UNE 19009, ISO R-7, UNI 338, DIN 2999.
- As flanges são feitas segundo: UNE 19 153 ISO2084, UNI 7442, DIN 8063.

\* Para obtener un resultado satisfactorio, en instalaciones con tuberías de PEHD, es necesario insertar un liner en el interior del tubo. (ver pag. 160)  
 \* Para obter um resultado satisfatório, em instalações com tubagens de PEHD, é necessário inserir um liner no interior do tubo. (ver pag. 160)

Los accesorios para tubos de Polietileno, Gama -55 de Jimten, S. A., han sido probados y CERTIFICADOS por los siguientes organismos internacionales:  
 Os acessórios para tubos de Polietileno, Gama- 55 Jimten, foram comprovados e CERTIFICADOS pelas seguintes organizações internacionais:



- Certificación por Aenor de la gama "Fitting" marca JIMTEN - España. Según normas UNE EN 715, 911, 713, 112.  
 Ø20 a 63 mm  
 UNE-EN 12201-5  
 0,6-1,0 (PE40) - 1,6 (PE 100)



- Certificadode conformidad técnica (Polonia)







### J-61

Enlance mixto rosca macho / União mista rosca macho

Ref.		€/Un.	
55148	16-3/8		50
55147	16-1/2		50
55011	20-1/2		100
55132	20-3/4		50
55133	25-1/2		50
55012	25-3/4		100
55213	25-1"		50
55214	32-3/4"		50
55013	32-1		100
55215	32-1 1/4"		50
55216	40-1"		50
55014	40-11/4		100
55001	50-11/2		25
55002	63-2		25
55015	75-21/2		5
55016	90-3		5
55192	110-4"		2



### J-68

Enlance redeucido/ União redução

Ref.		€/Un.	
55153	20-16		50
55229	25-16		50
55041	25-20		50
55042	32-25		25
55043	40-32		25
55044	50-40		15
55045	63-50		15
55070	75-63		5
55071	90-75		5
55221	110-90		2

## SIN REFUERZO METALICO SEM REFORÇO METÁLICO



### J-72

Codo grifo / Curva torneira

Ref.		€/Un.	
55076	20-1/2		50
55077	25-3/4		50
55139	32-1		25
55140	40-11/4		25



### J-63

Enlance recto / União reta

Ref.		€/Un.	
55149	16		50
55017	20		100
55018	25		100
55019	32		50
55020	40		50
55003	50		25
55004	63		20
55021	75		5
55022	90		5
55165	110		2
55151	110		2

## CON REFUERZO METALICO COM REFORÇO METÁLICO



### J-72

Codo grifo / Curva torneira

Ref.		€/Un.	
55228	16 1/2"		50
55179	20-1/2"		50
55180	25-3/4"		50
55181	32-1"		25
55182	40-1 1/4		25

## SIN REFUERZO METALICO SEM REFORÇO METÁLICO



### J-62

Enlace mixto rosca hembra / União mista rosca fêmea

Ref.		€/Un.	
55155	16-3/8		50
55152	16-1/2		50
55035	20-1/2		100
55134	25-1/2		50
55036	25-3/4		100
55246	25-1		50
55037	32-1		100
55038	40-1 1/4		50
55005	50-1 1/2		25
55006	63-2		25
55039	75-2 1/2		5
55040	90-3		5
55193	110-4"		2

## CON REFUERZO METALICO COM REFORÇO METÁLICO



### J-62

Enlace mixto rosca hembra / União mista rosca fêmea

Ref.		€/Un.	
55169	20-1/2		100
55170	25-1/2		50
55171	25-3/4		100
55247	25-1		50
55172	32-1"		100
55173	40-1 1/4"		50
55174	50-1 1/2"		25
55144	63-2		25
55145	75-2 1/2		5
55146	90-3		5
55226	110-4"		2

## SIN REFUERZO METALICO SEM REFORÇO METÁLICO



### J-71

Enlace acodado 90° rosca hembra / União curva 90° rosca fêmea

Ref.		€/Un.	
55135	20-1/2		50
55218	25-1/2"		50
55136	25-3/4		50
55137	32-1"		25
55242	32-3/4		25
55138	40-1 1/4		25
55159	50-1 1/2		20
55160	63-2		20
55254	75-2 1/2"		10
55255	90-3"		6
55256	110-4"		4

## CON REFUERZO METALICO COM REFORÇO METÁLICO



### J-71

Enlace acodado 90° rosca hembra / União curva 90° rosca fêmea

Ref.		€/Un.	
55175	20-1/2		50
55225	25-1/2"		50
55176	25-3/4		50
55243	32-3/4		25
55177	32-1"		25
55178	40-1 1/4		25
55188	50-1 1/2		20
55189	63-2		20
55257	75-2 1/2"		10
55258	90-3"		6
55259	110-4"		4



### J-64

Enlance acodado 90° / União curva 90°

Ref.		€/Un.	
55154	16		50
55029	20		50
55030	25		50
55031	32		50
55032	40		25
55009	50		15
55010	63		15
55033	75		5
55034	90		5
55190	110		2



### J-70

Enlance acodado 45° rosca macho / União curva 45° rosca macho

Ref.		€/Un.	
55090	20-1/2		50
55091	25-3/4		50
55092	32-1		25
55093	40-11/4		25
55094	50-11/2		10
55095	63-2		10
55161	75		6
55162	90		4



### J-69

Enlance acodado rosca macho 90° / União curva 90° rosca macho

Ref.		€/Un.	
55096	20-1/2		50
55217	25-1/2"		50
55097	25-3/4		50
55098	32-1		25
55099	40-11/4		25
55163	50-11/2		20
55164	63-2		20
55251	75-2 1/2		10
55252	90-3"		6
55253	110-4"		4



### J-73

Te bocas iguales / Tê bocas iguais

Ref.		€/Un.	
55150	16		50
55072	20		100
55073	25		100
55074	32		25
55075	40		25
55086	50		10
55087	63		10
55088	75		5
55089	90		5
55191	110		2

## SIN REFUERZO METALICO SEM REFORÇO METÁLICO



### J-90

Codo 90° rosca lateral / Curva 90° rosca lateral

Ref.		€/Un.	
55264	25-1/2		50
55266	32-3/4		50

## CON REFUERZO METALICO COM REFORÇO METÁLICO



### J-90

Codo 90° rosca lateral / Curva 90° rosca lateral

Ref.		€/Un.	
55265	25-1/2		50
55267	32-3/4		50



## J-74

Te boca reducida al centro / Tê boca reduzida ao centro

Ref.		€/Un.	
55115	25-20-25		50
55116	32-25-32		25
55117	40-32-40		25
55118	50-40-50		10
55119	63-50-63		10
55120	75-63-75		5
55121	90-75-90		5



## J-75

Te dos bocas reducidas / Tê duas bocas reduzidas

Ref.		€/Un.	
55122	25-20-20		20
55123	32-25-25		20
55124	40-32-32		15
55125	50-40-40		10
55126	63-50-50		10
55127	75-63-63		5
55128	90-75-75		5

## SIN REFUERZO METALICO SEM REFORÇO METÁLICO



## J-65

Derivación te rosca hembra / Derivação tê rosca fêmea

Ref.		€/Un.	
55023	20-1/2		100
55219	25-1/2"		50
55024	25-3/4		100
55244	32-3/4		50
55025	32-1		50
55026	40-1 1/4		50
55007	50-1 1/2		15
55008	63-2		15
55027	75-2 1/2		5
55028	90-3		5
55220	110-4"		2

## CON REFUERZO METALICO COM REFORÇO METÁLICO



## J-65

Derivación te rosca hembra / Derivação tê rosca fêmea

Ref.		€/Un.	
55183	20-1/2		100
55224	25-1/2"		50
55184	25-3/4		100
55245	32-3/4		50
55185	32-1"		50
55186	40-1 1/4		50
55187	50-1 1/2"		15
55141	63-2		15
55142	75-2 1/2		5
55143	90-3		5
55227	110-4"		2



## J-77

Derivación cruz reducida / Derivação cruz reduzida

Ref.		€/Un.	
55129	40-32		15
55130	50-40		10
55131	63-50		10



## J-76

Derivación cruz / Derivação cruz





Ref.		€/Un.	
55112	32		15
55113	40		10
55114	50		10





### J-79





Manguito pasamuros / Canhão depósito

Ref.		€/Un.	
55230	25-3/4"		10
55231	32-1"		10











### J-92

Pasamuros rosca macho / Canhão depósito rosca macho

Ref.		€/Un.	
55688	25-3/4"		10
55689	32-1"		10













Liner Gama 55, para su uso con tubería PEHD / Liner Gama 55

Ref.		€/Un.	
55646	20		150
55647	25		90
55648	32		50
55686	40		30
55649	50		15
55650	63		10



### J-78





Tapón final / Tampão final

Ref.		€/Un.	
55104	20		50
55105	25		50
55106	32		25
55107	40		25
55108	50		10
55109	63		10
55110	75		5
55111	90		5
55223	110		2



### J-60



Derivación te rosca macho / Derivação tê rosca macho

Ref.		€/Un.	
55194	20-1/2"		50
55195	25-3/4"		50
55196	32-1"		25







### J-93

Llave de apriete fitting universal / Chave de aperto fitting universal

Ref.		€/Un.	
55690	16 A 63		10



Llave de apriete fitting Gama 55 / Chave de aperto fitting Gama 55

Ref.		€/Un.	
55248	16-32		20
55249	40-63		20
55250	75-110		10

# 2.5

**Abraçadeiras em PP p/ Tubo PE**





Collarines reforzados (6 tornillos) / Colarinhos reforçados (6 parafusos)

Ref.		€/Un.	
53112	200 x 1 1/4		2
53113	200 x 1 1/2		2
53114	200 x 2"		2
53115	200 x 3"		2
53116	200 x 4"		2
53118	225 x 1 1/2		2
53122	250 x 1 1/4		2
53123	250 x 1 1/2		2
53124	250 x 2"		2
53125	250 x 3"		2
53126	250 x 4"		2
53127	315 x 1 1/4		2
53128	315 x 1 1/2		2
53129	315 x 2"		2
53130	315 x 3"		2
53131	315 x 4"		2

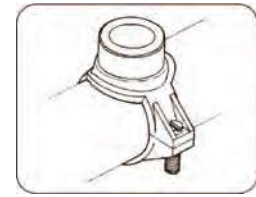

Collarín integral con 1 tornillo / Colarinho/anel integral 1 parafuso

Ref.		€/Un.	
57001	40 x 1/2		25
57002	40 x 3/4		25
57003	50 x 1/2		25
57004	50 x 3/4		25
57005	63 x 1/2		15
57006	63 x 3/4		15
57007	75 x 1/2		15
57008	75 x 3/4		15



Collarín 2 tornillos / Colarinho 2 parafusos

Ref.		€/Un.	
53133	25 x 1/2		100
53041	32 x 1/2		100
53042	32 x 3/4		100
53135	32 x 1"		100
53001	40 x 1/2"		50
53002	40 x 3/4"		50
53003	40 x 1"		50
53004	50 x 1/2"		50
53005	50 x 3/4"		50
53006	50 x 1"		50



Collarín 2 tornillos reforzado / Colarinho 2 parafusos reforçado

Ref.		€/Un.	
53156	25 x 1/2		100
53157	32 x 1/2		100
53158	32 x 3/4		100
53159	32 x 1		100
53160	40 x 1/2		50
53161	40 x 3/4		50
53162	40 x 1		50
53163	50 x 1/2		50
53164	50 x 3/4		50
53165	50 x 1		50



Collarín 4 tornillos / Colarinho 4 parafusos

Ref.		€/Un.	
53007	63 x 1/2"		35
53008	63 x 3/4"		35
53009	63 x 1"		35
53136	63 x 1 1/4"		35
53137	63 x 1 1/2"		35
53010	75 x 1/2"		20
53011	75 x 3/4"		20
53012	75 x 1"		20
53138	75 x 1 1/4"		20
53139	75 x 1 1/2"		20
53140	75 x 2"		20
53141	90 x 1/2"		15
53048	90 x 3/4"		15
53049	90 x 1"		15
53050	90 x 1 1/4"		15
53033	90 x 1 1/2"		15
53034	90 x 2"		15
53142	110 x 1/2"		6
53051	110 x 3/4"		6
53052	110 x 1"		6
53053	110 x 1 1/4"		6
53035	110 x 1 1/2"		6
53036	110 x 2"		6
53143	125 x 3/4"		6
53144	125 x 1"		6
53145	125 x 1 1/4"		6
53146	125 x 1 1/2"		6
53147	125 x 2"		6



Collarín 4 tornillos reforzado / Colarinho 4 parafusos reforçado

Ref.		€/Un.	
53166	63 x 1/2"		35
53167	63 x 3/4"		35
53168	63 x 1"		35
53169	63 x 1 1/4"		35
53170	63 x 1 1/2"		35
53171	75 x 1/2"		20
53172	75 x 3/4"		20
53173	75 x 1"		20
53174	75 x 1 1/4"		20
53175	75 x 1 1/2"		20
53176	75 x 2"		20
53177	90 x 1/2"		15
53178	90 x 3/4"		15
53179	90 x 1"		15
53180	90 x 1 1/4"		15
53181	90 x 1 1/2"		15
53182	90 x 2"		15
53183	110 x 1/2"		6
53184	110 x 3/4"		6
53185	110 x 1"		6
53186	110 x 1 1/4"		6
53187	110 x 1 1/2"		6
53188	110 x 2"		6
53189	125 x 3/4"		6
53190	125 x 1"		6
53191	125 x 1 1/4"		6
53192	125 x 1 1/2"		6
53193	125 x 2"		6



Collarín 6 tornillos / Colarinho 6 parafusos

Ref.		€/Un.	
53148	140 x 1"		6
53149	140 x 1 1/4"		6
53150	140 x 1 1/2"		6
53151	140 x 2"		6
53152	160 x 1"		4
53153	160 x 1 1/4"		4
53154	160 x 1 1/2"		4
53155	160 x 2"		4



Collarín 6 tornillos reforzado / Colarinho 6 parafusos reforçado

Ref.		€/Un.	
53194	140 x 1"		6
53195	140 x 1 1/4"		6
53196	140 x 1 1/2"		6
53197	140 x 2"		6
53198	160 x 1"		4
53199	160 x 1 1/4"		4
53200	160 x 1 1/2"		4
53201	160 x 2"		4



# 2.6

## Acessórios de Latão p/ Canalização

Accesórios Latón p/ Canalización  
Brass Fittings f/ Plumbing  
Raccords en Laiton p/ Plomberie





# Acessórios de Latão p/ Canalização

Accesórios Latón p/ Canalización | Brass Fittings f/ Plumbing | Raccords en Laiton p/ Plomberie



600  
Joelho 90° F/F  
Elbow 90° F/F

Codo 90° H/H  
Coude 90° F/F

Ref.		€/Un.		
0600.0001	1/4	1,10 €	10	100
0600.0002	3/8	1,10 €	10	200
0600.0003	1/2	1,10 €	10	350
0600.0004	3/4	1,53 €	10	250
0600.0005	1	2,42 €	10	175
0600.0006	1 1/4	3,88 €	5	100
0600.0007	1 1/2	5,07 €	5	65
0600.0008	2	8,05 €	5	35
0600.0009	2 1/2	13,62 €	1	20
0600.0010	3	24,02 €	1	10
0600.0011	4	65,68 €	1	10

### Cromo/Cromado/Chrome/Chrome

0600.0102	3/8	1,44 €	10	200
0600.0103	1/2	1,44 €	10	350
0600.0104	3/4	1,93 €	10	250



601  
Joelho 90° Redução F/F  
Reducing Elbow 90° F/F

Codo 90° Red. H/H  
Coude 90° Réduction F/F

Ref.		€/Un.		
0601.0003	3/4x1/2	1,53 €	10	250
0601.0013	1x1/2	2,18 €	10	275
0601.0014	1x3/4	2,18 €	10	250
0601.0023	1 1/4x1/2	3,37 €	5	150
0601.0024	1 1/4x3/4	3,37 €	5	175
0601.0025	1 1/4x1	3,37 €	5	150
0601.0033	1 1/2x1/2	3,24 €	5	100
0601.0034	1 1/2x3/4	5,05 €	5	100
0601.0035	1 1/2x1	5,05 €	5	100
0601.0036	1 1/2x1 1/4	5,05 €	5	75
0601.0044	2x3/4	6,00 €	5	100
0601.0045	2x1	6,00 €	5	80
0601.0046	2x1 1/4	6,00 €	5	60
0601.0047	2x1 1/2	6,00 €	5	50
0601.0057	2 1/2x2	14,13 €	5	20



602  
Joelho 90° M/F  
Elbow 90° M/F

Codo 90° M/H  
Coude 90° M/F

Ref.		€/Un.		
0602.0000	3/8	1,16 €	10	200
0602.0003	1/2	1,16 €	10	350
0602.0004	3/4	1,62 €	10	250
0602.0005	1	2,41 €	10	200
0602.0006	1 1/4	3,97 €	5	100
0602.0007	1 1/2	4,94 €	5	75
0602.0008	2	7,73 €	5	40
0602.0009	2 1/2	16,48 €	1	15
0602.0010	3	27,91 €	1	10

### Cromo/Cromado/Chrome/Chrome

0602.0103	1/2	1,59 €	10	200
0602.0104	3/4	1,81 €	10	350



604  
Joelho c/ Pater F/F  
Wall Plated Elbow F/F

Codo Mural H/H  
Coude Murale F/F

Ref.		€/Un.		
0604.0003	1/2	2,89 €	10	120
0604.0004	3/4	3,85 €	10	150
0604.0005	1	5,00 €	10	100

### Cromo/Cromado/Chrome/Chrome

0604.0103	1/2	3,91 €	10	120
0604.0104	3/4	5,25 €	10	150



605  
Joelho 3 Vias  
Elbow 3 Ways

Codo 3 Vias  
Coude 3 Voies

Ref.		€/Un.		
0605.0003	1/2	2,38 €	10	125
0605.0004	3/4	3,05 €	10	150
0605.0005	1	3,97 €	10	90

### Cromo/Cromado/Chrome/Chrome

0605.0103	1/2	3,52 €	10	125
0605.0104	3/4	4,04 €	10	150



608  
Tê Simples F/F  
Equal Tee F/F

Te Igual H/H  
Té Egal F/F

Ref.		€/Un.		
0608.0000	1/4	1,50 €	10	100
0608.0001	3/8	1,50 €	10	150
0608.0003	1/2	1,47 €	10	250
0608.0004	3/4	2,05 €	10	100
0608.0005	1	2,99 €	10	120
0608.0006	1 1/4	5,05 €	5	60
0608.0007	1 1/2	7,12 €	5	40
0608.0008	2	9,37 €	5	20
0608.0009	2 1/2	17,90 €	1	12
0608.0010	3	32,96 €	1	10
0608.0011	4	78,80 €	1	9

### Cromo/Cromado/Chrome/Chrome

0608.0103	1/2	1,90 €	10	250
0608.0104	3/4	2,77 €	10	150
0608.0105	1	3,52 €	10	120



610  
Tê Simples M/F  
Equal Tee M/F

Te Igual M/H  
Té Egal M/F

Ref.		€/Un.		
0610.0004	3/4x3/4	2,53 €	10	150



612  
Tê 3 Vias M  
3 Ways Tee M

Te 3 Vias M  
Raccord 3 Voies M

Ref.		€/Un.		
0612.0101	1/4x1/4x1/2	1,35 €	10	

# Acessórios de Latão p/ Canalização

Accesórios Latón p/ Canalización | Brass Fittings f/ Plumbing | Raccords en Laiton p/ Plomberie



609  
Tê Redução F/F  
Reducing Tee F/F

Te Reducida H/H  
Té Réduit F/F

Ref.		€/Un.		
0609.0003	1/2x3/4x1/2	3,00 €	10	150
0609.0004	3/4x1/2x1/2	3,00 €	10	200
0609.0005	3/4x1/2x3/4	2,05 €	10	200
0609.0006	3/4x3/4x1/2	3,54 €	10	150
0609.0013	1x1/2	2,87 €	10	150
0609.0014	1x3/4	2,87 €	5	120
0609.0023	11/4x1/2	4,39 €	5	80
0609.0024	11/4x3/4	4,39 €	5	80
0609.0025	11/4x1	4,39 €	5	70
0609.0033	11/2x1/2	5,41 €	5	60
0609.0034	11/2x3/4	5,41 €	5	60
0609.0035	11/2x1	5,41 €	5	60
0609.0036	11/2x11/4	5,49 €	5	50
0609.0044	2x3/4	9,37 €	1	35
0609.0045	2x1	9,37 €	1	35
0609.0046	2x11/4	9,37 €	1	30
0609.0047	2x11/2	9,42 €	1	30
0609.0054	21/2x3/4	20,00 €	1	15
0609.0055	21/2x1	20,00 €	1	15
0609.0056	21/2x11/4	20,00 €	1	15
0609.0057	21/2x11/2	20,00 €	1	15
0609.0058	21/2x2	20,00 €	1	15
0609.0065	3x1	36,05 €	1	10
0609.0066	3x11/4	36,05 €	1	10
0609.0067	3x11/2	41,20 €	1	10
0609.0068	3x2	41,20 €	1	10

Cromo/Cromado/Chrome/Chrome

0609.0105	3/4x1/2x3/4	2,58 €	10	200
-----------	-------------	--------	----	-----



611  
Tê 5 Vias  
5 Ways Tee

Te 5 Vias  
Raccord 5 Voies

Ref.		€/Un.		
0611.0000	normal	5,59 €	5	80
0611.0002	comprido	7,21 €	5	50



614  
Casquilho M/M  
Hexagon Nipple M/M

Machón M/M  
Mamelon M/M

Ref.		€/Un.		
0614.0001	1/4	0,60 €	10	500
0614.0002	3/8	0,48 €	25	750
0614.0003	1/2	0,58 €	25	500
0614.0004	3/4	0,78 €	25	350
0614.0005	1	1,40 €	10	300
0614.0006	11/4	2,07 €	5	225
0614.0007	11/2	2,86 €	5	150
0614.0008	2	4,07 €	5	100
0614.0009	21/2	8,25 €	1	45
0614.0010	3	11,28 €	1	30
0614.0011	4	35,48 €	1	12

Cromo/Cromado/Chrome/Chrome

0614.0103	1/2	0,80 €	10	750
0614.0104	3/4	0,90 €	10	350



611F  
Tê 3 Vias  
3 Ways Tee

Te 3 Vias  
Raccord 3 Voies

Ref.		€/Un.		
0611.0502	1/4x1/2 40	4,20 €	10	100



618  
União Cruzamento F/F  
Bypass Bend F/F

Salto Puente H/H  
Courbe Deviation F/F

Ref.		€/Un.		
0618.0003	1/2	3,19 €	10	100
0618.0004	3/4	4,71 €	10	100
0618.0005	1	6,33 €	10	65



615  
Casquilho Red. M/M  
Reducing Nipple M/M

Machón Reducción M/M  
Mamelon Réduction M/M

Ref.		€/Un.		
0615.0001	3/8x1/4	0,80 €	20	600
0615.0002	1/2x1/4	0,90 €	10	600
0615.0003	1/2x3/8	0,58 €	25	600
0615.0013	3/4x1/2	0,80 €	25	400
0615.0023	1x1/2	1,30 €	10	200
0615.0024	1x3/4	1,30 €	10	350
0615.0033	11/4x1/2	2,20 €	5	150
0615.0034	11/4x3/4	2,20 €	5	150
0615.0035	11/4x1	2,20 €	5	250
0615.0043	11/2x1/2	2,86 €	5	100
0615.0044	11/2x3/4	2,86 €	5	100
0615.0045	11/2x1	3,45 €	5	100
0615.0046	11/2x11/4	3,30 €	5	175
0615.0054	2x3/4	4,62 €	5	125
0615.0055	2x1	4,62 €	5	125
0615.0056	2x11/4	4,62 €	5	100
0615.0057	2x11/2	4,62 €	5	100
0615.0065	21/2x1	10,00 €	5	60
0615.0066	21/2x11/4	10,00 €	1	60
0615.0067	21/2x11/2	10,00 €	1	60
0615.0068	21/2x2	10,00 €	1	60
0615.0069	3x1	20,00 €	1	30
0615.0076	3x11/4	20,00 €	1	30
0615.0077	3x11/2	20,00 €	1	30
0615.0078	3x2	11,02 €	1	30
0615.0079	3x21/2	13,91 €	1	30
0615.0088	4x2	36,05 €	1	25
0615.0089	4x21/2	36,05 €	1	25
0615.0090	4x3	36,05 €	1	15

Cromo/Cromado/Chrome/Chrome

0615.0103	1/2x3/8	0,72 €	10	600
0615.0113	3/4x1/2	1,08 €	10	400
0615.0124	1x3/4	1,51 €	10	350

# Acessórios de Latão p/ Canalização

Accesórios Latón p/ Canalización | Brass Fittings f/ Plumbing | Raccords en Laiton p/ Plomberie



616  
Casquilho Redução M/F Tuerca Reducción M/H  
Reducing Bushing M/F Mamelon Réduction M/F

Ref.		€/Un.		
0616.0001	3/8x1/4	0,50 €	10	500
0616.0002	1/2x1/4	0,60 €	10	500
0616.0003	1/2x3/8	0,41 €	25	750
0616.0013	3/4x1/2	0,60 €	25	500
0616.0023	1x1/2	1,25 €	10	300
0616.0024	1x3/4	0,91 €	10	300
0616.0033	11/4x1/2	1,92 €	5	225
0616.0034	11/4x3/4	1,92 €	5	225
0616.0035	11/4x1	1,46 €	5	225
0616.0043	11/2x1/2	2,81 €	5	175
0616.0044	11/2x3/4	2,64 €	5	175
0616.0045	11/2x1	2,64 €	5	175
0616.0046	11/2x11/4	1,95 €	5	175
0616.0053	2x1/2	3,81 €	5	100
0616.0054	2x3/4	3,81 €	5	100
0616.0055	2x1	3,81 €	5	100
0616.0056	2x11/4	3,81 €	5	100
0616.0057	2x11/2	3,14 €	5	100
0616.0064	21/2x3/4	10,00 €	1	50
0616.0065	21/2x1	10,00 €	1	50
0616.0066	21/2x11/4	10,00 €	1	50
0616.0067	21/2x11/2	9,00 €	1	50
0616.0068	21/2x2	9,00 €	1	50
0616.0075	3x1	13,50 €	1	30
0616.0076	3x11/4	12,88 €	1	30
0616.0077	3x11/2	11,33 €	1	30
0616.0078	3x2	11,33 €	1	30
0616.0079	3x21/2	11,33 €	1	30
0616.0087	4x11/2	35,00 €	1	25
0616.0088	4x2	35,00 €	1	25
0616.0089	4x21/2	35,00 €	1	25
0616.0090	4x3	35,00 €	1	25

Cromo/Cromado/Chrome/Chrome				
0616.0103	1/2x3/8	0,62 €	10	750
0616.0113	3/4x1/2	0,77 €	10	500
0616.0123	1x1/2	1,70 €	10	300



619  
União F/F Manguito H/H  
Socket F/F Manchon F/F

Ref.		€/Un.		
0619.0001	1/4	1,00 €	10	150
0619.0002	3/8	1,00 €	10	150
0619.0003	1/2	1,00 €	10	400
0619.0004	3/4	1,16 €	10	300
0619.0005	1	1,80 €	10	200
0619.0006	11/4	2,98 €	5	125
0619.0007	11/2	3,71 €	5	100
0619.0008	2	5,82 €	5	50
0619.0009	21/2	8,55 €	1	30
0619.0010	3	13,70 €	1	20
0619.0011	4	40,17 €	1	10

Cromo/Cromado/Chrome/Chrome				
0619.0103	1/2	1,22 €	10	400
0619.0104	3/4	1,52 €	10	300



621  
União M/F Manguito M/H  
Socket M/F Manchon M/F

Ref.		€/Un.		
0621.0003	1/2	0,81 €	25	400
0621.0004	3/4	1,28 €	25	250
0621.0005	1	2,01 €	10	150
0621.0006	11/4	3,89 €	5	150
0621.0007	11/2	4,32 €	5	125
0621.0008	2	6,28 €	5	75

Cromo/Cromado/Chrome/Chrome				
0621.0103	1/2	1,03 €	10	400
0621.0104	3/4	1,52 €	10	250



620  
União Redução F/F Manguito Reducción H/H  
Reducing Socket F/F Manchon Réduction F/F

Ref.		€/Un.		
0620.0002	1/2x3/8	1,50 €	10	250
0620.0003	3/4x1/2	1,16 €	25	250
0620.0013	1x1/2	1,85 €	10	200
0620.0014	1x3/4	1,71 €	10	150
0620.0023	11/4x1/2	3,42 €	5	125
0620.0024	11/4x3/4	2,94 €	5	125
0620.0025	11/4x1	2,94 €	5	175
0620.0033	11/2x1/2	4,43 €	5	125
0620.0034	11/2x3/4	4,43 €	5	125
0620.0035	11/2x1	3,81 €	5	125
0620.0036	11/2x11/4	3,19 €	5	150
0620.0043	2x1/2	6,63 €	5	125
0620.0044	2x3/4	6,63 €	5	125
0620.0045	2x1	6,63 €	5	125
0620.0046	2x11/4	5,73 €	5	100
0620.0047	2x11/2	5,73 €	5	75
0620.0057	21/2x11/2	11,44 €	1	75
0620.0058	21/2x2	11,44 €	1	40
0620.0066	3x11/4	20,00 €	1	25
0620.0067	3x11/2	20,00 €	1	5
0620.0068	3x2	20,00 €	1	25
0620.0069	3x21/2	20,00 €	1	25
0620.0078	4x2	50,00 €	1	5
0620.0080	4x3	50,00 €	1	5



622  
União M/F Sextavada Manguito M/H Hex.  
Hexagon M/F Socket Manchon M/F Hex.

Ref.		€/Un.		
0622.0002	3/8	0,57 €	25	500
0622.0003	1/2	0,61 €	25	500
0622.0020	1/2 2 cm	0,93 €	25	300
0622.0004	3/4	0,95 €	10	300
0622.0005	1	1,29 €	10	175

Cromo/Cromado/Chrome/Chrome				
0622.0103	1/2	0,70 €	10	500
0622.0104	3/4	1,22 €	10	300



# Acessórios de Latão p/ Canalização

Accesorios Latón p/ Canalización | Brass Fittings f/ Plumbing | Raccords en Laiton p/ Plomberie



**622R**  
 União Red. M/F Sext. Manguito Red. M/H Hex.  
 Rdc. Hxg. M/F Socket Manchon Réduit M/F Hex.

Ref.		€/Un.		
0622.0010	1/2x3/8	<b>0,62 €</b>	25	500
0622.0013	1/2x3/4	<b>0,98 €</b>	25	200
0622.0014	3/4x1	<b>1,30 €</b>	25	200



**625**  
 Junção Cônica F/F Manguito Cônico H/H  
 Conic Socket F/F Manchon conique F/F

Ref.		€/Un.		
0625.0003	1/2	<b>3,30 €</b>	10	200
0625.0004	3/4	<b>4,01 €</b>	10	120
0625.0005	1	<b>5,17 €</b>	10	80
0625.0006	1 1/4	<b>7,50 €</b>	5	75
0625.0007	1 1/2	<b>9,20 €</b>	5	50
0625.0008	2	<b>13,10 €</b>	5	35
0625.0009	2 1/2	<b>36,57 €</b>	1	15
0625.0010	3	<b>44,65 €</b>	1	12
0625.0011	4	<b>180,00 €</b>	1	8

**Cromo/Cromado/Chrome/Chrome**

0625.0103	1/2	<b>4,12 €</b>	10	200
0625.0104	3/4	<b>5,30 €</b>	10	120



**627**  
 Taco M Tapón M  
 Plug M Bouchon M

Ref.		€/Un.		
0627.0000	1/4	<b>0,51 €</b>	10	500
0627.0002	3/8	<b>0,40 €</b>	10	500
0627.0003	1/2	<b>0,40 €</b>	25	750
0627.0004	3/4	<b>0,70 €</b>	25	500
0627.0005	1	<b>1,10 €</b>	10	350
0627.0006	1 1/4	<b>1,73 €</b>	10	200
0627.0007	1 1/2	<b>2,06 €</b>	5	100
0627.0008	2	<b>3,14 €</b>	5	200
0627.0009	2 1/2	<b>8,24 €</b>	1	50
0627.0010	3	<b>12,98 €</b>	1	40
0627.0011	4	<b>25,75 €</b>	1	25

**Cromo/Cromado/Chrome/Chrome**

0627.0102	3/8	<b>0,62 €</b>	10	500
0627.0103	1/2	<b>0,66 €</b>	10	700
0627.0104	3/4	<b>1,00 €</b>	10	500



**623**  
 União Redução M/F Manguito Reducción M/H  
 Reducing Socket M/F Manchon Réduit M/F

Ref.		€/Un.		
0623.0003	3/4x1/2	<b>1,15 €</b>	25	300
0623.0013	1x1/2	<b>1,76 €</b>	10	200
0623.0014	1x3/4	<b>1,66 €</b>	10	200
0623.0023	1 1/4x1/2	<b>3,91 €</b>	5	125
0623.0024	1 1/4x3/4	<b>3,91 €</b>	5	125
0623.0025	1 1/4x1	<b>3,97 €</b>	5	125
0623.0033	1 1/2x1/2	<b>4,43 €</b>	5	150
0623.0034	1 1/2x3/4	<b>4,43 €</b>	5	150
0623.0035	1 1/2x1	<b>5,00 €</b>	5	150
0623.0036	1 1/2x1 1/4	<b>3,24 €</b>	5	125
0623.0043	2x1/2	<b>7,02 €</b>	5	125
0623.0044	2x3/4	<b>7,02 €</b>	5	125
0623.0045	2x1	<b>6,39 €</b>	5	125
0623.0046	2x1 1/4	<b>6,39 €</b>	5	120
0623.0047	2x1 1/2	<b>6,54 €</b>	5	100
0623.0051	2 1/2x1 1/2	<b>14,00 €</b>	1	30
0623.0052	2 1/2x2	<b>14,00 €</b>	1	30
0623.0068	3x2	<b>30,00 €</b>	1	15
0623.0080	4x3	<b>38,00 €</b>	1	10

**Cromo/Cromado/Chrome/Chrome**

0623.0103	3/4x1/2	<b>1,55 €</b>	10	300
0623.0114	1x3/4	<b>2,01 €</b>	10	200



**626**  
 Junção Cônica M/F Manguito Cônico M/H  
 Conic Socket M/F Manchon conique M/F

Ref.		€/Un.		
0626.0003	1/2	<b>4,43 €</b>	10	175
0626.0004	3/4	<b>5,50 €</b>	10	100
0626.0005	1	<b>6,77 €</b>	10	75
0626.0006	1 1/4	<b>8,43 €</b>	5	60
0626.0007	1 1/2	<b>11,20 €</b>	5	40
0626.0008	2	<b>14,00 €</b>	5	30
0626.0009	2 1/2	<b>45,00 €</b>	1	15



**626M**  
 Junção Cônica M/M Manguito Cônico MM  
 Conic Socket M/M Manchon conique M/M

Ref.		€/Un.		
0626.0104	3/4	<b>6,00 €</b>	5	75



**628**  
 Taco F Tapón F  
 Plug F Bouchon F

Ref.		€/Un.		
0628.0001	1/4	<b>0,41 €</b>	10	500
0628.0002	3/8	<b>0,48 €</b>	10	500
0628.0003	1/2	<b>0,41 €</b>	25	750
0628.0004	3/4	<b>0,57 €</b>	25	500
0628.0005	1	<b>0,95 €</b>	10	350
0628.0006	1 1/4	<b>1,84 €</b>	10	200
0628.0007	1 1/2	<b>2,39 €</b>	5	150
0628.0008	2	<b>3,22 €</b>	5	100
0628.0009	2 1/2	<b>9,25 €</b>	1	50
0628.0010	3	<b>12,77 €</b>	1	30

**Cromo/Cromado/Chrome/Chrome**

0628.0102	3/8	<b>0,51 €</b>	10	500
0628.0103	1/2	<b>0,63 €</b>	10	750
0628.0104	3/4	<b>0,89 €</b>	10	500

# Acessórios de Latão p/ Canalização

Accesórios Latón p/ Canalización | Brass Fittings f/ Plumbing | Raccords en Laiton p/ Plomberie



629  
Cruzeta  
Cross

Cruz  
Croix

Ref.		€/Un.		
0629.0003	1/2	<b>2,52 €</b>	10	150
0629.0004	3/4	<b>3,50 €</b>	10	150
0629.0005	1	<b>4,94 €</b>	10	90
0629.0006	1 1/4	<b>8,34 €</b>	5	50
0629.0007	1 1/2	<b>10,15 €</b>	5	35
0629.0008	2	<b>16,48 €</b>	5	20



631-45  
Curva 45° F/F  
Bend 45° F/F

Curva 45° H/H  
Courbe 45° F/F

Ref.		€/Un.		
0631.0023	1/2	<b>4,12 €</b>	10	175
0631.0024	3/4	<b>5,10 €</b>	10	100
0631.0025	1	<b>7,42 €</b>	10	100
0631.0026	1 1/4	<b>10,82 €</b>	5	50
0631.0027	1 1/2	<b>15,20 €</b>	5	40
0631.0028	2	<b>25,03 €</b>	5	20



632-45  
Curva 45° M/F  
Bend 45° M/F

Curva 45° M/H  
Courbe 45° M/F

Ref.		€/Un.		
0632.0023	1/2	<b>4,12 €</b>	10	225
0632.0024	3/4	<b>5,15 €</b>	10	125
0632.0025	1	<b>7,52 €</b>	10	125
0632.0026	1 1/4	<b>11,33 €</b>	5	60
0632.0027	1 1/2	<b>15,45 €</b>	5	50
0632.0028	2	<b>25,24 €</b>	5	25



630  
Batente  
Nut

Tuerca  
Écrou

Ref.		€/Un.		
0630.0003	1/2	<b>0,88 €</b>	10	600
0630.0004	3/4	<b>0,98 €</b>	10	500
0630.0005	1	<b>1,22 €</b>	10	300
0630.0006	1 1/4	<b>1,41 €</b>	5	250
0630.0007	1 1/2	<b>1,91 €</b>	5	200
0630.0008	2	<b>3,61 €</b>	5	150
0630.0009	2 1/2	<b>8,91 €</b>	1	50



631  
Curva 90° F/F  
Bend 90° F/F

Curva 90° H/H  
Courbe 90° F/F

Ref.		€/Un.		
0631.0003	1/2	<b>3,62 €</b>	10	125
0631.0004	3/4	<b>4,62 €</b>	10	100
0631.0005	1	<b>6,16 €</b>	10	70
0631.0006	1 1/4	<b>11,44 €</b>	5	30
0631.0007	1 1/2	<b>13,42 €</b>	5	25
0631.0008	2	<b>22,00 €</b>	5	12
0631.0009	2 1/2	<b>41,20 €</b>	1	6
0631.0010	3	<b>77,25 €</b>	1	5



632  
Curva 90° M/F  
Bend 90° M/F

Curva 90° M/H  
Courbe 90° M/F

Ref.		€/Un.		
0632.0003	1/2	<b>3,62 €</b>	10	175
0632.0004	3/4	<b>4,44 €</b>	10	175
0632.0005	1	<b>5,84 €</b>	10	75
0632.0006	1 1/4	<b>10,75 €</b>	5	40
0632.0007	1 1/2	<b>12,59 €</b>	5	25
0632.0008	2	<b>22,00 €</b>	5	14
0632.0009	2 1/2	<b>40,17 €</b>	1	7
0632.0010	3	<b>77,25 €</b>	1	5



634  
Curva F c/ Junção  
Long Bend F w/ H.C.

Curva H c/ Racor  
Courbe GR F a/ R.

Ref.		€/Un.		
0634.0005	1	<b>12,10 €</b>	5	50
0634.0006	1 1/4	<b>14,01 €</b>	5	25
0634.0007	1 1/2	<b>20,60 €</b>	5	20
0634.0008	2	<b>36,05 €</b>	5	8



650S  
Agulheta Simples  
Nozzle

Lanza Manguera  
Lance

Ref.		€/Un.		
0650.0003	1/2	<b>3,64 €</b>	5	100
0650.0004	3/4	<b>3,76 €</b>	5	100
0650.0005	1	<b>8,00 €</b>	5	50



650R  
Agulheta Regulável  
Adjustable Nozzle

Lanza Regulable  
Lance Réglable

Ref.		€/Un.		
0650.0203	1/2	<b>4,93 €</b>	5	100
0650.0204	3/4	<b>5,04 €</b>	5	100

# Acessórios de Latão p/ Canalização

Accesorios Latón p/ Canalización | Brass Fittings f/ Plumbing | Raccords en Laiton p/ Plomberie



660  
Canhão M p/ Plástico  
Hexagon Hose Cannon M

Entronque Manguera M  
Manchon Arrosage M

Ref.		€/Un.		
0660.0002	3/8	1,19 €	10	400
0660.0003	1/2	1,00 €	10	400
0660.0004	3/4	1,30 €	10	250
0660.0005	1	1,70 €	10	250
0660.0006	1 1/4	2,70 €	5	125
0660.0007	1 1/2	3,50 €	5	80
0660.0008	2	5,50 €	5	50
0660.0009	2 1/2	9,00 €	1	20
0660.0010	3	16,00 €	1	15
0660.0011	4	38,00 €	1	10



662  
Canhão F p/ Plástico  
Hexagon Hose Cannon F

Entronque Manguera F  
Manchon Arrosage F

Ref.		€/Un.		
0662.0002	3/8	1,76 €	10	200
0662.0003	1/2	1,10 €	10	400
0662.0004	3/4	1,44 €	10	250
0662.0005	1	2,06 €	10	225
0662.0006	1 1/4	2,94 €	5	125
0662.0007	1 1/2	3,61 €	5	90
0662.0008	2	5,15 €	5	50
0662.0009	2 1/2	11,44 €	1	20
0662.0010	3	20,60 €	1	10
0662.0011	4	60,77 €	1	5



663  
Canhão Duplo  
Double Hose Connector

Entronque Mang. Doble  
Double Manchon Arr.

Ref.		€/Un.		
0663.0002	3/8	1,55 €	10	100
0663.0003	1/2	1,77 €	10	300
0663.0004	3/4	2,16 €	10	300
0663.0005	1	3,09 €	10	175
0663.0006	1 1/4	3,19 €	5	100
0663.0007	1 1/2	4,12 €	5	75
0663.0008	2	5,15 €	5	50
0663.0009	2 1/2	12,00 €	1	25
0663.0010	3	20,00 €	1	15
0663.0011	4	50,00 €	1	5



660C  
Canhão M Comprido  
Hose M Long Hxg. Cnn.

Entr. Mang. M Largo  
Manchon Arros. M Long

Ref.		€/Un.		
0660.0015	1	3,61 €	10	125
0660.0016	1 1/4	3,71 €	5	75
0660.0017	1 1/2	5,15 €	5	60
0660.0018	2	8,24 €	5	30



664  
Canhão Dep. p/ Plástico  
Tank Connector

Salida Tanque  
Cuve Sortie Connecteur

Ref.		€/Un.		
0664.0003	1/2	2,83 €	10	200
0664.0004	3/4	3,30 €	10	200
0664.0005	1	4,53 €	10	125
0664.0006	1 1/4	6,18 €	5	75
0664.0007	1 1/2	8,24 €	5	50
0664.0008	2	11,79 €	5	30
0664.0009	2 1/2	33,99 €	1	15
0664.0010	3	39,14 €	1	10



666  
Canhão Depósito R/R  
Double Tank Connector

Racor Doble c/ Tuerca  
Double Cuve Sortie

Ref.		€/Un.		
0666.0003	1/2	3,30 €	10	200
0666.0004	3/4	4,33 €	10	200
0666.0005	1	5,25 €	10	125
0666.0006	1 1/4	8,19 €	5	75
0666.0007	1 1/2	10,30 €	5	50
0666.0008	2	14,47 €	5	30
0666.0009	2 1/2	39,66 €	1	15
0666.0010	3	41,72 €	1	10



665  
Canhão Dep. Ferro  
Tank Outlet Connector

Racor c/ Tuerca Corredora  
Cuve Sortier Connecteur

Ref.		€/Un.		
0665.0003	3/4x1/2	3,20 €	10	300
0665.0004	1x3/4	4,12 €	10	175
0665.0005	1 1/4x1	5,93 €	5	100
0665.0006	1 1/2x1 1/4	7,47 €	5	80
0665.0007	2x1 1/2	10,20 €	5	50
0665.0008	2 1/2x1 1/2	23,84 €	1	10



670M  
Meia Junção c/ Borracha  
2P F Hose Connector

Racor 2P H p/ Mang.  
Raccord 2P F Arros.

Ref.		€/Un.		
0670.0015	1	4,22 €	10	200
0670.0016	1 1/4	5,00 €	5	175
0670.0017	1 1/2	7,00 €	5	150

# Acessórios de Latão p/ Canalização

Accesórios Latón p/ Canalización | Brass Fittings f/ Plumbing | Raccords en Laiton p/ Plomberie



670  
Junção p/ Motor M  
Motor Con.Hose M

Unión Motor Mang. M  
Union Moteur Arr. M

Ref.		€/Un.		
0670.0004	3/4	5,00 €	10	120
0670.0005	1	6,40 €	10	120
0670.0006	11/4	7,70 €	5	75
0670.0007	11/2	10,70 €	5	45
0670.0008	2	17,50 €	5	25
0670.0009	21/2	28,00 €	1	15
0670.0010	3	40,00 €	1	9
0670.0011	4	159,65 €	1	5



671  
Junção Dupla P/P  
3P F Hose Mender

Raccord 3P Arrosage  
Union Moteur Arr. M

Ref.		€/Un.		
0671.0004	3/4	6,64 €	10	100
0671.0005	1	7,21 €	10	100
0671.0006	11/4	8,24 €	5	50
0671.0007	11/2	11,23 €	5	35
0671.0008	2	16,48 €	5	15
0671.0009	21/2	32,96 €	1	10
0671.0010	3	47,38 €	1	5
0671.0011	4	149,35 €	1	2



672  
Junção p/ Motor M/F  
Motor Connector M/F

Unión Motor M/F  
Union Moteur M/F

Ref.		€/Un.		
0672.0003	1/2	5,15 €	5	150
0672.0004	3/4	6,18 €	5	100
0672.0005	1	8,01 €	5	75
0672.0006	11/4	10,30 €	5	60
0672.0007	11/2	13,97 €	1	40
0672.0008	2	16,03 €	1	30
0672.0009	21/2	57,68 €	1	15
0672.0010	3	80,34 €	1	10



673  
Junção p/ Motor F/F  
Motor Connector F/F

Unión Motor H/H  
Union Moteur F/F

Ref.		€/Un.		
0673.0004	3/4	6,18 €	10	120
0673.0005	1	7,66 €	10	80
0673.0006	11/4	9,61 €	5	75
0673.0007	11/2	12,57 €	5	50
0673.0008	2	13,73 €	5	35
0673.0009	21/2	57,68 €	1	15



674  
Junção p/ M Plást. F  
Motor Connect. Hose F

Unión Motor Mang. H  
Union Moteur Arros. F

Ref.		€/Un.		
0674.0004	3/4	6,75 €	10	120
0674.0005	1	7,59 €	10	120
0674.0006	11/4	8,19 €	5	75
0674.0007	11/2	12,88 €	5	45
0674.0008	2	17,51 €	5	25
0674.0009	21/2	32,96 €	1	15



641  
Copo p/ Motor  
Motor Fitting

Racor p/Motor  
Raccord p/ Motor

Ref.		€/Un.		
0641.0001	3/8	5,30 €	10	50



696  
Ralo Mina s/ Canhão  
Strainer

Valvula Mina  
Crépine

Ref.		€/Un.		
0696.0004	3/4	4,00 €	12	128
0696.0005	1	5,00 €	4	72
0696.0006	11/4	7,00 €	5	60
0696.0007	11/2	10,50 €	2	36
0696.0008	2	11,50 €	5	20



685  
Válvula Fundo Poço F  
Bottom Valve F

Válvula de Fundo H  
Crépine a Clapete F

Ref.		€/Un.		
0685.0004	3/4	12,15 €	12	30
0685.0005	1	12,15 €	10	30
0685.0006	11/4	14,42 €	8	35
0685.0007	11/2	17,72 €	5	20
0685.0008	2	23,69 €	4	15
0685.0009	21/2	47,38 €	2	5
0685.0010	3	66,95 €	1	5
0685.0011	4	180,25 €	1	2



686  
Válvula Fundo Poço c/ Canhão  
Válvula de Fundo c/ Entronque  
Bottom Valve w/ Hose Connector  
Crépine à Clapete Arrosage

Ref.		€/Un.		
0686.0004	3/4	11,00 €	12	25
0686.0005	1	11,00 €	10	25
0686.0006	11/4	14,00 €	5	30
0686.0007	11/2	19,00 €	2	15
0686.0008	2	24,00 €	1	12
0686.0009	21/2	50,00 €	1	5
0686.0010	3	77,25 €	1	5



# Torneiras e bebedouros

Grifos e Bebedoro | Bibcocks and Drinking Taps | Robinets



713R  
Torneira Decorativa - Rã  
Grifo Decorativo - Rana  
Ornamental Bibcock - Frog  
Robinet Ornementaux - Grenouille

Ref.		€/Un.		
0713.0320	1/2x3/4	24,00 €	1	24



713P  
Torneira Decorativa - Pato  
Grifo Decorativo - Pato  
Ornamental Bibcock - Duck  
Robinet Ornementaux - Canard

Ref.		€/Un.		
0713.0310	1/2x3/4	24,00 €	1	24



713X  
Torneira Decorativa - Peixe  
Grifo Decorativo - Pez  
Ornamental Bibcock - Fish  
Robinet Ornementaux - Poisson

Ref.		€/Un.		
0713.0315	1/2x3/4	24,00 €	1	24



713G  
Torneira Decorativa - Galo  
Grifo Decorativo - Gallo  
Ornamental Bibcock - Rooster  
Robinet Ornementaux - Coq

Ref.		€/Un.		
0713.0305	1/2x3/4	24,00 €	1	24



710  
Torneira Válvula Grifo Jardín Simple  
Simple Garden Bibcock Robinet Simple

Ref.		€/Un.		
0710.0003	1/2	6,00 €	5	50
0710.0004	3/4	7,50 €	5	25
0710.0005	1	12,36 €	1	15

Cromo/Cromado/Chrome/Chrome				
0710.0103	1/2	6,70 €	5	50
0710.0104	3/4	8,24 €	5	25
0710.0105	1	14,42 €	1	15



713  
Torneira c/ Junção Grifo c/ Racor Manguera  
Bibcock w/ Hose Connector Robinet a/ Raccord

Ref.		€/Un.		
0713.0004	1/2x3/4	6,50 €	5	50
0713.0005	3/4x1	9,60 €	5	25
0713.0016	1x11/4	15,00 €	1	-
0713.0027	11/4x11/2	43,26 €	1	-

Cromo/Cromado/Chrome/Chrome				
0713.0104	1/2x3/4	7,50 €	5	50
0713.0105	3/4x1	10,30 €	5	25
0713.0116	1x11/4	17,00 €	1	10



714  
Torn. c/ Junção Chave Segredo Grifo c/Llave  
Secret Key Bibcock Robinet Jardín Clé

Ref.		€/Un.		
0714.0004	1/2x3/4	8,50 €	5	50
0714.0005	3/4x1	13,50 €	5	25

Cromo/Cromado/Chrome/Chrome				
0714.0104	1/2x3/4	11,00 €	5	50
0714.0105	3/4x1	16,00 €	5	25



716  
Torn. Pistão Fontanário Grifo Pulsante Fuente  
Fountain Tap Robinet Fount. a/ poussoir

Ref.		€/Un.		
0716.0003	1/2	17,90 €	1	
0716.0004	3/4	24,00 €	1	
0716.0005	1	27,00 €	1	



799BA  
Bebedouro c/ Alavanca Bebedero  
Fountain tap Robinet Fontaine

Ref.		€/Un.		
0799.0101	1/2	61,62 €	1	

# Válvulas e Componentes

Válvulas e Acessórios | Valves and Parts | Vannes et Composants



752  
Castelo Chave Segredo  
Secret Key Head

Montra p/Llave  
Tête Cache

Ref.		€/Un.		
0752.0401	1/2	3,30 €	5	150
0752.0402	3/4	3,80 €	5	100



767  
Chave p/Torneira Segredo  
Bibcock Key

Llave Grifo  
Clé p/ Robinet

Ref.	€/Un.		
0767.0101	0,30 €	10	500



752CP  
Castelo Passador P. Fixo  
Head for Valve

Montura p/ Fijo  
Tête de Robinet

Ref.		€/Un.		
0752.0101	1/2	2,70 €	5	200
0752.0102	3/4	3,30 €	5	150



752CT  
Castelo Travinca  
Cross Head Valves

Montura c/ Cruceta  
Tête de Robinet Croix

Ref.		€/Un.		
0752.0801	1/2	3,20 €	10	200
0752.0802	3/4	3,50 €	10	200
0752.0803	1	6,20 €	5	75

Cromo/Cromado/Chrome/Chrome

0752.0811	1/2	4,25 €	10	200
0752.0812	3/4	4,75 €	10	200



675  
Junção p/Torneira  
Tap Hose Connector F

Racor Mangueira H  
Adaptateur Nez à Visser F

Ref.		€/Un.		
0675.0004	1/2x3/4	1,30 €	10	500
0675.0005	3/4x1	2,25 €	10	200
0675.0006	1x11/4	6,00 €	5	100

Cromo/Cromado/Chrome/Chrome

0675.0104	1/2x3/4	1,50 €	10	500
0675.0105	3/4x1	2,40 €	10	200
0675.0106	1x11/4	6,30 €	5	100



700  
Passador Válvula F/F  
Valve F/F

Llave Paso F/F  
Vanne F/F

Ref.		€/Un.		
0700.0003	1/2	4,80 €	5	100
0700.0004	3/4	6,20 €	5	50
0700.0005	1	10,80 €	5	25

Cromo/Cromado/Chrome/Chrome

0700.0103	1/2	6,03 €	5	100
0700.0104	3/4	7,73 €	5	50



701  
Passador Válvula Avença  
Valve F/F

Válvula F/F  
Vanne F/F

Ref.		€/Un.		
0701.0003	1/2	5,50 €	5	75
0701.0004	3/4	8,50 €	5	50
0701.0005	1	12,50 €	5	25



750  
Caixa Baixa Passador  
Valve Body

Cuerpo Baixa Passador  
Corp Clé

Ref.		€/Un.		
0750.0101	1/2	2,65 €	10	175
0750.0102	3/4	3,45 €	10	175
0750.0103	1	5,95 €	5	100



799BS  
Bebedouro p/ Suino  
Pigs' Drinking Tap

Bebedero Cerdos  
Buvette p/ Cochons

Ref.		€/Un.		
0799.0201	1/2	5,00 €	5	50

# 2.7

## Tube e Acessórios Multicamada

Tubería y Accesorios de Multicapa | Pipe and Multilayer Accessories | Tuyaux et Accessoires Multicouche



**Acessórios Latão CW617N**  
Accesorios Latón CW617N  
Brass Fittings CW617N  
Accessoires de Laiton CW617N

**Acessórios Duplo o-ring**  
Accesorios O-ring doble  
Double o-ring Accessories  
Accessoires O-ring double

**Água fria, AQS e aquecimento**  
Agua fría, ACS e aquecimento  
Cold water, DHW and heating  
Eau froide, ECS et chauffage

Sistema multicamada Isoltubex certificado por AENOR UNE EN ISO-21003  
(8 de Abril de 2010, nº contrato 001/000798, classe de aplicação 1/6, 2/6, 4/6, 5/6 e diâmetros 16, 20, 25, 32 e 40)

Sistema multicapa Isoltubex certificado por AENOR UNE EN ISO 21003  
(8 de abril de 2010, Contrato nº 001/000798, classe de aplicación 1/6, 2/6, 4/6, 5/6 y diâmetros de 16, 20, 25, 32 y 40)

Isoltubex multilayer system certified by AENOR UNE EN ISO 21003  
(April 8th, 2010, contract no. 001/000798, application class 1/6, 2/6, 4/6, 5/6 and diameters 16, 20, 25, 32 and 40)

Système multicouche Isoltubex certifié par AENOR UNE EN ISO 21003  
(8 Avril 2010, contrat nº 001/000798, classe d'application 1/6, 2/6, 4/6, 5/6 et des diamètres 16, 20, 25, 32 et 40)

### Tubagens certificadas por AENOR para:

Tubos certificados por AENOR para :  
Pipes certified by AENOR for:  
Tubes certifiés par AENOR pour:

**Classe 1**  
**Água quente 60°**  
Agua caliente 60°  
Hot water 60°  
Eau chaude 60°

**Classe 2**  
**Água quente 70°**  
Agua caliente 70°  
Hot water 70°  
Eau chaude 70°

**Classe 4**  
**Chão radiante e radiadores baixa temperatura**  
Suelo radiante y radiadores baja temperatura  
Floor heating and radiators low temperature  
Chauffage par le sol et radiateurs basse température

**Classe 5**  
**Aquecimento por radiadores alta temperatura**  
Calefacción por radiadores a alta temperatura  
Heating by radiators at high temperature  
Chauffage par radiateurs haute température



Tubo Pert-Al-Pert Rolo / Pert-Al-Pert Pipe Roll

Ref.		€/m	
0902.0003	16x2	<b>0,90 €</b>	100 m
0902.0009	20x2	<b>1,30 €</b>	100 m
0902.0013	25x2,5	<b>2,10 €</b>	50 m
0902.0014	32x3	<b>3,45 €</b>	50 m
0902.0002	16x2	<b>1,14 €</b>	25 m
0902.0008	20x2	<b>1,49 €</b>	25 m



Tubo Pert-Al-Pert Vara / Pert-Al-Pert Bar Pipe

Ref.		€/m	
0902.0101	16x2	<b>1,13 €</b>	200
0902.0103	20x2	<b>1,40 €</b>	140
0902.0104	25x2,5	<b>2,40 €</b>	80
0902.0105	32x3	<b>4,15 €</b>	64
0902.0106	40x4	<b>11,00 €</b>	64
0902.0107	50x4,5	<b>14,00 €</b>	16
0902.0108	63x6	<b>20,00 €</b>	12



Tubo Pert-Al-Pert Isolado / Insulated Pert-Al-Pert Pipe

Ref.			€/m	
0901.0001	16		<b>1,56 €</b>	50 m
0901.0002	16		<b>1,56 €</b>	50 m
0901.0005	20		<b>2,28 €</b>	50 m
0901.0006	20		<b>2,28 €</b>	50 m
0901.0007	25		<b>3,77 €</b>	25 m
0901.0008	25		<b>3,77 €</b>	25 m



União Simples / Union Igual

Ref.		€/Un.		
0903.0001	16	<b>1,80 €</b>	45	360
0903.0003	20	<b>2,50 €</b>	30	240
0903.0004	25	<b>4,80 €</b>	15	120
0903.0005	32	<b>6,20 €</b>	10	80
0903.0006	40	<b>16,50 €</b>	8	16
0903.0007	50	<b>21,00 €</b>	8	16
0903.0008	63	<b>52,00 €</b>	8	16



União Macho / Union Macho

Ref.		€/Un.		
0903.1101	16x3/8	<b>1,80 €</b>	50	400
0903.1102	16x1/2	<b>1,90 €</b>	50	400
0903.1103	16x3/4	<b>2,50 €</b>	40	320
0903.1106	20x1/2	<b>2,10 €</b>	40	320
0903.1107	20x3/4	<b>2,80 €</b>	35	280
0903.1108	20x1	<b>3,80 €</b>	24	192
0903.1109	25x1/2	<b>3,80 €</b>	20	160
0903.1110	25x3/4	<b>4,40 €</b>	18	144
0903.1111	25x1	<b>4,90 €</b>	16	128
0903.1112	32x3/4	<b>5,20 €</b>	12	96
0903.1113	32x1	<b>7,00 €</b>	14	112
0903.1114	32x1 1/4	<b>10,00 €</b>	8	64
0903.1115	40x1 1/4	<b>14,00 €</b>	8	16
0903.1117	50x1 1/4	<b>20,00 €</b>	8	16
0903.1118	50x1 1/2	<b>20,00 €</b>	8	16
0903.1119	63x1	<b>35,00 €</b>	8	16
0903.1120	63x1 1/4	<b>38,00 €</b>	8	16
0903.1121	63x1 1/2	<b>38,00 €</b>	8	16
0903.1122	63x2	<b>40,00 €</b>	8	16



União Fêmea / Union Hembra

Ref.		€/Un.		
0903.1201	16x1/2	<b>2,10 €</b>	40	320
0903.1202	16x3/4	<b>2,70 €</b>	30	240
0903.1205	20x1/2	<b>2,40 €</b>	35	280
0903.1206	20x3/4	<b>2,90 €</b>	30	240
0903.1207	20x1	<b>4,20 €</b>	20	160
0903.1208	25x1/2	<b>3,80 €</b>	20	160
0903.1209	25x3/4	<b>4,20 €</b>	20	160
0903.1210	25x1	<b>5,20 €</b>	12	96
0903.1211	32x3/4	<b>5,30 €</b>	16	128
0903.1212	32x1	<b>6,00 €</b>	12	96
0903.1213	40x1	<b>13,00 €</b>	8	16
0903.1214	40x1 1/4	<b>13,00 €</b>	8	16
0903.1215	40x1 1/2	<b>15,00 €</b>	8	16
0903.1216	50x1 1/4	<b>16,00 €</b>	8	16
0903.1217	50x1 1/2	<b>17,00 €</b>	8	16
0903.1218	50x2	<b>21,00 €</b>	8	16
0903.1219	63x2	<b>40,00 €</b>	8	16



União Porca Louca / Racor Móvil

Ref.		€/Un.		
0903.1301	16x1/2	<b>2,40 €</b>	48	384
0903.1302	16x3/4	<b>4,00 €</b>	30	240
0903.1305	20x1/2	<b>2,90 €</b>	30	240
0903.1306	20x3/4	<b>3,40 €</b>	24	192
0903.1307	20x1	<b>4,90 €</b>	20	160
0903.1308	25x1/2	<b>5,20 €</b>	20	160
0903.1309	25x3/4	<b>5,60 €</b>	18	144
0903.1310	25x1	<b>7,40 €</b>	14	112
0903.1311	32x1	<b>8,00 €</b>	14	112



# Acessórios Multicamada Press

Accesórios de Multicapa Press | Multilayer Press Accessories | Accessoires Multicouche Press



União Redução  
Reducing Union

Unión Reducción  
Raccord Réduit

Ref.		€/Un.		
0903.0102	20x16	<b>2,40 €</b>	37	296
0903.0104	25x16	<b>3,70 €</b>	20	160
0903.0106	25x20	<b>4,30 €</b>	20	160
0903.0107	32x16	<b>5,20 €</b>	15	120
0903.0109	32x20	<b>5,40 €</b>	12	96
0903.0110	32x25	<b>6,50 €</b>	12	96
0903.0111	40x25	<b>14,00 €</b>	8	16
0903.0112	40x32	<b>15,00 €</b>	8	16
0903.0113	50x32	<b>19,00 €</b>	8	16
0903.0114	50x40	<b>23,00 €</b>	8	16
0903.0115	63x40	<b>45,00 €</b>	8	16
0903.0116	63x50	<b>50,00 €</b>	8	16



Joelho 90°  
Elbow 90°

Codo 90°  
Coude 90°

Ref.		€/Un.		
0903.0201	16	<b>2,00 €</b>	32	256
0903.0203	20	<b>2,90 €</b>	22	176
0903.0204	25	<b>6,00 €</b>	11	88
0903.0205	32	<b>8,70 €</b>	6	48
0903.0206	40	<b>24,00 €</b>	8	16
0903.0207	50	<b>32,50 €</b>	8	16
0903.0208	63	<b>70,00 €</b>	8	16



Joelho C/Pater  
Wall Elbow

Codo Mural  
Coude Mural

Ref.		€/Un.		
0903.0801	16x1/2	<b>4,10 €</b>	14	112
0903.0803	20x1/2	<b>4,70 €</b>	12	96
0903.0804	20x3/4	<b>6,20 €</b>	10	80
0903.0805	25x3/4	<b>6,90 €</b>	10	80



Tê Redução  
Reducing Tee

Te Reducción  
Té Réduit

Ref.		€/Un.		
0903.0401	16x20x16	<b>3,40 €</b>	18	144
0903.0402	16x25x16	<b>5,20 €</b>	19	152
0903.0405	20x16x16	<b>3,90 €</b>	10	80
0903.0406	20x16x20	<b>4,00 €</b>	20	160
0903.0409	20x20x16	<b>4,40 €</b>	14	112
0903.0410	20x25x20	<b>6,60 €</b>	8	64
0903.0411	25x16x16	<b>7,20 €</b>	9	72
0903.0412	25x16x20	<b>6,20 €</b>	10	80
0903.0413	25x16x25	<b>7,10 €</b>	9	72
0903.0415	25x20x16	<b>7,10 €</b>	9	72
0903.0416	25x20x20	<b>7,10 €</b>	10	80
0903.0417	25x20x25	<b>8,20 €</b>	8	64
0903.0418	25x25x20	<b>8,80 €</b>	7	56
0903.0419	25x32x25	<b>11,00 €</b>	5	40
0903.0420	32x16x32	<b>11,00 €</b>	5	40
0903.0422	32x20x32	<b>11,00 €</b>	5	40
0903.0423	32x25x20	<b>11,00 €</b>	5	40
0903.0424	32x25x25	<b>11,00 €</b>	5	40
0903.0425	32x25x32	<b>11,00 €</b>	5	40
0903.0426	32x32x25	<b>11,00 €</b>	5	40
0903.0427	40x25x40	<b>25,00 €</b>	8	16
0903.0428	40x32x40	<b>25,00 €</b>	8	16
0903.0429	50x32x50	<b>38,00 €</b>	8	16
0903.0430	50x40x50	<b>40,00 €</b>	8	16
0903.0431	63x40x63	<b>50,00 €</b>	2	16
0903.0432	63x50x63	<b>70,00 €</b>	3	24



Joelho 90° Macho  
Male Elbow 90°

Codo 90° Macho  
Coude 90° Male

Ref.		€/Un.		
0903.1001	16x1/2	<b>2,60 €</b>	25	200
0903.1002	16x3/4	<b>3,40 €</b>	20	160
0903.1004	20x1/2	<b>3,40 €</b>	20	160
0903.1005	20x3/4	<b>3,80 €</b>	14	112
0903.1006	25x1/2	<b>5,20 €</b>	12	96
0903.1007	25x3/4	<b>6,00 €</b>	12	96
0903.1008	25x1	<b>8,00 €</b>	8	64
0903.1009	32x1	<b>8,80 €</b>	8	64



Joelho 90° Fêmea  
Female Elbow 90° Female

Codo 90° Fêmea  
Coude 90° Femelle

Ref.		€/Un.		
0903.0601	16x1/2	<b>2,80 €</b>	30	240
0903.0603	20x1/2	<b>3,30 €</b>	22	176
0903.0604	25x1/2	<b>4,80 €</b>	12	96
0903.0605	16x3/4	<b>3,10 €</b>	18	144
0903.0607	20x3/4	<b>3,50 €</b>	15	120
0903.0608	25x3/4	<b>5,60 €</b>	10	80
0903.0609	32x3/4	<b>7,90 €</b>	8	64
0903.0610	25x1	<b>7,40 €</b>	8	64
0903.0611	32x1	<b>9,00 €</b>	8	64
0903.0612	40x11/4	<b>20,00 €</b>	8	16
0903.0613	50x11/2	<b>27,60 €</b>	8	16
0903.0614	63x2	<b>57,00 €</b>	8	16

# Acessórios Multicamada Press

Accesórios de Multicapa Press | Multilayer Press Accessories | Accessoires Multicouche Press



Tê Simples  
Equal Tee

Te Igual  
Té Egal

Ref.		€/Un.		
0903.0301	16	<b>2,80 €</b>	20	160
0903.0303	20	<b>4,00 €</b>	14	112
0903.0304	25	<b>8,20 €</b>	6	48
0903.0305	32	<b>13,00 €</b>	4	32
0903.0306	40	<b>35,00 €</b>	8	16
0903.0307	50	<b>50,00 €</b>	8	16
0903.0308	63	<b>100,00 €</b>	8	16



Tê Fêmea  
Female Tee

Te Hembra  
Té Femelle

Ref.		€/Un.		
0903.0501	16x1/2	<b>3,60 €</b>	16	128
0903.0503	20x1/2	<b>4,70 €</b>	12	96
0903.0504	20x3/4	<b>5,30 €</b>	10	80
0903.0505	25x1/2	<b>7,80 €</b>	8	64
0903.0506	25x3/4	<b>9,00 €</b>	7	56
0903.0507	25x1	<b>10,00 €</b>	5	40
0903.0508	32x3/4	<b>10,50 €</b>	4	32
0903.0509	32x1	<b>12,00 €</b>	3	24
0903.0510	40x1 1/4	<b>31,00 €</b>	8	16
0903.0511	50x1 1/2	<b>39,00 €</b>	8	16
0903.0512	63x2	<b>87,00 €</b>	8	16



Cruzeta  
Cross

Cruz  
Croix

Ref.		€/Un.		
0903.1501	25x20x20x20	<b>9,80 €</b>	5	40
0903.1502	25x20x16x16	<b>9,10 €</b>	5	40
0903.1503	20x20x16x16	<b>5,90 €</b>	10	80
0903.1504	20x20x20x20	<b>6,80 €</b>	5	40
0903.1505	20x16x20x16	<b>7,00 €</b>	5	40



Distribuidor  
Manifold

Distribuidor  
Distributeur

Ref.		€/Un.		
0903.1402	20-20-16-16-16	<b>14,00 €</b>	5	40



Distribuidor  
Manifold

Distribuidor  
Distributeur

Ref.		€/Un.		
0903.1403	3/4 20-16-16	<b>15,00 €</b>	5	40



Válvula de Esfera  
Ball Valve

Válvula Esfera  
Vanne à Boisseau

Ref.		€/Un.		
0903.2401	16	<b>10,00 €</b>	5	40
0903.2402	20	<b>11,00 €</b>	5	40
0903.2403	25	<b>15,00 €</b>	5	40
0903.2404	32	<b>18,00 €</b>	4	32



Válvula Esfera "U"  
"U" Ball Valve

Válvula Esfera "U"  
Vanne à Boisseau "U"

Ref.		€/Un.		
0903.2611	16	<b>17,00 €</b>	5	40
0903.2612	20	<b>20,00 €</b>	5	40
0903.2613	25	<b>30,00 €</b>	5	40



Válvula Regulação  
Regulation Ball Valve

Válvula Regulación  
Vanne à Boisseau Reqlém

Ref.		€/Un.		
0903.2601	16	<b>14,00 €</b>	5	40
0903.2602	20	<b>15,00 €</b>	5	40
0903.2603	25	<b>22,00 €</b>	5	40



Válvula Linha  
Line Ball Valve

Válvula Lineal  
Vanne à Boisseau Lique

Ref.		€/Un.		
0903.2501	16	<b>8,00 €</b>	5	40
0903.2502	20	<b>9,00 €</b>	5	40
0903.2503	25	<b>16,00 €</b>	5	40
0903.2504	32	<b>18,00 €</b>	5	40

# Acessórios Multicamada Press

Accesórios de Multicapa Press | Multilayer Press Accessories | Accessoires Multicouche Press



Junta Electrolise  
Electrolytic Joint

Junta Electrólisis  
Union Electrolite



Junta Borracha  
Rubber Joint

Junta Goma  
Caoutchouc Joint



Casquilho Inox  
S. S. Sleeve

Casquilho Inox  
Douilles

Ref.		€/Un.	
0903.3001	16	<b>0,40 €</b>	100
0903.3003	20	<b>0,50 €</b>	100
0903.3004	25	<b>0,55 €</b>	100
0903.3005	32	<b>0,60 €</b>	100
0903.3006	40	<b>0,80 €</b>	100
0903.3007	50	<b>0,85 €</b>	100
0903.3008	63	<b>0,90 €</b>	100

Ref.		€/Un.	
0903.3101	16	<b>0,50 €</b>	100
0903.3103	20	<b>0,50 €</b>	100
0903.3104	25	<b>0,60 €</b>	100
0903.3105	32	<b>0,60 €</b>	100
0903.3106	40	<b>0,80 €</b>	100
0903.3107	50	<b>0,90 €</b>	100
0903.3108	63	<b>1,10 €</b>	100

Ref.		€/Un.		
0903.2901	16	<b>0,40 €</b>	100	800
0903.2903	20	<b>0,60 €</b>	100	800
0903.2904	25	<b>1,20 €</b>	50	400
0903.2905	32	<b>1,40 €</b>	30	240
0903.2906	40	<b>3,70 €</b>	10	80
0903.2907	50	<b>5,00 €</b>	10	80
0903.2908	63	<b>10,00 €</b>	10	80



Alargador  
Extension

Alargadera  
Allonge

Ref.		€/Un.	
0903.2701	20 m/m	<b>1,80 €</b>	25



Mola Exterior  
Outer Spring

Muelle Exterior  
Resort Extérieur

Ref.		€/Un.	
0903.3211	16	<b>8,00 €</b>	1
0903.3213	20	<b>9,00 €</b>	1
0903.3214	25	<b>10,00 €</b>	1
0903.3215	32	<b>15,00 €</b>	1



Mola Interior  
Inner Spring

Muelle Interior  
Resort Intérieur

Ref.		€/Un.	
0903.3201	16	<b>5,40 €</b>	1
0903.3202	20	<b>7,00 €</b>	1
0903.3203	25	<b>8,00 €</b>	1
0903.3204	32	<b>13,00 €</b>	1

## Modo de Instalação

Modo de Instalación | Installation Mode | Mode D'Installation



Mordentes  
Mordazas  
Press Jaws  
Mâchoires

RFZ/RFIZ/U



# Acessórios Multicamada Press

Accesórios de Multicapa Press | Multilayer Press Accessories | Accessoires Multicouchen Press



Manípulo(s)  
Handle(s)

Mando(s)  
Levier(s)



Calibrador  
Gauge

Calibrador  
Calibreur



Lubrificante  
Lubricant

Lubrificante  
Lubrifiant

Ref.		€/Un.		
0903.2801	*1 - retangular	6,00 €	5	150
0903.2802	*2 - comprido	6,00 €	5	150
0903.2803	*3 - redondo	5,00 €	5	150

Ref.		€/Un.		
0903.3221	16/18/20	14,00 €	15	120
0903.3222	20/25/32	14,00 €	10	80

Ref.		€/Un.	
0903.3243	400 ml	18,00 €	4

# Acessórios Multicamada Aperto

Accesórios de Compresión Multicapa | Multilayer Compression Accessories | Accessoires Multicouchen Compression



União Simples  
Raccord Égal  
Equal Union  
Unión Igual

Ref.		€/Un.		
0904.0001	16	3,50 €	30	240
0904.0003	20	5,80 €	18	144
0904.0004	25	10,00 €	11	88
0904.0005	32	13,40 €	7	56
0904.0006	40	25,00 €	3	24



União Redução  
Unión Reducción  
Reducing Union  
Raccord Réduit

Ref.		€/Un.		
0904.0101	20x16	4,60 €	20	160
0904.0103	25x20	7,80 €	12	96
0904.0104	32x25	12,00 €	6	48



União Macho  
Unión Macho  
Male Union  
Union Mâle

Ref.		€/Un.		
0904.0901	16x1/2	2,50 €	45	360
0904.0902	16x3/4	3,00 €	35	280
0904.0904	20x1/2	3,80 €	30	240
0904.0905	20x3/4	3,80 €	25	200
0904.0906	25x3/4	6,00 €	18	144
0904.0907	25x1	6,50 €	16	128
0904.0910	32x3/4	10,00 €	14	112
0904.0908	32x1	10,00 €	12	96
0904.0909	40x11/4	15,00 €	5	40



União Fêmea  
Unión Hembra  
Female Union  
Union Femelle

Ref.		€/Un.		
0904.1001	16x1/2	2,30 €	40	320
0904.1002	16x3/4	3,20 €	25	200
0904.1004	20x1/2	3,80 €	25	200
0904.1005	20x3/4	3,90 €	25	200
0904.1006	25x3/4	6,80 €	15	120
0904.1007	25x1	7,90 €	15	120
0904.1010	32x3/4	9,00 €	14	112
0904.1008	32x1	9,00 €	10	80
0904.1009	40x11/4	18,00 €	6	48





Joelho c/ Pater  
Codo Mural  
Wall Elbow  
Coude Mural

Ref.		€/Un.		
0904.0701	16x1/2	4,00 €	18	144
0904.0702	20x1/2	5,30 €	12	96



Joelho 90° Macho  
Codo 90° Macho  
Male Elbow 90°  
Coude 90° Male

Ref.		€/Un.		
0904.0601	16x1/2	3,18 €	25	200
0904.0602	20x1/2	4,00 €	18	144
0904.0603	25x3/4	7,50 €	15	120



Joelho 90° Fêmea  
Codo 90° Hembra  
Female Elbow 90°  
Coude 90° Femelle

Ref.		€/Un.		
0904.0501	16x1/2	3,20 €	25	200
0904.0502	16x3/4	3,80 €	25	200
0904.0504	20x1/2	4,20 €	18	144
0904.0505	20x3/4	4,80 €	18	144
0904.0506	25x3/4	7,40 €	15	120
0904.0507	25x1	8,00 €	12	96
0904.0508	32x1	10,00 €	10	80



Joelho 90°  
Codo 90°  
Elbow 90°  
Coude 90°

Ref.		€/Un.		
0904.0201	16	3,70 €	25	200
0904.0203	20	5,90 €	15	120
0904.0204	25	9,00 €	10	80
0904.0205	32	16,00 €	6	48
0904.0206	40	30,00 €	3	24



Tê Simples  
Te Igual  
Equal Tee  
Té Egal

Ref.		€/Un.		
0904.0301	16	5,35 €	16	128
0904.0303	20	8,30 €	11	88
0904.0304	25	15,80 €	7	56
0904.0305	32	19,00 €	5	40
0904.0306	40	40,00 €	2	16



Tê Redução  
Te Reduccion  
Reducing Tee  
Té Réduit

Ref.		€/Un.		
0904.0401	16x20x16	7,00 €	15	120
0904.0402	20x16x20	7,70 €	12	96
0904.0403	20x20x16	7,70 €	11	88
0904.0404	25x16x25	12,00 €	8	64
0904.0405	25x20x20	13,00 €	8	64
0904.0406	25x20x25	14,00 €	8	64
0904.0407	32x16x32	15,80 €	6	48
0904.0408	32x20x32	15,80 €	6	48
0904.0409	32x25x32	18,00 €	5	40



Válvula Esfera  
Válvula Esfera  
Ball Valve  
Vanne a Boisseau

Ref.		€/Un.		
0904.1101	16	16,00 €	5	40
0904.1102	20	17,00 €	5	40



Tê Fêmea  
Te Hembra  
Female Tee  
Té Femelle

Ref.		€/Un.		
0904.0801	16x1/2	5,00 €	18	144
0904.0802	20x1/2	7,10 €	12	96
0904.0805	20x3/4	12,30 €	9	72
0904.0803	25x3/4	11,00 €	9	72
0904.0804	32x1	18,00 €	5	40



Válvula Esfera Linha  
Válvula Esfera Linha  
Ball Valve Line  
Vanne à Boisseau Ligne

Ref.		€/Un.		
0904.1103	25	30,00 €	5	40

# 2.8



# wefatherm

MADE  
IN  
GERMANY



## Sistemas de Tubagem e Acessórios PP-R e PP-RCT

Sistemas de Tubos y Accesorios PP-R y PP-RCT | PP-R and PP-RCT Piping Systems and Accessories | Systèmes de Tube et Accessoires PP-R et PP-RCT

ISO 15874 | DIN 8077/8078



Sistemas PP-R Ø16-125 mm para Polifusão de encaixe.  
Sistemas PP-R Ø16-125 mm para Polifusion de encaje.  
PP-R Ø16-125 mm systems for Socket Welding.  
Systèmes PP-R Ø16-125 mm pour Polyfusion.



Sistemas PP-RCT Ø160-315 mm para Soldadura topo a topo.  
Sistemas PP-RCT Ø160-315 mm para Soldadura tope a tope.  
PP-RCT Ø160-315 mm systems for Butt Welding.  
Systèmes PP-RCT Ø160-315 mm Soudage bout à bout.

### Aplicações | Aplicaciones | Applications | Applications



Distribuição de água quente  
Distribución de agua caliente  
Hot water distribution  
Distribution d'eau chaude



Aplicações sanitárias  
Aplicaciones sanitarias  
Sanitary applications  
Applications sanitaires



Água potável  
Agua potable  
Drinking water  
Eau potable



WRAS



# Tube e Acessórios PP-R

Tube y Accesorios PP-R | PP-R Pipe and Accessoires | Tube et Accessoires PP-R



Tubo PPR SDR6 (PN20)  
PP-R Pipe SDR6 (PN20)

Tubo PP-R SDR6 (PN20)  
Tube PP-R SDR6 (PN20)

Ref.		€/m		
WF0391.0402	20x3,4 L4m	1,21 €	100 m	-
WF0391.0403	25x4,2 L4m	1,91 €	100 m	-
WF0391.0404	32x5,4 L4m	3,08 €	40 m	-
WF0391.0405	40x6,7 L4m	5,33 €	40 m	-
WF0391.0406	50x8,3 L4m	8,40 €	20 m	-
WF0391.0407	63x10,5 L4m	13,57 €	20 m	-
WF0391.0408	75x12,5 L4m	20,57 €	12 m	-
WF0391.0409	90x15 L4m	29,57 €	12 m	-
WF0391.0410	110x18,3 L4m	39,56 €	8 m	-
WF0391.0411	125x20,8 L4m	49,57 €	4 m	-



Joelho 90°  
Elbow 90°

Codo 90°  
Coude 90°

Ref.		€/Un.		
WF0392.0802	20	0,31 €	10	300
WF0392.0803	25	0,42 €	10	200
WF0392.0804	32	0,89 €	10	120
WF0392.0805	40	1,51 €	5	60
WF0392.0806	50	2,86 €	5	30
WF0392.0807	63	5,11 €	1	15
WF0392.0808	75	7,66 €	1	12
WF0392.0809	90	14,66 €	1	6
WF0392.0810	110	20,06 €	1	4
WF0392.0811	125	37,49 €	1	2



Joelho 90° M/F  
Elbow 90° M/F

Codo 90° M/H  
Coude 90° M/F

Ref.		€/Un.		
WF0392.0902	20	0,31 €	10	250
WF0392.0903	25	0,43 €	10	150
WF0392.0904	32	0,91 €	10	100



Tubo PPR Fibra SDR7'4 (PN16)  
PP-R Pipe Fiber SDR7'4 (PN16)

Tubo PP-R Fibra SDR7'4 (PN16)  
Tube PP-R Fibre SDR7'4 (PN16)

Ref.		€/m		
WF0391.0702	20x2,8 L4m	1,89 €	100 m	-
WF0391.0703	25x3,5 L4m	2,71 €	100 m	-
WF0391.0704	32x4,4 L4m	4,06 €	40 m	-
WF0391.0705	40x5,5 L4m	5,83 €	40 m	-
WF0391.0706	50x6,9 L4m	9,03 €	20 m	-
WF0391.0707	63x8,6 L4m	14,29 €	20 m	-
WF0391.0708	75x10,3 L4m	18,80 €	12 m	-
WF0391.0709	90x12,3 L4m	27,11 €	12 m	-
WF0391.0710	110x15,1 L4m	40,20 €	8 m	-
WF0391.0711	125x17,1 L4m	51,86 €	4 m	-



Joelho 45°  
Elbow 45°

Codo 45°  
Coude 45°

Ref.		€/Un.		
WF0392.1002	20	0,44 €	10	300
WF0392.1003	25	0,60 €	10	200
WF0392.1004	32	0,83 €	10	100
WF0392.1005	40	2,31 €	5	60
WF0392.1006	50	2,37 €	5	40
WF0392.1007	63	5,29 €	1	20
WF0392.1008	75	7,23 €	1	15
WF0392.1009	90	11,43 €	1	8
WF0392.1010	110	28,86 €	1	4
WF0392.1011	125	38,43 €	1	2



Joelho 45° M/F  
Elbow 45° M/F

Codo 45° M/H  
Coude 45° M/F

Ref.		€/Un.		
WF0392.1102	20	0,46 €	10	250
WF0392.1103	25	0,54 €	10	200
WF0392.1104	32	1,03 €	10	100

# Tubo e Acessórios PP-R

Tubo y Accesorios PP-R | PP-R Pipe and Accessoires | Tube et Accessoires PP-R



União  
Coupling

Manguito  
Manchon

Ref.		€/Un.		
WF0392.0302	20	0,25 €	10	350
WF0392.0303	25	0,31 €	10	300
WF0392.0304	32	0,42 €	10	150
WF0392.0305	40	0,94 €	5	100
WF0392.0306	50	1,74 €	5	60
WF0392.0307	63	3,14 €	1	30
WF0392.0308	75	5,43 €	1	20
WF0392.0309	90	6,06 €	1	15
WF0392.0310	10	9,86 €	1	10
WF0392.0311	125	20,69 €	1	6



União Cruzamento  
Bridge

Salvatubos  
Courbe de Franchissement

Ref.		€/Un.		
WF0392.0102	20	1,20 €	10	100
WF0392.0103	25	1,37 €	10	60
WF0392.0104	32	2,00 €	5	30



Tampão  
Cap

Tapón  
Bouchon

Ref.		€/Un.		
WF0392.1302	20	0,28 €	10	400
WF0392.1303	25	0,40 €	10	300
WF0392.1304	32	0,54 €	10	200
WF0392.1305	40	2,26 €	5	100
WF0392.1306	50	2,71 €	5	50
WF0392.1307	63	3,40 €	1	40
WF0392.1308	75	6,77 €	1	25
WF0392.1309	90	12,37 €	1	15
WF0392.1310	110	17,80 €	1	10
WF0392.1311	125	22,51 €	1	6



Tê 90°  
Tee 90°

Te 90°  
Tê 90°

Ref.		€/Un.		
WF0392.0502	20	0,33 €	10	200
WF0392.0503	25	0,47 €	10	120
WF0392.0504	32	0,97 €	10	80
WF0392.0505	40	1,97 €	5	40
WF0392.0506	50	3,69 €	5	20
WF0392.0507	63	5,91 €	1	15
WF0392.0508	75	9,51 €	1	10
WF0392.0509	90	16,94 €	1	6
WF0392.0510	110	23,03 €	1	4
WF0392.0511	125	40,34 €	1	3



União Cruzamento F/F  
Bridge F/F

Salvatubos H/H  
Courbe de Franchissement F/F

Ref.		€/Un.		
WF0392.0202	20	0,80 €	10	120
WF0392.0203	25	1,26 €	10	60



Curva 90°  
Bend 90°

Curva 90°  
Courbe 90°

Ref.		€/Un.		
WF0392.0702	20	1,89 €	10	150
WF0392.0703	25	1,97 €	10	80
WF0392.0704	32	2,23 €	5	50
WF0392.0705	40	4,37 €	5	25



# Tubo e Acessórios PP-R

Tubo y Accesorios PP-R | PP-R Pipe and Accessoires | Tube et Accessoires PP-R



Tê Redução 90°  
Reduced Tee 90°

Te Reducción 90°  
Té Reduit 90°

Ref.		€/Un.		
WF0392.0603	25x 20x 25	<b>0,60 €</b>	10	150
WF0392.0604	32x 20x 32	<b>0,91 €</b>	10	80
WF0392.0605	32x 25x 32	<b>0,97 €</b>	10	80
WF0392.0606	32x 32x 25	<b>1,20 €</b>	10	80
WF0392.0607	25x 20x 20	<b>0,77 €</b>	10	120
WF0392.0608	20x 25x 25	<b>0,77 €</b>	10	120
WF0392.0609	32x 20x 25	<b>1,20 €</b>	10	80
WF0392.0610	32x 25x 25	<b>1,20 €</b>	10	80
WF0392.0611	40x 20x 40	<b>1,94 €</b>	5	40
WF0392.0612	40x 25x 40	<b>1,97 €</b>	5	40
WF0392.0613	40x 32x 40	<b>2,11 €</b>	5	40
WF0392.0614	50x 20x 50	<b>4,26 €</b>	5	20
WF0392.0615	50x 25x 50	<b>4,46 €</b>	5	20
WF0392.0616	50x 32x 50	<b>3,60 €</b>	5	20
WF0392.0617	50x 40x 50	<b>3,86 €</b>	5	20
WF0392.0618	63x 20x 63	<b>5,74 €</b>	1	15
WF0392.0619	63x 25x 63	<b>7,23 €</b>	1	15
WF0392.0620	63x 32x 63	<b>5,83 €</b>	1	15
WF0392.0621	63x 40x 63	<b>6,86 €</b>	1	15
WF0392.0622	63x 50x 63	<b>6,86 €</b>	1	15
WF0392.0623	75x 20x 75	<b>9,14 €</b>	1	10
WF0392.0624	75x 25x 75	<b>9,14 €</b>	1	10
WF0392.0625	75x 32x 75	<b>9,14 €</b>	1	10
WF0392.0626	75x 40x 75	<b>11,05 €</b>	1	10
WF0392.0627	75x 50x 75	<b>11,57 €</b>	1	10
WF0392.0628	75x 63x 75	<b>11,57 €</b>	1	10
WF0392.0629	90x 63x 90	<b>20,83 €</b>	1	6
WF0392.0630	90x 75x 90	<b>20,83 €</b>	1	6
WF0392.0631	110x 63x110	<b>35,03 €</b>	1	4
WF0392.0632	110x 75x110	<b>35,03 €</b>	1	4
WF0392.0633	110x 90x110	<b>35,03 €</b>	1	4
WF0392.0634	125x 75x125	<b>44,09 €</b>	1	2
WF0392.0635	125x 90x125	<b>45,60 €</b>	1	2
WF0392.0636	125x110x125	<b>45,28 €</b>	1	2



União Redução  
Reducer

Unión Reducción  
Reduction

Ref.		€/Un.		
WF0392.0403	25x20	<b>0,31 €</b>	10	300
WF0392.0404	32x20	<b>0,42 €</b>	5	200
WF0392.0405	32x25	<b>0,42 €</b>	10	200
WF0392.0406	40x20	<b>0,66 €</b>	5	100
WF0392.0407	40x25	<b>0,66 €</b>	10	100
WF0392.0408	40x32	<b>0,89 €</b>	5	100
WF0392.0409	50x20	<b>1,20 €</b>	5	100
WF0392.0410	50x25	<b>1,03 €</b>	5	100
WF0392.0411	50x32	<b>1,03 €</b>	5	100
WF0392.0412	50x40	<b>1,09 €</b>	5	80
WF0392.0413	63x40	<b>2,26 €</b>	5	50
WF0392.0414	63x25	<b>1,66 €</b>	1	50
WF0392.0415	63x32	<b>1,29 €</b>	1	50
WF0392.0416	63x50	<b>2,37 €</b>	1	40
WF0392.0417	75x50	<b>5,54 €</b>	1	30
WF0392.0418	75x63	<b>4,43 €</b>	1	20
WF0392.0419	90x63	<b>4,60 €</b>	1	16
WF0392.0420	90x75	<b>5,03 €</b>	1	16
WF0392.0421	110x90	<b>9,54 €</b>	1	10
WF0392.0422	125x110	<b>25,86 €</b>	1	6

# Tube e Acessórios PP-R

Tube y Accesorios PP-R | PP-R Pipe and Accessoires | Tube et Accessoires PP-R



Casquilho R/F  
Female Threaded Joint

Unión R/H  
Raccord Femelle

Ref.		€/Un.		
WF0392.1602	20x1/2"	<b>2,66 €</b>	10	100
WF0392.1603	20x3/4"	<b>3,91 €</b>	10	80
WF0392.1604	25x1/2"	<b>2,77 €</b>	10	100
WF0392.1605	25x3/4"	<b>2,83 €</b>	10	80



Casquilho R/F  
Female Threaded Joint

Unión R/H  
Raccord Femelle

Ref.		€/Un.		
WF0392.1606	32x1"	<b>9,14 €</b>	5	30
WF0392.1607	40x1 1/4"	<b>13,06 €</b>	5	25
WF0392.1608	50x1 1/2"	<b>19,37 €</b>	1	15
WF0392.1609	63x2"	<b>32,06 €</b>	1	10
WF0392.1610	75x2"	<b>61,51 €</b>	1	8



União Eletrosoldável  
Electrofusion Coupler

Unión Electrosoldable  
Manchon Electrique

Ref.		€/Un.		
WF0392.1502	20	<b>14,89 €</b>	1	30
WF0392.1503	25	<b>16,00 €</b>	1	30
WF0392.1504	32	<b>16,69 €</b>	1	30
WF0392.1505	40	<b>18,34 €</b>	1	30
WF0392.1506	50	<b>19,63 €</b>	1	20
WF0392.1507	63	<b>29,23 €</b>	1	10
WF0392.1508	75	<b>35,77 €</b>	1	10
WF0392.1509	90	<b>45,23 €</b>	1	5
WF0392.1510	110	<b>62,89 €</b>	1	5
WF0392.1511	125	<b>109,43 €</b>	1	2



Casquilho R/M  
Male Threaded Joint

Unión R/M  
Raccord Mâle

Ref.		€/Un.		
WF0392.1702	20x1/2"	<b>3,06 €</b>	10	80
WF0392.1703	20x3/4"	<b>5,06 €</b>	10	60
WF0392.1704	25x1/2"	<b>3,11 €</b>	10	80
WF0392.1705	25x3/4"	<b>5,06 €</b>	10	60



Casquilho R/M  
Male Threaded Joint

Unión R/M  
Raccord Mâle

Ref.		€/Un.		
WF0392.1706	32x1"	<b>10,66 €</b>	5	40
WF0392.1707	40x1 1/4"	<b>15,94 €</b>	5	25
WF0392.1708	50x1 1/2"	<b>20,20 €</b>	1	15
WF0392.1709	63x2"	<b>37,46 €</b>	1	10
WF0392.1710	75x2 1/2"	<b>65,80 €</b>	1	6
WF0392.1711	90x3"	<b>73,57 €</b>	1	3
WF0392.1712	110x3"	<b>78,77 €</b>	1	2
WF0392.1713	110x4"	<b>140,20 €</b>	1	2



Cruzeta  
Cross

Cruz  
Croix

Ref.		€/Un.		
WF0392.1204	32	<b>2,77 €</b>	5	50
WF0392.1205	40	<b>4,66 €</b>	5	30
WF0392.1206	50	<b>7,40 €</b>	1	15
WF0392.1207	63	<b>10,46 €</b>	1	10

# Tube e Acessórios PP-R

Tube y Accesorios PP-R | PP-R Pipe and Accessoires | Tube et Accessoires PP-R



Joelho 90° R/F  
Female Threaded Elbow

Codo 90° R/H  
Coude 90° Femelle

Ref.		€/Un.		
WF0392.1802	20x1/2"	<b>2,71 €</b>	10	50
WF0392.1803	20x3/4"	<b>4,06 €</b>	10	50
WF0392.1804	25x1/2"	<b>3,20 €</b>	10	70
WF0392.1805	25x3/4"	<b>5,14 €</b>	10	60
WF0392.1806	32x3/4"	<b>5,51 €</b>	10	40
WF0392.1807	32x1"	<b>9,23 €</b>	5	25



Joelho 90° M/F c/ Porca  
Connection Elbow M/F w/ Nut

Codo 90° M/H c/ Tuerca  
Coude 90° M/F a/ Écrou

Ref.		€/Un.		
WF0392.2101	20x1/2"	<b>15,89 €</b>	10	50
WF0392.2102	25x1/2"	<b>16,49 €</b>	10	50



União 2P R/F  
Pipe Union Brass Female

Enlace Desmontable R/H  
Raccord Détachable Femelle

Ref.		€/Un.		
WF0392.2202	20x1/2"	<b>16,80 €</b>	10	60
WF0392.2203	20x3/4"	<b>19,60 €</b>	10	40
WF0392.2204	25x1/2"	<b>16,80 €</b>	5	50
WF0392.2205	25x3/4"	<b>19,60 €</b>	5	40
WF0392.2206	32x1"	<b>26,69 €</b>	5	25
WF0392.2207	32x3/4"	<b>19,60 €</b>	5	35
WF0392.2208	40x1 1/4"	<b>32,60 €</b>	1	15
WF0392.2209	50x1 1/2"	<b>43,80 €</b>	1	10
WF0392.2210	63x2"	<b>60,60 €</b>	1	6
WF0392.2211	75x2 1/2"	<b>138,46 €</b>	1	3



Joelho 90° R/M  
Male Threaded Elbow

Codo 90° R/M  
Coude 90° Mâle

Ref.		€/Un.		
WF0392.1902	20x1/2"	<b>3,11 €</b>	10	60
WF0392.1903	20x3/4"	<b>5,17 €</b>	10	50
WF0392.1904	25x1/2"	<b>3,40 €</b>	10	60
WF0392.1905	25x3/4"	<b>5,20 €</b>	10	50
WF0392.1906	32x3/4"	<b>6,43 €</b>	10	40
WF0392.1907	32x1"	<b>10,86 €</b>	5	30



Joelho 90° M/F c/ Porca  
Connection Elbow M/F w/ Nut

Codo 90° M/H c/ Tuerca  
Coude 90° M/F a/ Écrou

Ref.		€/Un.		
WF0392.2103	20x1/2"	<b>18,14 €</b>	10	40



União 2P R/M  
Pipe Union Brass Male

Enlace Desmontable R/M  
Raccor Détachable Mâle

Ref.		€/Un.		
WF0392.2302	20x1/2"	<b>9,74 €</b>	10	80
WF0392.2303	20x3/4"	<b>14,51 €</b>	10	50
WF0392.2304	25x1/2"	<b>9,74 €</b>	5	50
WF0392.2305	25x3/4"	<b>15,03 €</b>	5	50
WF0392.2306	32x1"	<b>21,80 €</b>	5	30
WF0392.2307	32x3/4"	<b>13,43 €</b>	5	40
WF0392.2308	40x1 1/4"	<b>38,63 €</b>	1	12
WF0392.2309	50x1 1/2"	<b>39,94 €</b>	1	15
WF0392.2310	63x2"	<b>60,80 €</b>	1	6
WF0392.2311	75x2 1/2"	<b>134,29 €</b>	1	3

# Tube e Acessórios PP-R

Tube y Accesorios PP-R | PP-R Pipe and Accessoires | Tube et Accessoires PP-R



Falange c/ Junta  
Flange Sleeve

Portabrida  
Raccord-Bride

Ref.		€/Un.		
WF0392.1404	32	<b>3,37 €</b>	1	100
WF0392.1405	40	<b>4,63 €</b>	1	100
WF0392.1406	50	<b>6,14 €</b>	1	50
WF0392.1407	63	<b>8,34 €</b>	1	40
WF0392.1408	75	<b>12,86 €</b>	1	30
WF0392.1409	90	<b>16,09 €</b>	1	15
WF0392.1410	110	<b>19,91 €</b>	1	10
WF0392.1411	125	<b>33,09 €</b>	1	5



Colector  
Manifold

Colector  
Collecteur

Ref.		€/Un.		
WF0392.2701	4x 25/16	<b>6,43 €</b>	5	25
WF0392.2702	4x 32/20	<b>6,43 €</b>	1	20



Colector R/F  
Manifold Female

Colector R/H  
Collecteur Femelle

Ref.		€/Un.		
WF0392.2704	32/1/2"	<b>23,20 €</b>	1	15
WF0392.2705	40/1/2"	<b>23,20 €</b>	1	10



Colector R/M  
Manifold Male

Colector R/M  
Collecteur Mâle

Ref.		€/Un.		
WF0392.2706	32/1/2"	<b>29,37 €</b>	1	15
WF0392.2707	40/1/2"	<b>30,77 €</b>	1	10



Tê R/F  
Female Threaded Tee

Te R/H  
Té Femelle

Ref.		€/Un.		
WF0392.2002	20x1/2"	<b>2,71 €</b>	10	60
WF0392.2003	20x3/4"	<b>4,91 €</b>	10	40
WF0392.2004	25x1/2"	<b>2,94 €</b>	10	50
WF0392.2005	25x3/4"	<b>4,17 €</b>	10	50
WF0392.2006	32x3/4"	<b>5,80 €</b>	10	40
WF0392.2007	32x1"	<b>9,31 €</b>	5	20



Joelho 90° c/ Pater  
Flexible Hose Conic Nut

Codo Placa90°  
Coude 90° Mural

Ref.		€/Un.		
WF0392.2802	20x1/2"	<b>2,71 €</b>	10	50
WF0392.2803	20x3/4"	<b>5,29 €</b>	10	50
WF0392.2804	25x1/2"	<b>2,89 €</b>	10	50
WF0392.2805	25x3/4"	<b>4,03 €</b>	10	50



Casquilho c/ Porca Louca  
Connection Loose Nut

Enlace Tuerca Loca  
Raccord Écrou Tournant

Ref.		€/Un.		
WF0392.2402	20x3/4"	<b>13,03 €</b>	10	70
WF0392.2403	20x1"	<b>16,06 €</b>	10	40
WF0392.2404	25x3/4"	<b>13,03 €</b>	10	70
WF0392.2405	25x1"	<b>16,06 €</b>	10	50
WF0392.2406	32x1"	<b>16,06 €</b>	5	50
WF0392.2407	32x1 1/4"	<b>17,31 €</b>	5	40
WF0392.2408	40x1 1/2"	<b>27,66 €</b>	1	20
WF0392.2409	50x1 1/2"	<b>44,97 €</b>	1	15
WF0392.2410	63x2"	<b>52,23 €</b>	1	8
WF0392.2411	75x2 1/2"	<b>74,00 €</b>	1	4



# Tubo e Acessórios PP-R

Tubo y Accesorios PP-R | PP-R Pipe and Accessoires | Tube et Accessoires PP-R



Enxerto  
Weld In Saddle

Injerto  
Raccord Selle

Ref.		€/Un.		
WF0392.2901	40/20	1,06 €	10	120
WF0392.2902	40/25	1,06 €	10	120
WF0392.2903	50/20	1,06 €	10	120
WF0392.2904	50/25	1,06 €	10	120
WF0392.2905	63/20	1,06 €	10	120
WF0392.2906	63/25	1,06 €	10	120
WF0392.2907	75/20	1,06 €	10	120
WF0392.2908	75/25	1,06 €	10	120
WF0392.2909	90/20	1,09 €	10	120
WF0392.2910	90/25	1,09 €	10	120
WF0392.2911	110/20	1,09 €	10	120
WF0392.2912	110/25	1,09 €	10	120
WF0392.2913	125/20	1,09 €	10	100
WF0392.2914	125/25	1,09 €	10	100
WF0392.2915	125/63	8,59 €	5	20



Enxerto R/M  
Weld In Saddle Male

Injerto R/M  
Raccord Selle Mâle

Ref.		€/Un.		
WF0392.3405	40x1/2"	4,77 €	10	100
WF0392.3406	50x1/2"	4,77 €	10	100
WF0392.3407	63x1/2"	4,77 €	10	100
WF0392.3408	75x1/2"	4,77 €	10	100
WF0392.3409	90x1/2"	4,77 €	10	100
WF0392.3410	110x1/2"	4,77 €	10	100
WF0392.3411	125x1/2"	4,77 €	10	100
WF0392.3412	40x3/4"	6,94 €	10	50
WF0392.3413	50x3/4"	6,94 €	10	50
WF0392.3414	63x3/4"	6,94 €	10	60
WF0392.3415	75x3/4"	6,94 €	10	60
WF0392.3416	90x3/4"	6,94 €	10	60
WF0392.3417	110x3/4"	6,94 €	10	60
WF0392.3418	125x3/4"	6,94 €	10	60



Enxerto R/F  
Weld In Saddle Female

Injerto R/H  
Raccord Selle Femelle

Ref.		€/Un.		
WF0392.3105	40x1/2"	4,03 €	10	100
WF0392.3106	50x1/2"	4,03 €	10	100
WF0392.3107	63x1/2"	4,03 €	10	100
WF0392.3108	75x1/2"	4,03 €	10	100
WF0392.3109	90x1/2"	4,03 €	10	100
WF0392.3110	110x1/2"	4,03 €	10	100
WF0392.3111	125x1/2"	4,03 €	10	100
WF0392.3205	40x3/4"	4,43 €	10	80
WF0392.3206	50x3/4"	4,43 €	10	80
WF0392.3207	63x3/4"	4,43 €	10	80
WF0392.3208	75x3/4"	4,43 €	10	80
WF0392.3209	90x3/4"	4,43 €	10	50
WF0392.3210	110x3/4"	4,43 €	10	50
WF0392.3211	125x3/4"	4,43 €	10	50



Caixa Passador Y  
Valve Body Y

Cuerpo Válvula Y  
Corp Vanne Y

Ref.		€/Un.		
WF0392.4303	25x3/4"	13,17 €	1	30
WF0392.4304	32x1"	24,51 €	1	25
WF0392.4305	40x1 1/4"	25,20 €	1	13



Caixa Passador  
Valve Body

Cuerpo Válvula  
Corp Vanne

Ref.		€/Un.		
WF0392.4002	20x3/4"	5,03 €	1	25
WF0392.4003	25x3/4"	5,31 €	1	25
WF0392.4004	32x1"	8,80 €	1	20

# Tubo e Acessórios PP-R

Tubo y Accesorios PP-R | PP-R Pipe and Accessoires | Tube et Accessoires PP-R



Passador Corte  
Concealed Valve

Llave de Paso  
Robinet a/ Poignee

Ref.		€/Un.		
WF0392.3702	20	<b>18,26 €</b>	1	15
WF0392.3703	25	<b>21,03 €</b>	1	15
WF0392.3704	32	<b>24,63 €</b>	1	10



Passador Corte AQ  
Concealed Valve HW

Llave de Paso AC  
Robinet a/ Poignee EC

Ref.		€/Un.		
WF0392.3802	20	<b>20,71 €</b>	1	15
WF0392.3803	25	<b>21,53 €</b>	1	15
WF0392.3804	32	<b>31,83 €</b>	1	10



Passador Corte Reg. Oculta  
Concealed Valve

Llave de Paso Reg. Oculta  
Robinet à Encastrer

Ref.		€/Un.		
WF0392.3902	20	<b>14,11 €</b>	1	15
WF0392.3903	25	<b>17,51 €</b>	1	15
WF0392.3904	32	<b>18,23 €</b>	1	15



Passador Corte c/Volante  
Stop Valve Surface

Llave de Paso c/Volante  
Robinet a/Volant

Ref.		€/Un.		
WF0392.3602	20	<b>13,20 €</b>	1	25
WF0392.3603	25	<b>16,77 €</b>	1	25
WF0392.3604	32	<b>17,34 €</b>	1	15



Passador Y  
Y - Valve

Válvula Asiento Y  
Robinet Y

Ref.		€/Un.		
WF0392.4103	25	<b>31,14 €</b>	1	20
WF0392.4104	32	<b>52,14 €</b>	1	12
WF0392.4105	40	<b>52,89 €</b>	1	7



Passador Y KFR  
Y - Valve KFR

Válvula Asiento Y KFR  
Robinet Y KFR

Ref.		€/Un.		
WF0392.4203	25	<b>33,49 €</b>	1	20
WF0392.4204	32	<b>56,20 €</b>	1	10
WF0392.4205	40	<b>56,20 €</b>	1	8

# Tubo e Acessórios PP-R

Tubo y Accesorios PP-R | PP-R Pipe and Accessoires | Tube et Accessoires PP-R



Purgador  
Drain Socket

Válvula de Purga  
Purge

Ref.		€/Un.		
WF0392.4402	20	<b>12,34 €</b>	1	40
WF0392.4403	25	<b>12,60 €</b>	1	40
WF0392.4404	32	<b>13,90 €</b>	1	30
WF0392.4405	40	<b>14,45 €</b>	1	20



Passador Esfera  
Ball Valve

Válvula Esfera  
Vanne Sphere

Ref.		€/Un.		
WF0392.4502	20	<b>8,40 €</b>	1	50
WF0392.4503	25	<b>13,43 €</b>	1	25
WF0392.4504	32	<b>20,89 €</b>	1	15
WF0392.4505	40	<b>33,31 €</b>	1	10
WF0392.4506	50	<b>36,49 €</b>	1	6
WF0392.4507	63	<b>59,29 €</b>	1	5
WF0392.4508	75	<b>69,66 €</b>	1	4



Extensão  
Extension

Alargadera  
Extension

Ref.		€/Un.		
WF0392.4601	95mm	<b>12,06 €</b>	1	20

\* Válvulas encastrar  
\* Válvulas empotrar  
\* Concealed valves  
\* Vannes à encastrer



Extensão  
Extension

Alargadera  
Extension

Ref.		€/Un.		
WF0392.4603	30mm	<b>6,06 €</b>	1	20

\* Válvulas de superfície  
\* Válvulas de superfície  
\* Surface valves  
\* Vannes de surface



Tubo PP-RCT SDR11  
PP-RCT Pipe SDR11

Tubo PP-RCT SDR11  
Tube PP-RCT SDR11

Ref.		€/Un.
WF0393.0012	160	<b>86,51 €</b>
WF0393.0013	200	<b>160,31 €</b>
WF0393.0014	250	<b>249,94 €</b>
WF0393.0015	315	<b>402,06 €</b>



T. PP-RCT Fibra SDR11  
PP-RCT P. Fiber SDR11

T. PP-RCT Fibra SDR11  
T. PP-RCT Fibre SDR11

Ref.		€/Un.
WF0393.0112	160	<b>102,03 €</b>
WF0393.0113	200	<b>198,11 €</b>
WF0393.0114	250	<b>309,23 €</b>



Joelho 90° comprido  
Elbow 90° Long

Codo 90° Largo  
Coude 90° Longue

Ref.		€/Un.
WF0393.0212	160	<b>75,89 €</b>
WF0393.0213	200	<b>336,66 €</b>
WF0393.0214	250	<b>484,20 €</b>
WF0393.0215	315	<b>923,09 €</b>



Joelho 90° Curto  
Elbow 90° Short

Codo 90° Corto  
Coude 90° Court

Ref.		€/Un.
WF0393.0312	160	<b>41,34 €</b>
WF0393.0313	200	<b>82,34 €</b>
WF0393.0314	250	<b>174,71 €</b>
WF0393.0315	315	<b>301,49 €</b>



Joelho 45°  
Elbow 45°

Codo 45°  
Coude 45°

Ref.		€/Un.
WF0393.0412	160	<b>69,31 €</b>
WF0393.0413	200	<b>297,17 €</b>
WF0393.0414	250	<b>411,66 €</b>
WF0393.0415	315	<b>889,26 €</b>



Tê 90° comprido  
Tee 90° Long

Te 90° Largo  
Té 90° Longue

Ref.		€/Un.
WF0393.0512	160	<b>128,69 €</b>
WF0393.0513	200	<b>244,23 €</b>
WF0393.0514	250	<b>757,03 €</b>
WF0393.0515	315	<b>1.188,86 €</b>



# Tube e Acessórios PP-RCT

Tube y Accesorios PP-RCT | PP-RCT Pipe and Accessories | Tube et Accessoires PP-RCT



Tê 90° Curto  
Tee 90° Short

Te 90° Corta  
Té 90° Court

Ref.		€/Un.
WF0393.0612	160	<b>56,63 €</b>
WF0393.0613	200	<b>135,29 €</b>
WF0393.0614	250	<b>269,63 €</b>
WF0393.0615	315	<b>546,91 €</b>



Tampão  
Cap

Tapón  
Bouchon

Ref.		€/Un.
WF0393.0712	160	<b>98,57 €</b>
WF0393.0713	200	<b>108,34 €</b>
WF0393.0714	250	<b>145,40 €</b>
WF0393.0715	315	<b>280,66 €</b>



União Redução Comprida  
Reducer Long

Reducción Larga  
Reduction Longue

Ref.		€/Un.
WF0393.0812	160-110	<b>62,46 €</b>
WF0393.0813	160-125	<b>67,24 €</b>
WF0393.0814	200-160	<b>101,63 €</b>
WF0393.0815	250-160	<b>128,83 €</b>
WF0393.0816	250-200	<b>158,09 €</b>
WF0393.0817	315-250	<b>276,23 €</b>



União Redução Curta  
Reducer Short

Reducción Corta  
Reduction Court

Ref.		€/Un.
WF0393.0912	200-160	<b>34,29 €</b>
WF0393.0913	250-160	<b>47,29 €</b>
WF0393.0914	250-200	<b>59,09 €</b>
WF0393.0915	315-250	<b>196,51 €</b>



Terminal Comprido  
Stub End Long

Terminal largo  
Bride Longue

Ref.		€/Un.
WF0393.1012	160	<b>115,69 €</b>
WF0393.1013	200	<b>204,14 €</b>
WF0393.1014	250	<b>294,74 €</b>
WF0393.1015	315	<b>407,51 €</b>



Terminal Curto  
Stub End Short

Terminal Corto  
Bride Court

Ref.		€/Un.
WF0393.1112	160	<b>29,97 €</b>
WF0393.1113	200	<b>58,46 €</b>
WF0393.1114	250	<b>88,14 €</b>
WF0393.1115	315	<b>117,23 €</b>



União Electrosoldável  
Electric Coupling

Manguito Eléctrico  
Raccord Électrique

Ref.		€/Un.
WF0393.1212	160	<b>86,00 €</b>
WF0393.1213	200	<b>202,46 €</b>
WF0393.1214	250	<b>309,74 €</b>
WF0393.1215	315	<b>420,86 €</b>



Abraçadeira  
Pipe Clamp

Abrazadera  
Collier de Servage



Placa c/ Abraçadeiras  
Plate w/ Pipe Clamps



Placa c/ Abrazaderas  
Plaque a/ Collier de Serrage





Abraçadeira Clip  
Pipe Clip

Abrazadera Clip  
Collier de Serrage Clip

Ref.		€/Un.	
WF0392.4702	20	1,14 €	50
WF0392.4703	25	1,23 €	50
WF0392.4704	32	1,29 €	50
WF0392.4705	40	1,34 €	40
WF0392.4706	50	1,66 €	25
WF0392.4707	63	2,03 €	25
WF0392.4708	75	6,49 €	25
WF0392.4709	90	8,14 €	13
WF0392.4710	110	9,71 €	13
WF0392.4711	125	9,80 €	13

Ref.		€/Un.	
WF0392.4802	20	12,69 €	20
WF0392.4803	25	12,77 €	20
WF0392.4804	32	12,89 €	15
WF0392.4805	40	14,37 €	15
WF0392.4806	50	14,97 €	10
WF0392.4807	63	17,43 €	10
WF0392.4808	75	17,80 €	10

Ref.		€/Un.	
WF0392.4902	20	0,46 €	50
WF0392.4903	25	0,63 €	50
WF0392.4904	32	0,69 €	50





Junta EPDM  
Gasket EPDM



Junta EPDM  
Joint EPDM



Falange PP  
Flange PP

Brida PP  
Bride PP



Ref.		€/Un.	
WF0393.1712	160/150	21,57 €	1
WF0393.1713	200/200	27,69 €	1
WF0393.1714	250/250	36,49 €	1
WF0393.1715	315/300	46,31 €	1

Ref.		€/Un.	
WF0393.1612	160/150	96,51 €	1
WF0393.1613	200/200	134,63 €	1
WF0393.1614	250/250	211,69 €	1
WF0393.1615	315/300	322,54 €	1



Falange PP  
Flange PP



Brida PP  
Bride PP

Ref.		€/Un.	
WF0392.5004	32/40	20,71 €	1
WF0392.5005	40/50	26,34 €	1
WF0392.5006	50/40	30,31 €	1
WF0392.5007	63/50	35,23 €	1
WF0392.5008	75/65	39,14 €	1
WF0392.5009	90/80	46,46 €	1
WF0392.5010	110/100	60,63 €	1
WF0392.5011	125/100	60,63 €	1



Taco Reparação Furo  
Hole Repairing Plug



Tapón Reparador  
Tampon p/ Reparation Trou

Ref.		€/Un.	
WF0392.5101	7/11	0,32 €	10



Passamuros  
Wall Disk



Pasamuros  
Raccord Murale

Ref.		€/Un.	
WF0392.5201	1/2"	8,91 €	5



Placa Montagem  
Mounting Plate

Placa Montaje  
Plaque de Montage

Ref.		€/Un.	
WF0392.5401		6,54 €	1



Matrizes  
Welding Tool

Matrices  
Matrices

Matriz p/ Enxerto  
Welding Tool f/ Saddles

Matriz p/ Injerto  
Matrice p/ Raccord Selle

Matriz reparação  
Repairing Bush

Matriz Reparación  
Matrice Reparation

Ref.		€/Un.	
WF0394.0102	20	41,46 €	1
WF0394.0103	25	48,20 €	1
WF0394.0104	32	51,23 €	1
WF0394.0105	40	70,80 €	1
WF0394.0106	50	78,51 €	1
WF0394.0107	63	96,26 €	1
WF0394.0108	75	120,49 €	1
WF0394.0109	90	198,43 €	1
WF0394.0110	110	284,29 €	1
WF0394.0111	125	313,29 €	1

Ref.		€/Un.	
WF0394.0205	40	84,80 €	1
WF0394.0206	50	84,80 €	1
WF0394.0207	63	84,80 €	1
WF0394.0208	75	84,80 €	1
WF0394.0209	90	84,80 €	1
WF0394.0210	110	84,80 €	1
WF0394.0211	125	112,06 €	1

Ref.		€/Un.	
WF0394.0401	7	63,29 €	1
WF0394.0402	11	63,29 €	1



Fresadora  
Chamfering Device

Fresadora  
Fraiseuse

Tampão Ensaio  
Test Plug

Tapón Ensaio  
Tampon d'Essai

Broca  
Drill

Broca  
Foret

Ref.		€/Un.	
WF0394.0603	25	84,97 €	1

Ref.			€/Un.	
WF0392.5501	1/2"	●	0,52 €	25
WF0392.5502	1/2"	●	1,01 €	25

Ref.		€/Un.	
WF0394.0503	25	79,11 €	1
WF0394.0504	32	159,71 €	1
WF0394.0505	40	185,00 €	1
WF0394.0506	50	239,71 €	1
WF0394.0507	63	277,14 €	1



Tesoura PP-R  
PP-R Cutting Plier

Tijera PP-R  
Coupe-Tube PP-R

Corta-Tubos  
Pipe Cutter

Corta-Tubos  
Coupe-Tubes



Ref.		€/Un.	
0390.5309	0-40	10,50 €	1

Ref.		€/Un.	
WF0394.1001	50-125	322,03 €	1



Polifusora Completa  
Polyfuser



Polifusora Completa  
Polyfuseur

Ref.		€/Un.	
0390.5151	20-63	<b>115,00 €</b>	1



Polifusora c/ Soporte  
Polifuser w/ Stand

Polifusor c/ Soporte  
Polyfuseur a/ Chevalet

Ref.		€/Un.	
WF0394.1201	16-63	<b>402,51 €</b>	1

Matrizes não incluídas  
Matrices no incluidas  
Welding tools not included  
Matrices non inclus



Polifusora c/ Soporte  
Polifuser w/ Stand

Polifusor c/ Soporte  
Polyfuseur a/ Chevalet



Ref.		€/Un.	
WF0394.1301	25-125	<b>815,09 €</b>	1

Matrizes não incluídas  
Matrices no incluidas  
Welding tools not included  
Matrices non inclus



Polifusor Banco  
Bench Welding



Polifusora de Banco  
Polyfuseur

Ref.		€/Un.	
WF0394.1401	25-125		1



Polifusora Topo a Topo  
Butt Welding Machine



Polifusora Tope a Tope  
Polyfuseur Bout à Bout

Ref.		€/Un.	
WF0394.1701	160-315		1



Suporte Soldadura  
Welding Fig

Suporte Soldadura  
Soudage Gabarit

Ref.		€/Un.	
WF0394.1501	63-125		1



Suporte Tubo  
Pipe Support

Suporte Tubo  
Support Tube

Ref.		€/Un.	
WF0394.1601			1



Polifusor Electrosoldável  
Electrofusion Welding Machine

Polifusor Electrosoldable  
Polyfuseur p/ Manchons Electriques

Ref.		€/Un.	
WF0394.1801			1





## Resistente aos agentes químicos

Resistente a los agentes químicos  
Resistant to chemical agents  
Résistant aux agents chimiques



## Atóxico

Atóxico  
Atoxic  
Atoxicité



## Isolamento acústico

Aislamiento acústico  
Acoustic insulation  
Isolation acoustique



## Baixa perda de carga

Baja pérdida de carga  
Short loss of load  
Basse perte de charge



## Resistência elevada à condução eléctrica

Resistencia elevada a la conducción eléctrica  
High resistance to electric conduction  
Haute résistance à la conduction électrique



## Resistente ao gelo

Resistente al hielo  
Frost resistant  
Résistant au gel



## Resistente à abrasão e corrosão

Resistente a la abrasión y corrosión  
Resistant to abrasion and corrosion  
Résistant à l'abrasion et à la corrosion



## Baixa condutividade térmica

Baja conductividad térmica  
Low thermal conductivity  
Basse conductivité thermique

## Tratamento Correto dos Sistemas de Tubagem

Tratamiento Correcto de los sistemas de tuberías | Correct Pipe System Handling | Traitement correct des systèmes de tubes



### Pouse os tubos com cuidado.

Coloque los tubos con cuidado.  
Put the pipes down carefully.  
Placez délicatement les tubes.



### Use apenas as ferramentas adequadas para cortar os tubos.

Utilice herramientas adecuadas para cortar los tubos.  
Use only the proper tools to cut the pipes.  
Utilisez uniquement les outils appropriés pour couper les tubes.



### Correções no alinhamento até 5° em relação ao eixo do tubo devem ser feitas imediatamente após a junção.

Correcciones hasta 5° en relación al eje del tubo deben ser hechas inmediatamente después de la unión.  
Alignment corrections up to 5° relative to the axis of the pipe can be carried out immediately after joining.  
Corrections d'alignement jusqu'à 5° par rapport à l'axe du tube peuvent être réalisées immédiatement après avoir rejoint.



### Armazenar protegidos do sol e da chuva.

Almacenar protegidos del sol y la lluvia.  
Store protected from sun and rain.  
Stocker à l'abri du soleil et de la pluie.



### Cobrir os tubos em risco para prevenir danos.

Cubrir los tubos para evitar daños.  
Cover pipes at risk to prevent damage.  
Couvrir les tubes à risque pour prévenir les dommages.



### Evitar impactos fortes nas extremidades dos tubos.

Evitar impactos en las extremidades de los tubos.  
Avoid hard knocks or impacts at the end of the pipes.  
Évitez les coups ou chocs durs à l'extrémité des tubes.



### Não usar tubos que estejam danificados ou rachados na superfície de contacto.

No utilizar tubos que estén dañados o rajados.  
Do not use pipes which are damaged or cracked at the interface.  
Ne pas utiliser des tubes qui sont endommagés ou fissurés à l'interface.



### Não torcer/rodar nem o tubo nem o fitting depois de juntar.

No girar ni el tubo ni el fitting después de unir.  
Do not twist either pipe or fitting after joining together.  
Ne pas tordre soit tube ou raccord après avoir rejoint ensemble.



### Não expor a raios UV por longos períodos de tempo.

No exponer a rayos UV por largos períodos de tiempo.  
Do not expose to UV-radiation for any extended period of time.  
Ne pas exposer à un rayonnement UV pour toute période de temps prolongée.



### Providenciar proteção contra impactos fortes e queda de objectos.

Proteja los tubos contra impactos y caída de objetos.  
Provide protection against hard impacts and falling stones on the site.  
Fournir une protection contre les chocs et les chutes d'objets durs.

# 2.9

## Tube Inox e Acessórios Bicone

Tubos Inox y Accesorios de Compresión

S. S. Pipe and Compression Fittings

Tuyau Inox et Raccord Compression

### Latão Niquelado

Latón Niquelado

Nickel Plated Brass

Laiton Nickelé

### Rosca Paralela ISO228/1

Rosca Paralela ISO228/1



Parallel Thread ISO228/1

Filetage Parallèle ISO228/1



4 m

947  
Tubo Aço Inox  
Tubo Acero Inox  
Stainless Steel Pipe  
Tube en Acier Inoxydable

Ref.		€/Un.	
0947.0203	15	<b>2,00 €</b>	40
0947.0204	18	<b>2,90 €</b>	40
0947.0205	22	<b>3,50 €</b>	40



460  
União Simples  
Unión Simple  
Straight Coupler  
Machon Double

Ref.		€/Un.		
0460.0102	12	<b>2,48 €</b>	10	200
0460.0104	15	<b>1,79 €</b>	10	250
0460.0106	18	<b>2,58 €</b>	10	160
0460.0107	22	<b>3,89 €</b>	10	160
0460.0108	28	<b>7,54 €</b>	5	50
0460.0109	35	<b>15,63 €</b>	1	40
0460.0110	42	<b>21,80 €</b>	1	30

# Acessórios Bicone

Accesorios Compresión | Compression Fittings | Raccord Compression



**461**  
**União Redução**  
 Unión Reducción  
 Reducing Straight Coupler  
 Manchon Double Redución

Ref.		€/Un.		
0461.0104	18x15	<b>2,00 €</b>	10	100
0461.0105	22x15	<b>4,96 €</b>	10	100
0461.0106	22x18	<b>4,97 €</b>	10	100
0461.0107	28x22	<b>7,73 €</b>	1	50
0461.0108	35x28	<b>17,33 €</b>	1	50
0461.0109	42x35	<b>19,00 €</b>	1	50
0461.0110	35x22	<b>17,68 €</b>	1	50



**462**  
**União Cruzamento**  
 Curva Puente  
 Bypass Bend  
 Passage Pont

Ref.		€/Un.		
0462.0104	15	<b>10,53 €</b>	10	100
0462.0106	18	<b>7,00 €</b>	10	100
0462.0107	22	<b>7,50 €</b>	10	100



**463**  
**Casquilho Macho**  
 Unión Macho  
 Straight M Coupler  
 Machon M

Ref.		€/Un.		
0463.0112	1/2x12	<b>2,23 €</b>	10	200
0463.0114	1/2x15	<b>1,47 €</b>	10	250
0463.0116	1/2x18	<b>2,15 €</b>	10	250
0463.0117	1/2x22	<b>3,89 €</b>	10	100
0463.0124	3/4x15	<b>2,37 €</b>	10	250
0463.0126	3/4x18	<b>2,37 €</b>	10	200
0463.0127	3/4x22	<b>2,63 €</b>	10	160
0463.0128	3/4x28	<b>6,46 €</b>	10	50
0463.0137	1x22	<b>4,96 €</b>	10	100
0463.0138	1x28	<b>5,11 €</b>	5	50
0463.0149	11/4x35	<b>13,64 €</b>	1	40
0463.0160	11/2x42	<b>16,44 €</b>	1	20



**464**  
**Casquilho Fêmea**  
 Unión Hembra  
 Straight F Coupler  
 Machon F

Ref.		€/Un.		
0464.0112	1/2x12	<b>2,72 €</b>	10	200
0464.0114	1/2x15	<b>1,74 €</b>	10	250
0464.0116	1/2x18	<b>2,21 €</b>	10	200
0464.0117	1/2x22	<b>3,00 €</b>	10	100
0464.0124	3/4x15	<b>3,15 €</b>	10	250
0464.0126	3/4x18	<b>3,68 €</b>	10	200
0464.0127	3/4x22	<b>3,42 €</b>	10	160
0464.0128	3/4x28	<b>8,51 €</b>	10	100
0464.0137	1x22	<b>5,83 €</b>	10	100
0464.0138	1x28	<b>5,56 €</b>	5	50
0464.0149	11/4x35	<b>12,14 €</b>	5	50
0464.0160	11/2x42	<b>17,24 €</b>	1	30



**465**  
**Joelho 90°**  
 Codo 90°  
 Elbow 90°  
 Coude 90°

Ref.		€/Un.		
0465.0102	12	<b>3,69 €</b>	10	200
0465.0104	15	<b>2,11 €</b>	10	200
0465.0106	18	<b>2,79 €</b>	10	120
0465.0107	22	<b>3,89 €</b>	10	120
0465.0108	28	<b>8,19 €</b>	5	50
0465.0109	35	<b>17,40 €</b>	1	30
0465.0110	42	<b>29,03 €</b>	1	20



**466**  
**Joelho 90° Redução**  
 Codo 90° Reducción  
 Reducing Elbow 90°  
 Coude 90° Reduit

Ref.		€/Un.		
0466.0104	18x15	<b>4,42 €</b>	10	100
0466.0105	22x15	<b>5,43 €</b>	10	100
0466.0106	22x18	<b>5,24 €</b>	10	100
0466.0107	28x22	<b>7,21 €</b>	1	50



# Acessórios Bicone

Accesorios Compresión | Compression Fittings | Raccord Compression



467  
Joelho 90° Macho  
Codo 90° Hembra  
Elbow 90° Male  
Coude 90° Mâle

Ref.		€/Un.		
0467.0102	1/2x12	<b>3,68 €</b>	10	200
0467.0104	1/2x15	<b>1,80 €</b>	10	250
0467.0106	1/2x18	<b>2,53 €</b>	10	200
0467.0107	1/2x22	<b>5,33 €</b>	10	100
0467.0124	3/4x15	<b>4,00 €</b>	10	160
0467.0126	3/4x18	<b>4,16 €</b>	10	160
0467.0127	3/4x22	<b>4,16 €</b>	10	120
0467.0128	3/4x28	<b>8,23 €</b>	10	100
0467.0137	1x22	<b>8,66 €</b>	5	100
0467.0138	1x28	<b>8,66 €</b>	5	50



468  
Joelho 90° Fêmea  
Codo 90° Hembra  
Elbow 90° Female  
Coude 90° Femelle

Ref.		€/Un.		
0468.0112	1/2x12	<b>3,22 €</b>	10	200
0468.0114	1/2x15	<b>1,79 €</b>	10	250
0468.0116	1/2x18	<b>3,30 €</b>	10	150
0468.0117	1/2x22	<b>4,35 €</b>	10	100
0468.0124	3/4x15	<b>5,43 €</b>	10	100
0468.0126	3/4x18	<b>4,97 €</b>	10	160
0468.0127	3/4x22	<b>4,47 €</b>	10	80
0468.0128	3/4x28	<b>9,91 €</b>	10	100
0468.0137	1x22	<b>7,95 €</b>	10	100
0468.0138	1x28	<b>8,18 €</b>	10	50
0468.0149	1 1/4x35	<b>16,36 €</b>	5	30
0468.0160	1 1/2x42	<b>24,32 €</b>	5	20



469  
Joelho c/ Pater  
Codo Placa  
Wall-Plated Elbow  
Coude Murale

Ref.		€/Un.		
0469.0114	1/2x15	<b>3,47 €</b>	10	100
0469.0116	1/2x18	<b>4,00 €</b>	10	100
0469.0117	1/2x22	<b>8,67 €</b>	10	50
0469.0124	3/4x15	<b>8,44 €</b>	10	100
0469.0126	3/4x18	<b>7,99 €</b>	10	100
0469.0127	3/4x22	<b>8,93 €</b>	10	50



470  
Tê Simples  
Te Igual  
Equal Tee  
Té Egal

Ref.		€/Un.		
0470.0102	12	<b>4,29 €</b>	10	200
0470.0104	15	<b>3,00 €</b>	10	150
0470.0106	18	<b>5,32 €</b>	10	160
0470.0107	22	<b>7,37 €</b>	10	160
0470.0108	28	<b>6,84 €</b>	10	100
0470.0109	35	<b>27,46 €</b>	1	25
0470.0110	42	<b>39,62 €</b>	1	20



475  
Tê Fêmea  
Te Hembra  
Tee F  
Té F

Ref.		€/Un.		
0475.0114	15x1/2x15	<b>3,00 €</b>	10	100
0475.0124	15x3/4x15	<b>11,64 €</b>	10	100
0475.0136	18x1/2x18	<b>5,30 €</b>	10	100
0475.0146	18x3/4x18	<b>6,66 €</b>	10	100
0475.0157	22x1/2x22	<b>7,21 €</b>	10	50
0475.0167	22x3/4x22	<b>8,92 €</b>	10	50
0475.0168	28x1/2x28	<b>10,87 €</b>	5	25
0475.0178	28x3/4x28	<b>13,21 €</b>	5	25
0475.0188	28x1x28	<b>17,34 €</b>	5	25



473  
Tê Redução Extremo  
Te Reducción Extremo  
Reducing Side Tee  
Té Reduit Coté

Ref.		€/Un.		
0473.0104	18x18x15	<b>6,76 €</b>	10	100
0473.0114	22x22x15	<b>6,68 €</b>	5	50
0473.0116	22x22x18	<b>8,80 €</b>	5	50
0473.0124	28x28x15	<b>14,86 €</b>	5	50
0473.0127	28x28x22	<b>12,62 €</b>	5	50





# Acessórios Bicone

Accesórios Compresión / Compression Fittings / Raccord Compression



471  
Tê Redução Centro  
Te Reducción Centro  
Reducing Central Tee  
Té Reduit Centre

Ref.		€/Un.		
0471.0102	15x12x15	<b>6,45 €</b>	10	100
0471.0112	18x12x18	<b>9,56 €</b>	10	100
0471.0114	18x15x18	<b>5,00 €</b>	10	100
0471.0124	22x15x22	<b>5,43 €</b>	10	50
0471.0126	22x18x22	<b>7,95 €</b>	10	50
0471.0134	28x15x28	<b>9,17 €</b>	10	50
0471.0136	28x18x28	<b>15,99 €</b>	10	50
0471.0137	28x22x28	<b>10,40 €</b>	10	40
0471.0144	35x15x35	<b>26,98 €</b>	1	25
0471.0147	35x22x35	<b>29,20 €</b>	1	25
0471.0148	35x28x35	<b>29,20 €</b>	1	25
0471.0157	42x22x42	<b>40,09 €</b>	1	20
0471.0158	42x28x42	<b>38,09 €</b>	1	20
0471.0159	42x35x42	<b>38,09 €</b>	1	20



476  
Jogo Redução  
Kit Reducción  
Reducing Kit  
Kit Reduit

Ref.		€/Un.		
0476.0102	15x12	<b>2,46 €</b>	10	100
0476.0103	18x12	<b>2,75 €</b>	10	100
0476.0104	18x15	<b>2,81 €</b>	10	100
0476.0105	22x15	<b>2,86 €</b>	10	100
0476.0106	22x18	<b>3,31 €</b>	10	100
0476.0107	28x15	<b>3,84 €</b>	10	100
0476.0108	28x18	<b>3,84 €</b>	5	100
0476.0109	28x22	<b>3,84 €</b>	1	100
0476.0110	35x15	<b>7,42 €</b>	5	100
0476.0111	35x18	<b>7,93 €</b>	5	100
0476.0112	35x22	<b>7,93 €</b>	5	100
0476.0113	35x28	<b>7,93 €</b>	5	100
0476.0115	42x22	<b>10,65 €</b>	1	50
0476.0116	42x28	<b>10,65 €</b>	1	50
0476.0117	42x35	<b>10,65 €</b>	1	50





478  
Anilha Compressão  
Anilla Compresión  
Compression Ring  
Anneau de Compression

Ref.		€/Un.		
0478.0102	12	<b>0,32 €</b>	10	100
0478.0104	15	<b>0,41 €</b>	10	100
0478.0106	18	<b>0,42 €</b>	10	100
0478.0107	22	<b>0,53 €</b>	10	100
0478.0108	28	<b>0,76 €</b>	10	50
0478.0109	35	<b>1,49 €</b>	10	50
0478.0110	42	<b>1,56 €</b>	10	20



TT323  
Passador Esfera  
Válvula Esfera  
Ball Valve  
Vanne Sferique



Ref.		€/Un.	
6023.0104	15	<b>6,38 €</b>	12
6023.0105	18	<b>7,98 €</b>	12
6023.0106	22	<b>11,17 €</b>	6
0323.0108	28	<b>15,00 €</b>	6

# 2.10

## Caleira e Acessórios

Canalón y Accesorios | Gutter and Accessories | Gouttière et Accessoires

# FERR PLAST

### Cores Disponíveis

Colores Disponibles

Available Colors

Couleurs Disponibles



### Branco

Blanco

White

Blanc



25

### Cinza (RAL 7037)

Cinza (RAL 7037)

Grey (RAL 7037)

Gris (RAL 7037)



25

33

## Caleira Circular e Acessórios

Canalón Circular y Accesorios | Circular Gutter and Accessories | Gouttière Demi-Rond et Accessoires



4 m

Caleira PVC Circular

Canalón Circular PVC

Gutter

Gouttière

Ref.			€/m	
0942.0101	25	●	3,82 €	40 m
0942.0102	33	●	7,54 €	20 m
0942.9801	25	○	4,38 €	40 m



União Simples

Enlace

Union

Jonction

Ref.			€/Un.	
0942.1001	25	●	2,35 €	36
0942.1002	33	●	4,06 €	16
0942.9805	25	○	2,72 €	36



Curva Interior 90°

Ángulo Interior 90°

Internal Angle 90°

Angle Interieur 90°

Ref.			€/Un.	
0942.2001	25	●	8,22 €	10
0942.2002	33	●	26,95 €	10
0942.9815	25	○	9,46 €	10



Curva Exterior 90°

Ángulo Exterior 90°

External Angle 90°

Angle Exterieur 90°

Ref.			€/Un.	
0942.2501	25	●	7,71 €	10
0942.2502	33	●	25,14 €	10
0942.9810	25	○	8,88 €	10



Topo c/ Descida Direita

Tapa c/ Bajada Derecha

Right Outlet Stopend

Naissance Droit

Ref.			€/Un.	
0942.3001	25	●	6,86 €	12
0942.3002	33	●	11,90 €	14
0942.9825	25	○	7,86 €	12



Topo c/ Descida Esquerda

Tapa c/ Bajada Izquierda

Left Outlet Stopend

Naissance Gaudre

Ref.			€/Un.	
0942.3501	25	●	6,86 €	12
0942.3502	33	●	11,90 €	14
0942.9830	25	○	7,86 €	12

# Caleira Circular e Acessórios

Canalón Circular y Accesorios | Circular Gutter and Accessories | Gouttière Demi-Rond et Accessoires



União c/ Descarga  
Unión c/ Bajante  
Central Outlet  
Naissance Centrale

Ref.			€/Un.	
0942.4001	25	●	5,49 €	10
0942.4002	33	●	8,85 €	14
0942.9841	25	○	6,03 €	10



Topo Simples  
Tapón Simples  
Stopend  
Fond

Ref.			€/Un.	
0942.5001	25	●	0,92 €	60
0942.5002	33	●	2,30 €	50
0942.9861	25	○	1,09 €	60



Suporte Simples  
Gancho Circular  
Fascia Bracket  
Crochet Bandeau

Ref.			€/Un.	
0942.8201	25	●	1,09 €	60
0942.8202	33	●	1,91 €	40
0942.9831	25	○	1,29 €	60



Suporte Galvanizado  
Soporte Galvanizado  
Galvanized Bracket  
Crochet Galvanisée

Ref.		€/Un.	
0942.9001	25	1,70 €	100
0942.9002	33	2,47 €	50



3 m

Tubo Descarga  
Tubo Bajante  
Downpipe  
Tube de Descente

UNE  
EN  
12200

Ref.			€/Un.	
0942.9877	75	○	12,20 €	15 m
0943.7001	90	○	17,25 €	15 m



União F/F  
Manguito H/H  
Socket F/F  
Manchon F/F



Ref.			€/Un.	
0943.2000	75	○	3,06 €	40
0943.2001	90	○	4,32 €	55



União Redução  
Reducción Excéntrica  
Eccentric Reduction  
Réduction Excentrique

Ref.			€/Un.	
0942.8501	90x75	●	2,51 €	36
0942.9865	90x75	○	3,32 €	36
0942.8502	110x90	●	3,44 €	42
0942.8503	125x110	●	8,78 €	35



Curva Circular 87°  
Codo Circular 87°  
Elbow 87°  
Coude 87°



Ref.			€/Un.	
0942.9881	75	○	4,68 €	40
0943.6001	90	○	6,44 €	25



Forquilha Simples 45°  
Injerto 45°  
Brande 45°  
Culotte 45°



Ref.			€/Un.	
0943.6009	75	○	7,08 €	24
0943.6010	90	○	9,45 €	30

# Caieira Circular e Acessórios

Canalón Circular y Accesorios | Circular Gutter and Accessories | Gouttière Demi-Rond et Accessoires



**Curva Circular 45°**  
Codo Circular 45°  
Elbow 45°  
Coude 45°



Ref.			€/Mt.	
0943.6000	75	○	<b>3,83 €</b>	60
0943.6002	90	○	<b>5,11 €</b>	36



**Abraçadeira PVC**  
Abrazadera Bajante  
Clip  
Collier Descente

Ref.			€/Mt.	
0943.7203	75	○	<b>1,47 €</b>	35
0943.7202	90	○	<b>1,71 €</b>	60



**Capiteis**  
Toma Gárgola  
Hopper Head  
Tête Trénie

Ref.			€/Mt.	
0943.9010	75	●	<b>6,51 €</b>	10
0943.9011	90	●	<b>6,51 €</b>	10
0943.9310	75	○	<b>7,37 €</b>	10
0943.9311	90	○	<b>7,37 €</b>	10



**Placa Esquadria**  
Pletina Escuadra  
Angle Plate  
Plaque Angulaire

Ref.	€/Un.	
0943.7401	<b>1,30 €</b>	100



**Placa Reta**  
Pletina Recta  
Straight Plate  
Plaque Droite

Ref.	€/Un.	
0943.7402	<b>1,04 €</b>	200



**Suporte Coberta Ondulada**  
Soporte Cubierta Ondulado  
Bracket  
Etier p/ Plaque Ondulée

Ref.	€/Un.	
0943.7302	<b>1,23 €</b>	100



# Caleira Quadrada e Acessórios

Canalón Cuadrada y Accesorios | Square Gutter and Accessories | Gouttière Carré et Accessoires

## Caleira

Canalón  
Gutter  
Gouttière

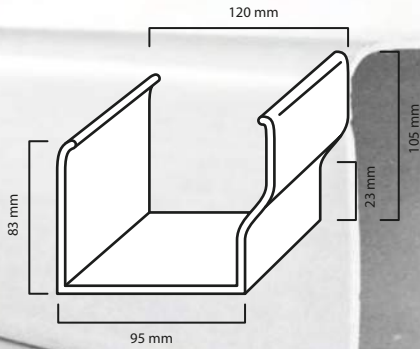

## Tubo Descarga

Tubo Bajante  
Downpipe  
Tube de Descente

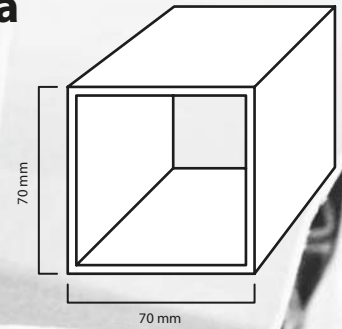

**Branco EN607**   
Blanco | White | Blanc

**FERR PLAST**

## 4 m

Caleira PVC  
Canalón PVC  
PVC Gutter  
Gouttière

União Simples  
Enlace  
Union Bracket  
Jonction



União c/ Descarga  
Bajante Central  
Central Outlet  
Naissance Centrale

Curva 90°  
Ángulo 90°  
Angle 90°  
Angle 90°

Ref.	€/m	
0943.0101	11,08 €	16 m

Ref.	€/Un.	
0943.1001	7,27 €	30

Ref.	€/Un.	
0943.1003	11,39 €	6

Ref.		€/Un.	
0943.6501	int	11,10 €	8
0943.6502	ext	10,60 €	8

Curva Interior c/ Descarga  
Ángulo Interior c/ Bajada  
Outlet Internal Angle  
Angle Interieur a/ Décharge

Curva Exterior c/ Descarga  
Ángulo Exterior c/ Bajada  
Outlet External Angle  
Angle Exterior a/ Décharge

Topo c/ Descarga Esquerda  
Bajada Izquierda  
Left Outlet Stopend  
Naissance Gauche

Topo c/ Descarga Direita  
Bajada Derecha  
Right Outlet Stopend  
Naissance Droit

Ref.	€/Un.	
0943.6601	14,38 €	18

Ref.	€/Un.	
0943.6602	14,10 €	18

Ref.	€/Un.	
0943.6802	10,90 €	8

Ref.	€/Un.	
0943.6801	10,90 €	8

# Caleira Quadrada e Acessórios

Canalón Cuadrada y Accesorios | Square Gutter and Accessories | Gouttière Carré et Accessoires



**Gancho Fixo**  
Gancho Fijo  
Bracket  
Crochet

Ref.	€/Un.	
0943.7110	1,62 €	75



**Topo Esquerdo**  
Tapa Izquierda  
Left Stopend  
Fond Gauche

Ref.	€/Un.	
0943.6702	2,84 €	50



**Topo Direito**  
Tapa Derecha  
Right Stopend  
Fond Droit

Ref.	€/Un.	
0943.6701	2,84 €	50



**Suporte Extensível**  
Gancho Telescópico  
Telescopic Bracket  
Support Extensible

Ref.	€/Un.	
0943.7303	3,69 €	45



**Suporte Telha**  
Soporte Teja  
Tile Bracket  
Etrier p/ Tuíte

Ref.	€/Un.	
0943.7301	1,55 €	100



**Suporte Coberta Ondulada**  
Soporte Cubierta Ondulado  
Bracket  
Etier p/ Plaque Ondulée

Ref.	€/Un.	
0943.7302	1,23 €	100



**Placa Esquadria**  
Pletina Escuadra  
Angle Plate  
Plaque Angulaire

Ref.	€/Un.	
0943.7401	1,30 €	100



**Placa Reta**  
Pletina Recta  
Straight Plate  
Plaque Droite

Ref.	€/Un.	
0943.7402	1,04 €	200

## 4 m



**Tubo Quadrado Descarga**  
Tubo Cuadrado  
Square Downpipe  
Descente Carré

Ref.	€/Un.	
0943.6901	26,75 €	16 m



**União Quadrada**  
Manguito Cuadrado  
Square Socket  
Manchon Carré

Ref.	€/Un.	
0943.1002	3,27 €	45



**Joelho Quadrado 45°**  
Codo Cuadrado 45°  
Square Elbow 45°  
Coude Carré 45°

Ref.	€/Un.	
0943.6004	4,84 €	27



**Joelho Quadrado 87°**  
Codo Cuadrado 87°  
Square Elbow 87°  
Coude Carré 87°

Ref.	€/Un.	
0943.6003	5,73 €	22



**Forquilha Quadrada 45°**  
Injerto Cuadrado 45°  
Branch 45°  
Culotte 45°

Ref.	€/Un.	
0943.6104	9,63 €	10



**Remate Baixada**  
Remate Bajante  
Shoe  
Pied Dechute

Ref.	€/Un.	
0943.7210	5,74 €	30



**Adaptador Quadrado Circular**  
Adaptador Cuadrado Circular  
Drain Adaptor  
Adapteur

Ref.	€/Un.	
0943.7101	3,77 €	24



**Abraçadeira Tubo Quadrado**  
Abrazadera Tubo Cuadrado  
Clip  
Collier Descente

Ref.	€/Un.	
0943.7201	1,31 €	75

# 2.11

## Caixas Sumidouras



**Preços alterados!**

**Consulte os nossos serviços comerciais  
ou a tabela Jimten 17 Ed. 31 | Abril 2017  
em vigor desde 01/06/2017**



Autolimpicante  
Grancaudal



Fácil acceso / Fácil acesso



## S-246



Sumidero sifónico, salida vertical macho encolar, rejilla PVC.  
Sumidouro sifónico, saída vertical macho colar, grelha PVC.

Ref.	Ø Salida Ø Saída	Rejilla Grelha		€/Un.	
24060	50	150 x 150	PVC	20	20
24170	50	150 x 150	Ac. Inox	2	2
24064	50	150 x 150	PP	20	20
24100	75	200 x 200	PVC	15	15
24180	75	200 x 200	Ac. inox	2	2
24104	75	200 x 200	PP	15	15
24101	75	200 x 200	PVC	15	15
24080	90	250 x 250	PVC	10	10
24190	90	250 x 250	Ac. inox	2	2
24084	90	250 x 250	PP	10	10
24090	110	250 x 250	PVC	10	10
24200	110	250 x 250	Ac. inox	2	2
24094	110	250 x 250	PP	10	10

## S-247



Caldereta sifónica extensible, salida vertical macho encolar.  
Caixa sifónica, saída vertical macho colar.

Ref.	Ø Salida Ø Saída	Rejilla Grelha		€/Un.	
08182	75	150 x 150	PVC	10	10
08183	75	150 x 150	Ac.inox	2	2
08180	75	150 x 150	PP	10	10
08192	90	200 x 200	PVC	10	10
08193	90	200 x 200	Ac. Inox	2	2
08190	90	200 x 200	PP	10	10
08242	90	250 x 250	PVC	6	6
08240	90	250 x 250	PP	6	6
08202	110	200 x 200	PVC	6	6
08203	110	200 x 200	Ac. Inox	2	2
08200	110	200 x 200	PP	6	6
08252	110	250 x 250	PVC	5	5
08253	110	250 x 250	Ac. Inox	2	2
08250	110	250 x 250	PP	5	5
08300	125	300 x 300	PP	4	4

## S-248



Caldereta sifónica extensible, salida horizontal macho encolar.  
Caixa sifónica, saída horizontal macho colar.

Ref.	Ø Salida Ø Saída	Rejilla Grelha		€/Un.	
08212	75	150 x 150	PVC	10	10
08213	75	150 x 150	Ac. Inox	2	2
08210	75	150 x 150	PP	10	10
08222	90	200 x 200	PVC	10	10
08223	90	200 x 200	Ac. Inox	2	2
08220	90	200 x 200	PP	10	10
08282	110	200 x 200	PVC	10	10
08283	110	200 x 200	Ac. Inox	2	2
08280	110	200 x 200	PP	10	10
08232	110	250 x 250	PVC	5	5
08233	110	250 x 250	Ac. Inox	2	2
08230	110	250 x 250	PP	5	5
08390	125	300 x 300	PP	2	2

## S-192



Sumidero sifónico, salida vertical hembra encolar.  
Sumidouro sifónico, saída vertical fêmea colar.

Ref.	Ø Salida Ø Saída	Rejilla Grelha		€/Un.	
24048	50 x 40	105 x 105	Ac. Inox	25	25
24058	50 x 40	105 x 105	PVC	25	25

## S-191



Sumidero sifónico, salida horizontal hembra encolar.  
Sumidouro sifónico, saída horizontal fêmea colar.

Ref.	Ø Salida Ø Saída	Rejilla Grelha		€/Un.	
24028	50 x 40	105 x 105	Ac. Inox	25	25
24038	50 x 40	105 x 105	PVC	25	25



# 2.12

## Contadores de Água e Acessórios

Contadores de Agua y Accesorios  
Water Meters and Accessories  
Compteur d'Eau et Accessoires

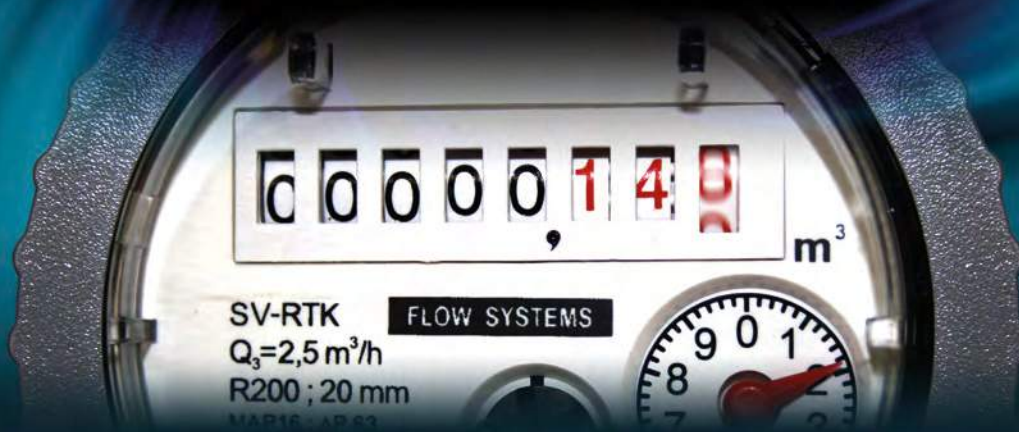

9903  
Contador de Água  
Water Meter  
Medidor de Agua  
Compteur d'Eau

Ref.		€/Un.	
9903.0044	1/2	71,00 €	10
9903.0045	3/4	74,00 €	10
9903.0046	1	92,00 €	10
9903.0047	1 1/4	205,00 €	10
9903.0048	1 1/2	312,00 €	10
9903.0049	2	387,00 €	10



197  
Suporte Contador  
Water Meter Support  
Soporte Medidor  
Support p/ Compteur

Ref.		€/Un.		
0197.0101	1/2x3/4	13,22 €	5	50
0197.0102	3/4x1	23,02 €	5	50
0197.0103	1x1 1/4	69,95 €	2	20
0197.0104	1 1/4x1 1/2	99,52 €	2	10
0197.0105	1 1/2x2	191,65 €	2	10



198  
Junção p/ Contador  
Water Meter Connector  
Racor p/ Medidor  
Raccord p/ Compteur

Ref.		€/Un.		
0198.0003	1/2x3/4	2,20 €	10	100
0198.0004	3/4x1	3,75 €	10	100



196C  
Caixa Contador Água  
Water Meter Box  
Caja Medidor Agua  
Boîte Compteur d'Eau

Ref.		€/Un.	
0196.0103	50x35	15,55 €	10
0196.0104	60x35	15,80 €	10



196P  
Porta com Aro  
Door with Frame  
Puerta con Aro  
Porte avec Cerceau

Ref.		€/Un.	
0196.0013	50x35	12,60 €	10
0196.0014	60x35	12,86 €	10



196CH  
Chave  
Key  
Llave  
Clé

Ref.	€/Un.		
0196.0604	0,30 €	10	100

# Contadores de Água e Acessórios

Contadores de Agua y Accesorios / Water Meters and Accessories / Compteur d'Eau et Accessoires



768  
Acessórios Suporte  
Bracket Fittings

Accesorios Soporte  
Raccord p/ Support

Ref.		€/Un.		
0768.0101	1/2x3/4	9,75 €	5	100
0768.0102	3/4x1	18,35 €	5	100
0768.0103	1x11/4	67,54 €	5	50
0768.0104	11/4x11/2	94,19 €	2	20
0768.0105	11/2x2	184,66 €	2	10



768E  
Junção Extensível  
Telescopic Connector

Racord Telescópico  
Raccord Telescopiqué

Ref.		€/Un.		
0768.0111	1/2x3/4	5,65 €	10	100
0768.0112	3/4x1	10,45 €	10	100
0768.0113	1x11/4	37,41 €	5	50
0768.0114	11/4x11/2	55,38 €	5	20
0768.0115	11/2x2	109,12 €	5	10



768C  
Chapa p/ Suporte  
Support Plate

Chapa p/ Soporte  
Plaque pour Support

Ref.		€/Un.		
0768.0201	1/2x3/4	1,98 €		50
0768.0202	3/4x1	2,37 €		50
0768.0203	1x11/4	5,97 €		10
0768.0204	11/4x11/2	10,29 €		10
0768.0205	11/2x2	16,72 €		10

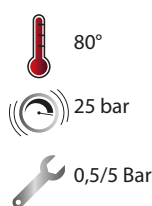

978  
Redutora de Pressão  
Pressure Reducer

Reductor de Presión  
Réducteur de Pression

Ref.		€/Un.		
0316.0103	1/2	25,10 €		20
0316.0104	3/4	27,50 €		20
0316.0105	1	44,15 €		10
0316.0106	11/4	73,00 €		4
0316.0107	11/2	75,50 €		4
0316.0108	2	139,00 €		4

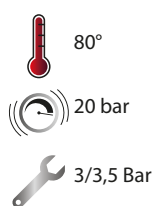

316F  
Redutora de Pressão  
Pressure Reducer

Reductor de Presión  
Réducteur de Pression

Ref.		€/Un.		
0316.0203	1/2	12,06 €		12

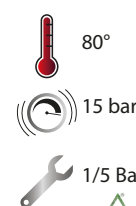

977  
Redutora de Pressão  
Pressure Reducer

Reductor de Presión  
Réducteur de Pression

Ref.		€/Un.		
0340.0302	1/2	17,00 €		8
0340.0303	3/4	18,00 €		8



TT303  
Passador Esfera Selar  
Válvula de Bola Cuadradillo  
Lockable Ball Valve  
Vanne Carrée Scellée

Ref.		€/Un.		
6003.0103	1/2	3,00 €		12
6003.0104	3/4	5,40 €		8
6003.0105	1	8,50 €		6
6003.0106	11/4	20,00 €		4
6003.0107	11/2	30,00 €		3
6003.0108	2	50,00 €		2



604  
Passador Esfera Selar  
Válvula de Bola Cuadradillo  
Lockable Ball Valve  
Vanne Carrée Scellée

Ref.		€/Un.		
0303.0103	1/2	5,12 €	20	80
0303.0104	3/4	7,06 €	14	56
0303.0105	1	10,50 €	10	40
0303.0106	11/4	20,00 €	4	16
0303.0107	11/2	30,00 €	3	12
0303.0108	2	50,00 €	2	8



245  
Passador Esfera com Retenção  
Válvula de Bola con Retención  
Lockable Ball Valve  
Vanne à Sphère avec Non-Vetour

Ref.		€/Un.		
0395.3103	11/4	55,00 €		4
0395.3104	11/2	75,00 €		2
0395.3105	2	120,00 €		1

# Contadores de Água e Acessórios

Contadores de Agua y Accesorios / Water Meters and Accessories / Compteur d'Eau et Accessoires

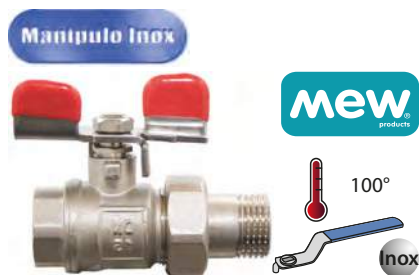

**TT326**  
Passador Esfera c/ Porca  
Válvula de bola c/ Tuerca  
Ball Valve w/ Loose Nut  
Vanne à Sphère e/ Écrou

Ref.		€/Un.	
6026.0003	1/2	4,00 €	12
6026.0004	3/4	6,70 €	10
6026.0005	1	10,50 €	10
6026.0023	1/2	4,00 €	12
6026.0024	3/4	6,70 €	10
6026.0025	1	10,50 €	10



**5201**  
Válvula Esfera c/ Porca Móvel  
Válvula de Bola c/ Racor Loco  
Ball Valve w/ Loose Nut  
Vanne à Sphère a/ Ecrou Tournant

Ref.		€/Un.	
0395.0103	1/2x3/4	13,05 €	14
0395.0104	3/4x3/4	15,30 €	12
0395.0106	1x1	23,00 €	8



**5251**  
Passador Esfera Rosca p/ PE  
Válvula de Bola Rosca p/ PE  
Water Meter Support  
Vanne à Sphère Vis p/ PE

Ref.		€/Un.	
0395.0403	20x3/4	16,30 €	10
0395.0404	25x3/4	17,95 €	10
0395.0405	32x3/4	33,25 €	6
0395.0406	32x1	34,60 €	6



**5301**  
Passador Esfera Esquadria Pm  
Válvula de Bola Escuadra RI  
Ball Angle Valve In  
Vanne à Sphère Em

Ref.		€/Un.	
0395.0603	1/2x3/4	17,35 €	15
0395.0604	3/4x3/4	17,90 €	8
0395.0605	3/4x1	25,55 €	6
0395.0606	1x1	26,60 €	4



**5551**  
Passador Esfera c/ Filtro  
Válvula de Bola c/ Filtro  
Ball Valve w/ Filter  
Vanne à Sphère a/ Filtre

Ref.		€/Un.	
0395.1703	1/2x3/4	20,65 €	4
0395.1704	3/4x3/4	21,75 €	4
0395.1706	1x1	33,70 €	4



**5204**  
Passador Esfera Porca Móvel  
Válvula de Bola Racor Loco  
Ball Valve Loose Nut  
Vanne à Sphère Ecrou Móbile

Ref.		€/Un.	
0328.0402	1/2x3/4	20,06 €	12
0328.0403	3/4x3/4	20,83 €	8
0328.0405	1x1	10,37 €	8



# 2.13

## Fixação, Vedação, Isolamento

Fijación, Sellado, Aislamento | Fixing, Sealing, Insulation | Fixation, Scelle, Isolation



192  
Kit Parafusos Lavatório  
Kit Tornillos Lavabo  
Wasbasin Screw Set  
Jeu Vis Lavabo

Ref. €/Un.  

0192.0101 0,60 € 15 150



195  
Kit Parafusos Sanita  
Kit Tornillos Inodoro  
Toilet Screw Set  
Jeu Vis Toilette

Ref. €/Un.  

0195.0101 1,00 € 25 250



Inox

195I  
Kit Parafusos Sanita Inox  
Kit Tornillos Inodoro Inox  
S. S. Toilet Screw Set  
Jeu Vis Toilette Inox

Ref. €/Un.  

0195.0105 2,50 € 25 250



195R  
Kit Parafusos Sanita ROCA  
Kit Tornillos Inodoro ROCA  
ROCA Toilet Screw Set  
Jeu Vis Toilette ROCA

Ref. €/Un.  

0195.0201 1,48 € 25 250

**HYDRAFIFX**  **25 años**

EXPERTOS EN FIJACIONES



250H  
Abraçadeira Hydrafix  
Abrazadera Hydrafix  
Hydrafix Clamp  
Collier Hydrafix

Ref.  €/Box 

0250.0401 15-18 44,80 € 200

0250.0403 20-25 47,69 € 150

0250.0405 25-32 36,91 € 100

**MULTI** tubo diâmetro  
fixação guias

Compatível com mais de 9 modelos de tubo;  
9 diâmetros desde Ø15 até Ø32;  
Pode ser fixado com parafuso M6 normal ou de pistola;  
Encaixa em guias 20 x 10, 25 x 7,5 e 27 x 18.



**MULTI** tubo diâmetro  
fijación guías

Compatible con más de 9 modelos de tubo;  
9 diámetros de Ø15 a Ø32;  
Puede fijarse con un tornillo M6 normal o de pistola;  
Encaja en guías 20 x 10, 25 x 7,5 y 27 x 18.

**MULTI** pipe diameter  
fixation rails

Compatible with over 9 pipe models;  
9 diameters from Ø15 to Ø32;  
Can be set with normal M6 screw or gun;  
Fits in guides 20 x 10, 25 x 7,5 and 27 x 18.

**MULTI** tuyau diamètre  
fixation guides

compatible avec plus de 9 modèles de tuyau;  
9 diamètres de Ø15 à Ø32;  
Il se fixe à vis M6 normal ou à pistolet;  
Insèrent dans guides 20 x 10, 25 x 7,5 et 27 x 18.



# Fixação

Fijación / Fixing / Fixation



243  
Abraçadeira Rectangular c/ Parafuso  
Abrazadera Rectangular c/ Tornillo  
Rectangular Pipe Clamp w/ Screw  
Collier Rectangulaire a/ Vis

AZ

Ref.		€/Un.	
0243.0105	80x40	0,57 €	25
0243.0106	100x50	0,60 €	25



AZ

244  
Abraçadeira Romex Gás  
Abrazadera Gas  
Gas Hose Clamp  
Collier de Serrage Gaz

Ref.		€/Un.	
0244.0101	3/8	0,46 €	100



AZ

242  
Abraçadeira c/ Parafuso Aço Zincado  
Abrazadera c/ Tirafondo Acero Galvanizado  
Galvanized Steel Pipe Clamp w/ Screw  
Collier Serrage a/ Vis Acier Galvanisé

Ref.		€/Un.	
0242.0103	1/2	0,25 €	50
0242.0104	3/4	0,27 €	50
0242.0105	1	0,29 €	50
0242.0106	1 1/4	0,31 €	50
0242.0107	1 1/2	0,35 €	50
0242.0108	2	0,38 €	50
0242.0109	2 1/2	0,42 €	50
0242.0110	3	0,47 €	50
0242.0111	4	0,53 €	50
0242.0113	5 (125)	0,54 €	50
0242.0114	6 (140)	1,15 €	50
0242.0115	7 (160)	1,40 €	50
0242.0116	8 (200)	1,65 €	25



Inox  
#304

242I  
Abraçadeira c/ Parafuso Inox  
Abrazadera c/ Tirafondo Inox  
S. S. Pipe Clamp w/ Screw  
Collier Serrage a/ Vis inox

Ref.		€/Un.	
0242.1103	1/2	1,40 €	50
0242.1104	3/4	1,46 €	50
0242.1105	1	1,49 €	50
0242.1106	1 1/4	1,60 €	50
0242.1107	1 1/2	1,69 €	50
0242.1108	2	1,80 €	50
0242.1109	2 1/2	2,00 €	50
0242.1110	3	2,20 €	50
0242.1111	4	2,40 €	50
0242.1113	5 (125)	2,51 €	50
0242.1114	6 (140)	2,80 €	50
0242.1115	7 (160)	3,20 €	50
0242.1118	8 (200)	4,00 €	50



AZ

248  
Abraçadeira c/ Fêmea M8 Aço Zincado  
Abrazadera c/ Tuerca M8 Acero Galvanizado  
Galvanized Steel Pipe Clamp w/ Nut M8  
Collier Serrage a/ Écrou M8 Acier Galvanisé

Ref.		€/Un.	
0248.0103	1/2	0,31 €	50
0248.0104	3/4	0,31 €	50
0248.0105	1	0,34 €	50
0248.0106	1 1/4	0,37 €	50
0248.0107	1 1/2	0,40 €	50
0248.0108	2	0,43 €	50
0248.0109	2 1/2	0,46 €	50
0248.0110	3	0,49 €	50
0248.0111	4	0,57 €	50
0248.0112	5 (125)	0,60 €	50
0248.0114	6 (140)	1,20 €	50
0248.0115	7 (160)	1,37 €	50
0248.0116	8 (200)	1,71 €	25



Inox  
#304

248I  
Abraçadeira c/ Fêmea M8 Inox  
Abrazadera c/ Tuerca M8 Inox  
S. S. Pipe Clamp w/ Nut M8  
Collier Serrage a/ Écrou M8 Inox

Ref.		€/Un.	
0248.1103	1/2	1,71 €	50
0248.1104	3/4	1,77 €	50
0248.1105	1	1,80 €	50
0248.1106	1 1/4	1,89 €	50
0248.1107	1 1/2	2,00 €	50
0248.1108	2	2,09 €	50
0248.1109	2 1/2	2,29 €	50
0248.1110	3	2,51 €	50
0248.1111	4	2,69 €	50
0248.1112	5 (125)	2,80 €	50
0248.1114	6 (140)	3,11 €	50
0248.1115	7 (160)	3,49 €	50
0248.1116	8 (200)	4,29 €	50



AZ

**246**  
**Abraçadeira Hércules Aço Zincado**  
 Abrazadera Hércules Acero Galvanizado  
 Galvanized Steel Hercules Hose Clamp  
 Collier Serrage Hercules Acier Galvanisé

Ref.		€/Un.	
0246.0104	3/4	<b>0,57 €</b>	50
0246.0105	1	<b>0,60 €</b>	50
0246.0106	1 1/4	<b>0,63 €</b>	50
0246.0107	1 1/2	<b>0,69 €</b>	50
0246.0108	2	<b>0,71 €</b>	50
0246.0109	2 1/2	<b>0,77 €</b>	50
0246.0110	3	<b>0,83 €</b>	50
0246.0111	3 1/2	<b>0,83 €</b>	50
0246.0112	4	<b>0,86 €</b>	50
0246.0113	5	<b>0,89 €</b>	50
0246.0114	6	<b>0,97 €</b>	50



AZ

**245**  
**Abraçadeira Romex Aço Zincado**  
 Abrazadera Tornillo Sin Fin Acero Galvanizado  
 Galvanized Steel Worm Gear Clamp  
 Collier de Serrage Sans Fin Acier Galvanisé

Ref.		€/Un.	
0245.0100	Nº0/A-3/16	<b>0,31 €</b>	100
0245.0101	Nº0/A-1/4	<b>0,31 €</b>	100
0245.0102	Nº1/A-3/8	<b>0,31 €</b>	100
0245.0103	Nº1-1/2	<b>0,31 €</b>	100
0245.0104	Nº2-3/4	<b>0,34 €</b>	100
0245.0105	Nº2,5-7/8	<b>0,37 €</b>	100
0245.0106	Nº3-1	<b>0,37 €</b>	100
0245.0107	Nº4-1 1/4	<b>0,40 €</b>	100
0245.0108	Nº4,5-1 1/2	<b>0,43 €</b>	50
0245.0109	Nº5-1 3/4	<b>0,46 €</b>	50
0245.0110	Nº5,5-2	<b>0,49 €</b>	50
0245.0111	Nº6-2 1/2	<b>0,49 €</b>	25
0245.0112	Nº7-3	<b>0,51 €</b>	25
0245.0113	Nº8-4	<b>0,54 €</b>	25



AZ

**249S**  
**Abraçadeira p/ Cobre Simples**  
 Abrazadera Simple c/ Tirafondo  
 Simple Pipe Clamp w/ Screw  
 Collier a/ Vis Simple

Ref.		€/Un.	
0249.1103	12	<b>0,28 €</b>	100
0249.1104	15	<b>0,30 €</b>	100
0249.1105	18	<b>0,31 €</b>	100
0249.1106	22	<b>0,37 €</b>	100
0249.1108	28	<b>0,41 €</b>	100



Inox #304

**246I**  
**Abraçadeira Hércules Inox**  
 Abrazadera Hércules Inox  
 S. S. Hercules Hose Clamp  
 Collier Serrage Hercules inox

Ref.		€/Un.	
0246.1104	3/4	<b>1,91 €</b>	50
0246.1105	1	<b>2,00 €</b>	50
0246.1106	1 1/4	<b>2,11 €</b>	50
0246.1107	1 1/2	<b>2,29 €</b>	50
0246.1108	2	<b>2,49 €</b>	50
0246.1109	2 1/2	<b>2,60 €</b>	50
0246.1110	3	<b>2,77 €</b>	50
0246.1111	3 1/2	<b>2,89 €</b>	50
0246.1112	4	<b>3,03 €</b>	50
0246.1113	5	<b>3,31 €</b>	50
0246.1114	6	<b>3,71 €</b>	50



Inox #304

**245I**  
**Abraçadeira Flex Inox**  
 Abrazadera Tornillo Sin Fin Inox  
 S. S. Worm Gear Clamp  
 Collier de Serrage Sans Fin inox

Ref.		€/Un.	
0245.0303	1/2 14-22	<b>1,17 €</b>	50
0245.0304	3/4 18-28	<b>1,23 €</b>	50
0245.0305	1 24-36	<b>1,31 €</b>	50
0245.0307	1 1/4 32-52	<b>1,37 €</b>	50
0245.0308	1 1/2 40-60	<b>1,46 €</b>	50
0245.0309	2 47-67	<b>1,54 €</b>	50
0245.0310	2 1/2 62-82	<b>1,60 €</b>	50
0245.0311	3 77-97	<b>1,60 €</b>	50
0245.0312	4 92-112	<b>1,74 €</b>	50
0245.0313	5 107-127	<b>1,89 €</b>	50
0245.0315	6 140-160	<b>2,31 €</b>	50



AZ

**249D**  
**Abraçadeira Parede Dupla**  
 Abrazadera Doble c/ Tirafondo  
 Double Pipe Clamp w/ Screw  
 Collier Double a/ Vis

Ref.		€/Un.	
0249.2103	12	<b>0,41 €</b>	50
0249.2104	15	<b>0,42 €</b>	50
0249.2105	18	<b>0,45 €</b>	50
0249.2106	22	<b>0,52 €</b>	50
0249.2107	28	<b>0,55 €</b>	50

# Fixação / Vedação

Fijación / Sellado | Fixing / Sealing | Fixation / Scellé



**248B**  
Abraçadeira c/ F M8 c/ Isolamento  
Abrazadera Isofónica M8  
Acoustic Insulation Clamp M8  
Isolation Acoustique Clamp M8

Ref.		€/Un.	
0248.0203	1/2	<b>0,65 €</b>	100
0248.0204	3/4	<b>0,69 €</b>	100
0248.0205	1	<b>0,79 €</b>	100
0248.0206	1 1/4	<b>0,85 €</b>	100
0248.0207	1 1/2	<b>0,88 €</b>	50
0248.0208	2	<b>1,05 €</b>	50
0248.0209	2 1/2	<b>1,25 €</b>	50
0248.0210	3	<b>1,38 €</b>	50
0248.0211	4	<b>1,73 €</b>	50



**250S**  
Abraçadeira Inox p/ Tubo  
Abrazadera Inox p/ Tubo  
S. S. Clamp f/ Pipe  
Collier Inox p/ Tuyau

Ref.		€/Un.	
0250.0104	15	<b>0,51 €</b>	90
0250.0106	18	<b>0,60 €</b>	60
0250.0107	22	<b>0,80 €</b>	40
0250.0108	28	<b>1,25 €</b>	20
0250.0109	35	<b>2,10 €</b>	10
0250.0110	42	<b>3,30 €</b>	7
0250.0111	54	<b>7,50 €</b>	5



**250D**  
Abraçadeira Inox Dupla p/ Tubo  
Abrazadera Inox Doble p/ Tubo  
S. S. Double Pipe Clamp  
Collier Inox Double p/ Tuyau

Ref.		€/Un.	
0250.0122	12	<b>1,15 €</b>	50
0250.0124	15	<b>1,51 €</b>	50
0250.0126	18	<b>1,55 €</b>	50
0250.0127	22	<b>1,70 €</b>	50



**249M**  
Abraçadeira Inox p/ Tubo Multicamada  
Abrazadera Inox p/ Tubo Inox Multicapa  
S. S. Clamp f/ Multilayer Pipe  
Collier Inox p/ Tuyau Multicouche

Ref.		€/Un.	
0250.0301	16	<b>0,49 €</b>	100
0250.0303	20	<b>0,71 €</b>	100
0250.0305	25	<b>0,91 €</b>	100
0250.0307	32	<b>1,20 €</b>	50



**249F**  
Fita Perfurada  
Cinta Perforada  
Perforated Tape  
Bande Perforée

Ref.		€/Un.	
0249.2001	12 (10 m)	<b>6,30 €</b>	10
0249.2002	17 (10 m)	<b>7,21 €</b>	10



**793S**  
Fita Teflon  
Cinta Teflón  
Teflon Tape  
Bande Teflon

Ref.		€/Un.	
0793.0111	12 m x 12 mm	<b>0,40 €</b>	100
0793.0112	50 m x 19 mm	<b>3,20 €</b>	100



**793G**  
Fita Teflon Gás  
Cinta Teflón Gas  
Gas Teflon Tape  
Bande Teflon Gaz

Ref.		€/Un.	
0793.0113	12 m x 12 mm	<b>1,15 €</b>	50



**793G**  
Fita Tapafugas  
Cinta Tapafugas  
Leakage Fixing Tape  
Bande Reparatteur de Tubes

Ref.		€/Un.	
0793.0125	2,5 m x 19 mm	<b>3,40 €</b>	24





793N  
Fita Teflon  
Cinta Teflón  
Teflon Tape  
Bande Teflon



790  
Massa Vedação XK  
Pasta Sellado XK  
Sealing Mass XK  
Masse Sceau XK

Ref.		€/Un.		
0793.0101	10 m x 12 mm	<b>0,35 €</b>	100	1000
0793.0102	40 m x 19 mm	<b>3,10 €</b>	50	200

Ref.		€/Un.		
0790.0221	50 g	<b>2,46 €</b>		50
0790.0222	250 g	<b>4,97 €</b>		36
0790.0223	500 g	<b>7,46 €</b>		24



242  
Cola PVC  
Cola PVC  
PVC Glue  
Colle PVC



200 g

794  
Linho  
Pasta de Cáñamo  
Linen  
Toile de Lin

Ref.		€/Un.		
0791.0101	0,25 Kg	<b>5,34 €</b>		50
0791.0104	0,5 Kg	<b>8,71 €</b>		50

Ref.		€/Un.		
0794.0101	12 x 12 mm	<b>9,43 €</b>		5 Kg



780B  
Vedação Borracha p/ Ligação  
Junta Goma p/ Latiguillo  
Flexible Hose Rubber Joint  
Joint Caoutchouc P/Tuyau



781T  
Vedação p/ Torneira  
Junta p/ Grifo  
Tap Joint  
Joint p/ Robinet

Ref.		€/Un.		
0780.0101	3/8	<b>0,04 €</b>		100
0780.0102	1/2	<b>0,04 €</b>		100
0780.0103	3/4	<b>0,05 €</b>		100
0780.0104	1	<b>0,10 €</b>		100

Ref.		€/Un.		
0781.0102	1/2	<b>0,04 €</b>		100
0781.0103	3/4	<b>0,05 €</b>		100
0781.0104	1	<b>0,06 €</b>		100



782C  
Vedação Cónica  
Junta Cónica  
Rubber Conic Joint  
Joint Conique



782F  
Vedação Fibra  
Junta Fibra  
Fiber Joint  
Joint Fibre

Ref.		€/Un.		
0782.0101	3/8	<b>0,04 €</b>		100
0782.0102	1/2	<b>0,05 €</b>		100

Ref.		€/Un.		
0782.0302	3/8	<b>0,04 €</b>		100
0782.0303	1/2	<b>0,04 €</b>		100
0782.0304	3/4	<b>0,05 €</b>		100
0782.0305	1	<b>0,05 €</b>		100
0782.0306	1 1/4	<b>0,10 €</b>		100
0782.0307	1 1/2	<b>0,14 €</b>		100
0782.0308	2	<b>0,23 €</b>		100



# Vedação / Isolamento

Sellado / Aislamento | Sealing / Insulation | Scellé / Isolation





783  
Vedação Válvula Poço  
Junta p/ Válvula de Fundo  
Joint f/ Foot Check Valve  
Joint p/ Clapet de Pied

Ref.		€/Un.	
0783.0104	1	0,65 €	10
0783.0105	11/4	0,98 €	10
0783.0106	11/2	1,29 €	10
0783.0107	2	1,63 €	10
0783.0108	21/2	3,18 €	5
0783.0109	3	4,83 €	5
0783.0110	4	5,75 €	5



783  
O-Ring  
O-Ring  
O-Ring  
O-Ring

Ref.		€/Un.	
0784.0102	3/8	4,00 €	100
0784.0103	1/2	5,00 €	100
0784.0104	3/4	0,06 €	100
0784.0105	1	0,09 €	100





784L  
O-Ring p/ Válvula Lavatório  
O-Ring p/ Válvula Lavabo  
O-Ring f/ Washbasin Waste  
O-Ring p/ Vanne Lavabo

Ref.	€/Un.	
0784.0201	0,27 €	10



786  
Vedação c/ Filtro  
Junta c/ Filtro  
Joint w/ Filter  
Joint a/ Filtre

Ref.		€/Un.	
0786.0503	1/2	0,63 €	100
0786.0504	3/4	0,63 €	100





945T  
Tubo Isolamento VIDOFLEX  
Tubo de Aislamiento  
Insulation Tube  
Tube d'Isolation

Ref.		€/m	
0945.0302	15 x 9	0,95 €	184
0945.0304	18 x 9	1,10 €	144
0945.0305	22 x 9	1,23 €	128
0945.0306	28 x 9	1,56 €	96
0945.0307	35 x 9	1,97 €	72
0945.0308	42 x 9	2,45 €	56
0945.0309	54 x 9	3,20 €	40





944  
Tubo Isolamento  
Tubo de Aislamiento  
Insulation Tube  
Tube d'Isolation

Ref.		€/m	
0944.0102	15 x 6	0,34 €	480
0944.0104	18 x 6	0,38 €	460
0944.0105	22 x 6	0,42 €	350
0944.0106	28 x 6	0,57 €	280
0945.0107	35 x 6	0,74 €	180
0945.0108	42 x 6	0,84 €	140



945F  
Fita Isolamento VIDOFLEX  
Cinta Aislante  
Insulation Tape  
Ruban Isolant

Ref.		€/m	
0945.0315	0,05 x 15 m	15,45 €	20

# 3

Gás  
Gas | Gas | Gaz



Pressão / Pressão Máxima | Presión / Presión Máxima  
Pressure / Maximum Pressure | Pression / Pression Maxime



Peso | Peso | Weight | Poids



Diâmetro Externo | Diámetro Externo  
Outer Diameter | Diamètre Intérieur



Diâmetro Interno | Diámetro Interno  
Inner Diameter | Diamètre Intérieur



Contacte-nos | Contáctenos | Contact us | Contactez-nous



Medida/Cor | Medida/Color  
Size/Colour | Mesure/Couleur



Cromado/Inox/Branco | Cromo/Inox/Blanco  
Chrome/S. S./White | Chrome/Inox/Blanc

# Válvulas Esfera p/ Gás

Válvulas Esfera p/ Gás | Gas Ball Valves | Vannes à Boisseau p/ Gaz



8307  
Válvula Esfera M/M  
Válvula Esfera M/M  
Ball Valve M/M  
Vanne à Boisseau M/M

Ref.		€/Un.	
0295.0103	1/2	3,56 €	24
0295.0104	3/4	5,00 €	20
0295.0105	1	6,30 €	10
0295.0106	1 1/4	12,00 €	6



8376  
Válvula Esfera Borboleta M/M  
Válvula Esfera Mariposa M/M  
Butterfly Ball Valve M/M  
Vanne à Boisseau Pampillon M/M

Ref.		€/Un.	
0295.0203	1/2	3,56 €	30
0295.0204	3/4	5,00 €	20
0295.0205	1	6,30 €	12
0295.0206	1 1/4	12,00 €	8



477  
Válvula Esfera M/F  
Válvula Esfera M/H  
Ball Valve M/F  
Vanne à Boisseau M/F

Ref.		€/Un.	
0295.0303	1/2	6,25 €	20
0295.0304	3/4	8,50 €	12
0295.0305	1	12,00 €	6
0295.0306	1 1/4	30,20 €	4



478  
Válvula Esfera Borboleta M/F  
Válvula Esfera Mariposa M/H  
Butterfly Ball Valve M/F  
Vanne à Boisseau Pampillon M/F

Ref.		€/Un.	
0295.0403	1/2	6,25 €	20
0295.0404	3/4	8,50 €	12
0295.0405	1	12,00 €	6



8305  
Válvula Esfera c/ Base M/M  
Válvula Esfera c/Patas M/M  
Ball Valve with Legs M/M  
Vanne à Boisseau a/Fixation M/M

Ref.		€/Un.	
0295.0503	1/2	6,00 €	20
0295.0504	3/4	8,00 €	14



8374  
Válvula Esfera c/ Base Borboleta M/M  
Válvula Esfera c/Patas Mariposa M/M  
Butterfly Ball Valve with Legs M/M  
Vanne à Boisseau a/Fixation Pampillon M/M

Ref.		€/Un.	
0295.0603	1/2	6,00 €	24
0295.0604	3/4	8,00 €	16

# Válvulas Esfera p/ Gás

Válvulas Esfera p/ Gás | Gas Ball Valves | Vannes à Boisseau p/ Gaz





475  
Válvula Esfera F/F  
Válvula Esfera H/H  
Ball Valve F/F  
Vanne à Boisseau F/F

Ref.		€/Un.	
0295.0703	1/2	<b>5,75 €</b>	20
0295.0704	3/4	<b>8,50 €</b>	14
0295.0705	1	<b>13,00 €</b>	6
0295.0706	1 1/4	<b>22,00 €</b>	4
0295.0707	1 1/2	<b>31,00 €</b>	2
0295.0708	2	<b>47,00 €</b>	1





476  
Válvula Esfera Borboleta F/F  
Válvula Esfera Mariposa H/H  
Butterfly Ball Valve F/F  
Vanne à Boisseau Pampillon F/F

Ref.		€/Un.	
0295.0803	1/2	<b>5,75 €</b>	24
0295.0804	3/4	<b>8,50 €</b>	14
0295.0805	1	<b>13,00 €</b>	6





8309  
Válvula Esfera p/ Contador Recta  
Válvula Esfera Recta p/ Contador  
Straight Ball Valve f/ Gas Meter  
Vanne à Boisseau Droit p/ Compteur de Gaz

Ref.		€/Un.	
0295.1204	3/4	<b>7,00 €</b>	14
0295.1206	1 1/4	<b>18,00 €</b>	5





8378  
V. Esfera p/ Cont. Recta Man. Borboleta  
Válvula Esfera Recta p/ Contador  
Straight Ball Valve f/ Gas Meter  
Vanne à Boisseau Droit p/ Compteur de Gaz

Ref.		€/Un.	
0295.1304	3/4	<b>8,00 €</b>	16
0295.1306	1 1/4	<b>18,00 €</b>	6





8308  
Válvula Esfera p/ Contador Esquadria  
Válvula Esfera p/ Contador Escuadra  
Angle Ball Valve f/ Gas Meter  
Vanne à Boisseau Angled p/ Compteur de Gaz

Ref.		€/Un.	
0295.1406	1 1/4	<b>16,00 €</b>	4



8377  
Válv. Esfera p/ Contador Esq. Borboleta  
Válvula Esfera p/ Contador Escuadra  
Butterfly Angle Ball Valve  
V. à Boisseau Angled p/ Compteur de Gaz

Ref.		€/Un.	
0295.1506	1 1/4	<b>16,00 €</b>	5



# Válvulas e Pateres Gás

Válvulas y Pateres Gas | Valves and Paters Gas | Vannes et Pateres Gaz



8651  
Válvula Esquentador GP  
Válvula Calentador GP  
Heator Valve GP  
Vanne p/ Chauffage GP

Ref.		€/Un.	
0295.2501	20x1,5	6,88 €	1



8652  
Válvula Esquentador GN  
Válvula Fogón GN  
Burner Valve GN  
Vanne p/Brûleur GN

Ref.		€/Un.	
0295.2521	3/4	8,98 €	1



8653  
Válvula Fogão GN  
Válvula Calentador GN  
Heater Valve GN  
Vanne p/ Chauffage GN

Ref.		€/Un.	
0295.2511		24,00 €	1



8238  
Válvula Corte c/ Mola  
Válvula Corte c/Muelle  
Ball Valve w/Spring  
Vanne à Boisseau w/Ressort

Ref.		€/Un.	
0295.1003	1/2	6,50 €	1
0295.1004	3/4	8,31 €	1
0295.1005	20x1,5	3,88 €	1



8565  
Pater Fogão Passagem GN  
Pater Fogón GN Continuo  
Burner Pater Pass Through GN  
Pater Brûler Continue GN

Ref.		€/Un.	
0295.2531	15x12	5,50 €	8
0295.2532	22x15	5,50 €	8



8568  
Pater Fogão Terminal GN  
Pater Fogón GN Terminal  
Burner Pater End GN  
Pater Brûler Terminal GN

Ref.		€/Un.	
0295.2541	15x12	5,50 €	8
0295.2542	18x15	5,50 €	8



8563  
Pater Esquentador Passagem GP  
Pater Calentador GP Continua  
Heater Pater Pass Through GP  
Pater Chauffage Continue GP

Ref.		€/Un.	
0295.2551	12	2,85 €	15
0295.2552	15	2,85 €	15



8566  
Pater Esquentador Terminal GP  
Pater Calentador Terminal GP  
Heater Pater End GP  
Pater Chauffage Terminal GP

Ref.		€/Un.	
0295.2561	12	2,85 €	15
0295.2562	15	2,85 €	15
0295.2563	18	2,85 €	15
0295.2564	22	2,85 €	15



8564  
Pater Esquentador Passagem GN  
Pater Calentador GN Continua  
Heater Pater Pass Through GN  
Pater Chauffage Continue GN

Ref.		€/Un.	
0295.2574	22	2,85 €	10



8567  
Pater Esquentador Terminal GN  
Pater Calentador Terminal GN  
Heater Pater End GN  
Pater Chauffage Terminal GN



Ref.		€/Un.	
0295.2584	22	2,85 €	10

# Kits Válvulas e Pateres Gás

Kits Válvulas y Pateres Gas | Kits Valves and Paters Gas | Kits Vannes et Pateres Gaz





Kit GN1  
8562 + 8567

Ref.		€/Un.	
0295.5304	22	11,83 €	10





Kit GN2  
8652 + 8564

Ref.		€/Un.	
0295.5204	22	11,83 €	10





Kit GN3  
8653 + 8565

Ref.		€/Un.	
0295.5402	15-12	29,00 €	10
0295.5404	22-15	29,00 €	10





Kit GN4  
8653 + 8568

Ref.		€/Un.	
0295.5502	15-12	29,00 €	10
0295.5503	18-15	29,00 €	10





Kit GP1  
8651 + 8566

Ref.		€/Un.	
0295.5001	12	9,70 €	10
0295.5002	15	9,70 €	10
0295.5003	18	9,70 €	10
0295.5004	22	9,70 €	10



Kit GP2  
8651 + 8563

Ref.		€/Un.	
0295.5101	12	9,70 €	10
0295.5102	15	9,70 €	10



# Ligações Inox Revestidas p/ Gás

Conexiones Flexibles Revestidas Inox p/ Gas | S. S. Flexible Coated Gas Hoses | Inox Coated Tuyaux Flexibles p/ Gaz

## UNE 60713

## Branco

Blanco / White / Blanc



1 - Latão | 2 - Inox | 3 - Inox | 4 - Amarelo/Branco | 5 - Borracha  
 1 - Laton | 2 - Inox | 3 - Inox | 4 - Amarillo/Blanco | 5 - Goma  
 1 - Brass | 2 - S. S. | 3 - S. S. | 4 - Yellow/White | 5 - Rubber  
 1 - Laiton | 2 - Inox | 3 - Inox | 4 - Jaune/Blanc | 5 - Caoutchouc



0,4 bar



F/F 1/2x1/2 - ØDN12 H/H 1/2x1/2 - ØDN12

Ref.		€/Un.		
A101.0306	100x170	<b>7,49 €</b>	2	10
A101.0305	150x255	<b>8,36 €</b>	2	10
A101.0307	200x340	<b>8,03 €</b>	2	10
A101.0308	300x510	<b>8,88 €</b>	2	10
A101.0309	500x850	<b>11,34 €</b>	2	10
A101.0310	750x1275	<b>14,45 €</b>	2	10
A101.0311	1000x1700	<b>19,26 €</b>	2	10

M/F 1/2x1/2 - ØDN12 M/H 1/2x1/2 - ØDN12

Ref.		€/Un.		
A105.3056	100x170	<b>7,94 €</b>	2	10
A105.3055	150x255	<b>8,60 €</b>	2	10
A105.3057	200x340	<b>9,18 €</b>	2	10
A105.3058	300x510	<b>10,10 €</b>	2	10
A105.3059	500x850	<b>13,46 €</b>	2	10
A105.3060	750x1275	<b>17,46 €</b>	2	10
A105.3061	1000x1700	<b>21,20 €</b>	2	10

F/F 1/2x3/4 - ØDN12 H/H 1/2x3/4 - ØDN12

Ref.		€/Un.		
A101.0406	100x170	<b>8,99 €</b>	2	10
A101.0405	150x255	<b>9,95 €</b>	2	10
A101.0407	200x340	<b>10,40 €</b>	2	10
A101.0408	300x510	<b>11,32 €</b>	2	10
A101.0409	500x850	<b>14,30 €</b>	2	10
A101.0410	750x1275	<b>18,02 €</b>	2	10
A101.0411	1000x1700	<b>23,32 €</b>	2	10

M/F 1/2x3/4 - ØDN12 M/H 1/2x3/4 - ØDN12

Ref.		€/Un.		
A105.4056	100x170	<b>9,38 €</b>	2	10
A105.4055	150x255	<b>10,50 €</b>	2	10
A105.4057	200x340	<b>11,78 €</b>	2	10
A105.4058	300x510	<b>12,54 €</b>	2	10
A105.4059	500x850	<b>16,28 €</b>	2	10
A105.4060	750x1275	<b>21,68 €</b>	2	10
A105.4061	1000x1700	<b>23,32 €</b>	2	10

F/F 3/4x3/4 - ØDN20 H/H 3/4x3/4 - ØDN20

Ref.		€/Un.		
A101.0506	100x170	<b>11,22 €</b>	2	10
A101.0505	150x255	<b>11,74 €</b>	2	10
A101.0507	200x340	<b>11,96 €</b>	2	10
A101.0508	300x510	<b>12,78 €</b>	2	10
A101.0509	500x850	<b>16,42 €</b>	2	10
A101.0510	750x1275	<b>20,28 €</b>	2	10
A101.0511	1000x1700	<b>23,92 €</b>	2	10

M/F 3/4x3/4 - ØDN20 M/H 3/4x3/4 - ØDN20

Ref.		€/Un.		
A105.5055	100x170	<b>11,84 €</b>	2	10
A105.5056	150x255	<b>11,94 €</b>	2	10
A105.5057	200x340	<b>12,04 €</b>	2	10
A105.5058	300x510	<b>12,86 €</b>	2	10
A105.5059	500x850	<b>16,98 €</b>	2	10
A105.5060	750x1275	<b>21,12 €</b>	2	10
A105.5061	1000x1700	<b>24,78 €</b>	2	10

# Ligações Inox Revestidas p/ Gás

Conexiones Flexibles Revestidas Inox p/ Gas | S. S. Flexible Coated Gas Hoses | Inox Coated Tuyaux Flexibles p/ Gaz

## UNE 60713

## Amarelo

Amarillo / Yellow / Jaune

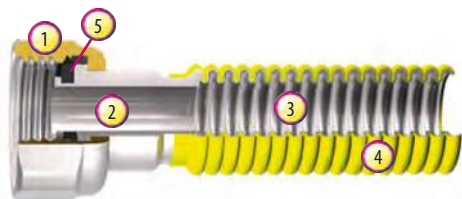

1 - Latão | 2 - Inox | 3 - Inox | 4 - Amarelo/Branco | 5 - Borracha  
 1 - Laton | 2 - Inox | 3 - Inox | 4 - Amarillo/Blanco | 5 - Goma  
 1 - Brass | 2 - S. S. | 3 - S. S. | 4 - Yellow/White | 5 - Rubber  
 1 - Laiton | 2 - Inox | 3 - Inox | 4 - Jaune/Blanc | 5 - Caoutchouc



0,4 bar



F/F 1/2x1/2 - ØDN12 H/H 1/2x1/2 - ØDN12

Ref.		€/Un.		
A105.0306	100x170	<b>7,94 €</b>	2	10
A105.0305	150x255	<b>8,36 €</b>	2	10
A105.0307	200x340	<b>8,52 €</b>	2	10
A105.0308	300x510	<b>9,38 €</b>	2	10
A105.0309	500x850	<b>12,12 €</b>	2	10
A105.0310	750x1275	<b>15,30 €</b>	2	10
A105.0311	1000x1700	<b>18,76 €</b>	2	10

M/F 1/2x1/2 - ØDN12 M/H 1/2x1/2 - ØDN12

Ref.		€/Un.		
A105.3005	100x170	<b>7,94 €</b>	2	10
A105.3006	150x255	<b>8,60 €</b>	2	10
A105.3007	200x340	<b>9,18 €</b>	2	10
A105.3008	300x510	<b>10,10 €</b>	2	10
A105.3009	500x850	<b>13,46 €</b>	2	10
A105.3010	750x1275	<b>17,46 €</b>	2	10
A105.3011	1000x1700	<b>21,20 €</b>	2	10

F/F 1/2x3/4 - ØDN12 H/H 1/2x3/4 - ØDN12

Ref.		€/Un.		
A105.0406	100x170	<b>8,56 €</b>	2	10
A105.0405	150x255	<b>9,95 €</b>	2	10
A105.0407	200x340	<b>10,40 €</b>	2	10
A105.0408	300x510	<b>11,32 €</b>	2	10
A105.0409	500x850	<b>14,30 €</b>	2	10
A105.0410	750x1275	<b>18,02 €</b>	2	10
A105.0411	1000x1700	<b>23,32 €</b>	2	10

M/F 1/2x3/4 - ØDN12 M/H 1/2x3/4 - ØDN12

Ref.		€/Un.		
A105.4006	100x170	<b>8,88 €</b>	2	10
A105.4005	150x255	<b>10,50 €</b>	2	10
A105.4007	200x340	<b>11,78 €</b>	2	10
A105.4008	300x510	<b>12,54 €</b>	2	10
A105.4009	500x850	<b>16,28 €</b>	2	10
A105.4010	750x1275	<b>21,68 €</b>	2	10
A105.4011	1000x1700	<b>23,32 €</b>	2	10

F/F 3/4x3/4 - ØDN20 H/H 3/4x3/4 - ØDN20

Ref.		€/Un.		
A105.0506	100x170	<b>11,22 €</b>	2	10
A105.0505	150x255	<b>11,74 €</b>	2	10
A105.0507	200x340	<b>11,96 €</b>	2	10
A105.0508	300x510	<b>12,78 €</b>	2	10
A105.0509	500x850	<b>16,42 €</b>	2	10
A105.0510	750x1275	<b>20,28 €</b>	2	10
A105.0511	1000x1700	<b>23,92 €</b>	2	10

M/F 3/4x3/4 - ØDN20 M/H 3/4x3/4 - ØDN20

Ref.		€/Un.		
A105.5005	100x170	<b>11,84 €</b>	2	10
A105.5006	150x255	<b>11,94 €</b>	2	10
A105.5007	200x340	<b>12,04 €</b>	2	10
A105.5008	300x510	<b>12,86 €</b>	2	10
A105.5009	500x850	<b>16,98 €</b>	2	10
A105.5010	750x1275	<b>21,12 €</b>	2	10
A105.5011	1000x1700	<b>24,78 €</b>	2	10



## UNE 60713



- 1 Latão | Latón | Brass | Laiton
- 2 Inox | Inox | S.S. | Inox
- 3 Borracha Reforçada | Caucho Reforzado | Reinforced Rubber | Caoutchouc Renforcé

F1/4NPT x20x1,5  
H1/4NPT x20x1,5  
F1/4NPT x20x1,5  
F1/4NPT x20x1,5

Ref.		€/Un.		
A108.0250	50 cm	<b>7,28 €</b>	1	10
A108.0260	60 cm	<b>7,87 €</b>	1	10
A108.0280	80 cm	<b>8,74 €</b>	1	10
A108.0300	100 cm	<b>10,84 €</b>	1	10
A108.0320	120 cm	<b>12,04 €</b>	1	10
A108.0340	140 cm	<b>13,44 €</b>	1	10

F/F NPT 1/4" NPT  
H/H NPT 1/4" NPT  
F/F NPT 1/4" NPT  
F/F NPT 1/4" NPT

Ref.		€/Un.		
A108.0150	50 cm	<b>7,28 €</b>	1	10
A108.0160	60 cm	<b>7,87 €</b>	1	10
A108.0180	80 cm	<b>8,74 €</b>	1	10
A108.0120	100 cm	<b>10,84 €</b>	1	10
A108.0130	120 cm	<b>12,04 €</b>	1	10
A108.0140	140 cm	<b>13,44 €</b>	1	10

Esmerilada F1/4NPT x20x1,5  
Esmerilada H1/4NPT x20x1,5  
Frosted F1/4NPT x20x1,5  
Givré F1/4NPT x20x1,5

Ref.		€/Un.		
A108.0450	50cm	<b>7,55 €</b>	1	10
A108.0460	60cm	<b>8,36 €</b>	1	10
A108.0480	80cm	<b>9,69 €</b>	1	10
A108.0500	100cm	<b>11,27 €</b>	1	10

Esmerilada F/F NPT 1/4" NPT  
Escarchado H/H NPT 1/4" NPT  
Frosted F/F NPT 1/4" NPT  
Givré F/F NPT 1/4" NPT

Ref.		€/Un.		
A108.0650	50 cm	<b>7,55 €</b>	1	10
A108.0660	60 cm	<b>8,36 €</b>	1	10
A108.0680	80 cm	<b>9,69 €</b>	1	10
A108.0700	100 cm	<b>10,51 €</b>	1	10

## Heliflex

Tubos e Mangueiras, S.A.



819PC  
Tubo Heligás Propano  
Tubo Heligás Propano  
Heligás Protane Hose  
Heligás Tuyau de Propane

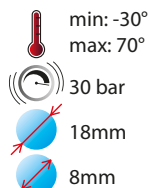

Ref.		€/m	
0819.0112	8 mm	<b>6,25 €</b>	25 m



819B  
Tubo Heligás Butano  
Tubo Heligás Butano  
Heligás Butane Hose  
Heligás Tuyau de Butane



Ref.		€/m	
0819.0101	8 mm	<b>2,00 €</b>	30 m

# Vedações Gás

Juntas Gas | Gas Washers | Joints Gaz



793G  
Fita Teflon Gás  
Cinta de Teflón Gas  
Teflon Tape Gas  
Ruban Teflon Gaz



Ref.		€/Un.	
0793.0113	12 mm x 12 m	1,15 €	10



A106I  
Vedação p/ Ligação Inox  
Junta p/ Conexión Inox  
Washer f/ S. S. Gas Hose  
Joint p/ Flexible p/ Gas

Ref.		€/Un.	
A106.0103	1/2	0,11 €	10
A106.0104	3/4	0,12 €	10



A106N  
Junta Ligação NEOPRÉNO  
Junta NEOPRÉNO  
NEOPRÉNO Washer  
Joint NEOPRÉNO

Ref.		€/Un.	
A106.0504	1/2 - 18x12x2	0,11 €	10
A106.0505	3/4 - 24x18x2	0,13 €	10
A106.0506	1 - 30x24x2,5	0,19 €	10
A106.0507	1 1/4 - 39x30x2,5	0,25 €	10



A106A  
Vedação Alumínio  
Junta Alumínio  
Aluminium Washer  
Joint Alluminium

Ref.		€/Un.	
A106.0203	1/2	0,11 €	10
A106.0204	3/4	0,15 €	10

# Redutores Gás

Reductores Gas | Gas Regulators | Régulateurs Gaz



A121BP  
Redutor Gás Baixa Pressão NBR  
Reductor Gas Baja Presión NBR  
Low Pressure Gas Regulator NBR  
Régulateur de Gaz Basse Pression NBR

Ref.		€/Un.	
A121.0760	F/F 1/4x1/2	20,51 €	1

10 Kg /h 37 mbar



A121RB  
Redutor Gás Baixa Pressão NBR  
Reductor Gas Baja Presión NBR  
Low Pressure Gas Regulator NBR  
Régulateur de Gaz Basse Pression NBR

Ref.		€/Un.	
A121.0755	F/F 1/4	11,54 €	1

4 Kg/h 37 mbar



A121AP  
Redutor Gás Alta pressão  
Reductor Gas Alta Presión  
High Pressure Gas Regulator  
Régulateur de Gaz Haute Pression

Ref.		€/Un.	
A121.0750	F/F 1/4	17,00 €	1

12 Kg /h 1'5 Bar



A121RM  
Redutor Alta Pressão c/ Manómetro  
Reductor Gas c/ Manómetro  
Gas Regulator w/ Pressure Gauge  
Régulateur de Gaz a/ Manomètre

Ref.		€/Un.	
A121.0504		24,06 €	1

12 Kg/h



A121LA  
Limitador Alta Pressão  
Limitador Alta Presión  
High Pressure Militer  
Limiteur de Haute Pression

Ref.		€/Un.	
A121.2001	M/F 20x1,5	20,11 €	1

10 Kg /h



A121IA  
Inversor Automático c/ Visor  
Inversor Automático c/ Visor  
Automatic Inverter w/ Display  
Inverseur Automatique a/ Visueur

Ref.		€/Un.	
A121.0602	M/M 20x1,5	58,94 €	1

8/10 Kg/h

# Acessórios Gás

Accesorios Gas | Gas Accessories | Accessoires Gaz



295.300  
Casquilha Duplo M/M Rosca NPT  
Machón NPT  
Nipple NPT  
Mamelon Egal NPT

Ref.		€/Un.	
0295.3001	1/4	0,74 €	10
0295.3002	14x3/8	2,29 €	10
0295.3003	3/8	2,29 €	10
0295.3004	1/2	3,03 €	10
0295.3005	3/4x1/4	4,14 €	10
0295.3006	3/4	6,00 €	10
0295.3007	1	9,94 €	10



295.301  
Casquilha Duplo M/M NPT/ISO  
Machón NPT/ISO  
Nipple NPT/ISO  
Mamelon Egal NPT/ISO

Ref.		€/Un.	
0295.3011	20-1,5x1/4	1,25 €	10
0295.3012	20-1,5x3/8	1,44 €	10
0295.3013	20-1,5x1/2	2,57 €	10
0295.3014	20-1,5x3/4	3,89 €	10
0295.3015	24-1,5x1/4	2,80 €	10
0295.3017	24-1,5x1/2	2,90 €	10
0295.3020	27-1,5x1/4	3,37 €	5
0295.3021	27-1,5x3/8	3,26 €	5
0295.3022	27-1,5x1/2	3,29 €	5
0295.3023	27-1,5x3/4	3,42 €	5



295.303  
Casquilha Duplo M/M Rosca  
Machón  
Nipple  
Mamelon Egal

Ref.		€/Un.	
0295.3031	1/2x1/4 NPT	1,25 €	10
0295.3035	1/2x1/2	3,03 €	10



295.306  
Casquilha M/F  
Unión M/H  
Coupling M/F  
Jonction M/F

Ref.		€/Un.	
0295.3061	1/4 NPT x 1/4	1,80 €	10
0295.3062	1/2x1/4 NPT	1,97 €	10
0295.3063	1/2x20-1,5	2,43 €	10
0295.3065	7/8x1/4	3,63 €	5



295.307  
Casquilha F/F  
Unión H/H  
Socket F/F  
Manchon F/F

Ref.		€/Un.	
0295.3071	1/2x1/4	2,40 €	10
0295.3072	20x1,5x12	2,43 €	10
0295.3073	1/2x7/8	2,57 €	10



295.305  
Casquilha Triplíco NPT  
Unión Triple NPT  
Triple Cowpling NPT  
Jonction Triple NPT

Ref.		€/Un.	
0295.3052	1/4 NPT	5,40 €	2



295.304  
Casquilha Sextavado Interior  
Unión c/ Hexágono Interior  
Coupling w/ Hexagon  
Jonction a/ Hexagone Interieur

Ref.		€/Un.	
0295.3041	20x1,5	1,89 €	10



295.308  
Casquilha Soldar/Roscar  
Unión Soldar/Rosca  
Coupling Soldering/Thread  
Jonction à Souder-Visser

Ref.		€/Un.	
0295.3081	10	1,80 €	10
0295.3082	12	1,80 €	10
0295.3083	15	1,86 €	10
0295.3084	18	2,74 €	10



295.309  
Casquilha Soldar/Roscar  
Unión Soldar/Rosca  
Coupling Soldering/Thread  
Jonction à Souder-Visser

Ref.		€/Un.	
0295.3095	1/2x12	1,89 €	10
0295.3096	1/2x15	1,97 €	10
0295.3097	1/2x18	2,83 €	10
0295.3098	1/2x22	3,03 €	10



295.356  
Casquilha Esfero/Cónico  
Unión Esfera/Cónica  
Espherical/Conical Coupling  
Jonction Sphère/Conique

Ref.		€/Un.	
0295.3565	3/4x18	3,54 €	10
0295.3566	3/4x22	3,54 €	10

# Acessórios Gás

Accesórios Gas | Gas Accessories | Accessoires Gaz



**295.310**  
Toma de Pressão Petterson  
Toma de Presión Petterson  
Pressure Plug Petterson  
Raccor Pression Petterson

Ref.		€/Un.	
0295.3101	1/4 NPT	<b>2,15 €</b>	10



**295.318**  
Terminal Soldar p/ Porca  
Terminal Soldar  
Welding Fitting  
Raccord à Souder

Ref.		€/Un.	
0295.3181	8	<b>0,77 €</b>	10
0295.3182	10	<b>0,57 €</b>	10
0295.3183	12	<b>0,57 €</b>	10
0295.3184	15	<b>0,63 €</b>	10
0295.3185	18	<b>1,60 €</b>	10
0295.3186	22	<b>2,00 €</b>	10



**295.314**  
Terminal Lira  
Terminal Lira  
Fitting f/ Gas Hose  
Raccord p/ Lyre

Ref.		€/Un.	
0295.3141	1/4NPT	<b>0,87 €</b>	10
0295.3142	1/4 NPT - 3/4	<b>2,57 €</b>	10
0295.3143	1-11/4	<b>8,23 €</b>	5



**295.315**  
Terminal Lira Junta Esférica  
Terminal Lira Junta Esférica  
Fitting f/ Gas Hose Spherical Joint  
Raccord p/ Lyre a/ Sphère Joint

Ref.		€/Un.	
0295.3151	1/4 NPT	<b>1,51 €</b>	10



**295.313**  
Terminal Repsol Pol Cónico  
Terminal Repsol Pol Cónico  
Pol Fitting Conical  
Raccor Pol Conique

Ref.		€/Un.	
0295.3131	1/4	<b>2,97 €</b>	10



**295.319**  
Terminal Soldar p/ Porca 3/4  
Terminal Soldar 3/4"  
Welding Fitting 3/4"  
Raccord à Souder 3/4"

Ref.		€/Un.	
0295.3193	12	<b>1,46 €</b>	10
0295.3194	15	<b>1,46 €</b>	10
0295.3195	18	<b>1,34 €</b>	10
0295.3196	22	<b>4,10 €</b>	10



**295.320**  
Terminal p/ Petterson p/ Porca 1 1/4  
terminal Petterson Tuerca 11/4"  
Pettersen and Fitting Nut 11/4"  
Terminal Petterson Écrou 11/4"

Ref.		€/Un.	
0295.3206	22	<b>6,86 €</b>	5
0295.3207	28	<b>6,86 €</b>	5



**295.321**  
Terminal Soldar Esférico-Cónico  
Terminal Soldar Esférico/Cónico  
Sphérical/Conical Welding Fitting  
Raccord à Souder Sphère/Conique

Ref.		€/Un.	
0295.3215	18	<b>0,70 €</b>	10



**295.323**  
Terminal Abocardado c/ Porca  
Racor 2P Recto  
Connector 2P Straight  
Raccord 2P à Souder-Visser

Ref.		€/Un.	
0295.3231	10x3/8	<b>1,06 €</b>	25
0295.3232	10x1/2	<b>1,30 €</b>	25
0295.3233	12x3/8	<b>1,07 €</b>	25
0295.3234	12x1/2	<b>1,03 €</b>	25
0295.3235	12x3/4	<b>2,59 €</b>	25
0295.3236	12x7/8	<b>2,40 €</b>	25
0295.3237	12x20-1,5	<b>1,59 €</b>	25
0295.3239	14x1/2	<b>1,12 €</b>	25
0295.3241	15x3/8	<b>1,14 €</b>	25
0295.3242	15x1/2	<b>0,97 €</b>	25
0295.3243	15x3/4	<b>1,66 €</b>	25
0295.3244	15x7/8	<b>2,70 €</b>	25
0295.3245	15x20-1,5	<b>1,55 €</b>	25
0295.3246	18x1/2	<b>1,35 €</b>	25
0295.3247	18x3/4	<b>1,58 €</b>	25
0295.3248	18x1	<b>2,78 €</b>	25
0295.3249	18x7/8	<b>2,74 €</b>	25
0295.3250	10x20-1,5	<b>1,81 €</b>	25
0295.3251	22x1/2	<b>2,53 €</b>	25
0295.3252	22x3/4	<b>1,81 €</b>	25
0295.3253	22x1	<b>2,65 €</b>	25
0295.3254	22x7/8	<b>2,68 €</b>	25
0295.3255	22x20-1,5	<b>2,99 €</b>	25
0295.3256	22x11/4	<b>5,58 €</b>	25
0295.3257	28x3/4	<b>3,57 €</b>	25
0295.3258	28x1	<b>3,06 €</b>	25
0295.3259	28x7/8	<b>3,26 €</b>	25
0295.3260	28x11/4	<b>5,08 €</b>	10
0295.3261	35x11/4	<b>5,69 €</b>	10
0295.3262	35x11/2	<b>7,35 €</b>	10
0295.3264	42x2	<b>14,87 €</b>	5
0295.3265	54x2	<b>14,69 €</b>	5



# Acessórios Gás

Accesórios Gas | Gas Accessories | Accessoires Gaz



295.330  
Terminal Abocardado Curvo c/ Porca  
Racor 2P Curvo  
Bend 2 Pieces  
Conde 2P à Sonder-Visser

Ref.		€/Un.	
0295.3301	10x3/8	2,13 €	25
0295.3304	12x1/2	1,62 €	25
0295.3305	12x20-1,5	2,55 €	25
0295.3311	15x1/2	1,57 €	25
0295.3312	15x3/4	2,59 €	25
0295.3314	15x20-1,5	2,47 €	25
0295.3319	18x1/2	1,93 €	25
0295.3320	18x3/4	2,53 €	25
0295.3321	18x1	3,40 €	25
0295.3322	18x7/8	4,54 €	25
0295.3323	10x20-1,5	2,72 €	25
0295.3325	22x3/4	5,51 €	25
0295.3326	22x1	3,99 €	25
0295.3327	22x7/8	4,24 €	25



295.333  
Terminal Soldar Esfero/Cónico c/ Porca  
Terminal Soldar c/ Tuerca  
Welding Fitting w/ Nut  
Raccord à Souder a/ Écrou

Ref.		€/Un.	
0295.3331	18x3/4	7,23 €	10
0295.3332	22x3/4	7,66 €	10
0295.3333	28x3/4	9,24 €	10



295.334  
Porta Borracha p/ Porca  
Portagoma p/ Tuerca  
Gas Hose Fitting f/ Nut  
Tétine p/ Écrou

Ref.		€/Un.	
0295.3341	5STD-GPL	0,74 €	10
0295.3342	5STD-GN	2,60 €	10
0295.3343	3/4	2,03 €	10



295.335  
Porta Borracha Macho NPT  
Porta Goma Macho NPT  
Gas Hose Fitting Male NPT  
Tétine Mâle NPT

Ref.		€/Un.	
0295.3351	1/4	0,79 €	10
0295.3352	3/8	2,03 €	10



295.336  
Porta Borracha Rosca/Macho  
Porta Goma Macho  
Gas Hose Fitting Male  
Tétine Mâle

Ref.		€/Un.	
0295.3363	1/2 GPL	1,63 €	10
0295.3364	1/2 GN	3,11 €	10



292V  
União p/ Mangueira Gás  
Unión Porta Goma  
Gas Hose Union  
Tétine Double

Ref.	€/Un.	
0292.0101	1,09 €	10



295.337  
Porta Borracha Rosca/Fêmea NPT  
Porta Goma Hembra NPT  
Gas Hose Fitting Female NPT  
Tétine Femelle NPT

Ref.		€/Un.	
0295.3372	20-1,5 GPL	3,54 €	10
0295.3373	1/2 GN	3,54 €	10
0295.3374	1/2 GPL	3,34 €	10



295.338  
Porta Borracha p/ Soldar  
Porta Goma Soldar  
Welding Fitting f/ Gas Hose  
Tétine à Souder

Ref.		€/Un.	
0295.3382	10 GPL	0,63 €	10
0295.3383	12 GPL	0,63 €	10
0295.3384	15 GPL	0,87 €	10
0295.3385	18 GPL	1,89 €	10
0295.3386	22 GPL	2,91 €	10
0295.3387	15 GN	1,71 €	10
0295.3388	18 GN	2,31 €	10



292F  
Forquilha p/ Mangueira Gás  
Porta Goma Y  
Gas Hose Fitting Y  
Tétine 3 Voies Y

Ref.	€/Un.	
0292.0301	2,00 €	10



292T  
Tê p/ Mangueira Gás  
Te Porta Goma  
Tee f/ Gas Hose  
Tétine 3 Voies

Ref.	€/Un.	
0292.0201	2,00 €	10

# Acessórios Gás

Accesórios Gas | Gas Accessories | Accessoires Gaz



295.343  
Porca  
Tuerca  
Nut  
Écrou

Ref.		€/Un.	
0295.3431	20-1,5	0,71 €	10
0295.3432	24-1,5	1,60 €	10
0295.3433	27-1,5	1,89 €	10
0295.3434	30-1,5	2,43 €	10
0295.3435	1/2	0,71 €	10
0295.3437	1/2 17	0,71 €	10
0295.3440	20-1,5 17	0,71 €	10



295.348  
Porca Pol UNF Esq.  
Tuerca Pol  
Pol Nut  
Écrou Pol

Ref.		€/Un.	
0295.3486	7/8	2,60 €	5



295.349  
Porca Pol Repsol  
Tuerca Pol (Repsol)  
Pol Nut (Repsol)  
Écrou Pol (Repsol)

Ref.		€/Un.	
0295.3491		2,23 €	5



295.342  
Porca p/ Porta Borracha 3/4  
Tuerca p/Porta Goma  
Gas Hose Fitting Nut  
Écrou p/ Tétine

Ref.		€/Un.	
0295.3424	3/4	1,12 €	10



296.346  
Porca Cega  
Tuerca Ciega  
Blind Nut  
Écrou Aveugle

Ref.		€/Un.	
0295.3461	20-1,5	1,29 €	10
0295.3463	1/2	1,29 €	10
0295.3464	3/4	2,09 €	10
0295.3466	7/8	2,17 €	10



295.344  
Porca Dupla  
Tuerca Doble  
Double Nut  
Écrou Double

Ref.		€/Un.	
0295.3441	20-1,5	3,13 €	25
0295.3442	20-1,5x1/2	2,98 €	25
0295.3443	1/2x1/2	2,80 €	25



295.350  
Tampão p/ Soldar  
Tapón Soldar  
Soldering Cap  
Bouchon à Souder

Ref.		€/Un.	
0295.3501	8	0,24 €	10
0295.3502	10	0,26 €	10
0295.3503	12	0,26 €	10
0295.3504	15	0,50 €	10
0295.3505	18	0,54 €	10
0295.3506	22	0,54 €	10



295.347  
Porca c/ Contador  
Tuerca p/ Contador  
Nut f/ Gas Meter  
Écrou p/ Compteur de gas

Ref.		€/Un.	
0295.3471	7/8x23	1,87 €	10
0295.3472	7/8x25	1,97 €	10
0295.3473	11/4	4,14 €	5



295.351  
Tampão M Rosca  
Tapón M Rosca  
Threaded Plug  
Bouchon M à Visser

Ref.		€/Un.	
0295.3511	20-1,5	1,26 €	10
0295.3513	1/2	1,26 €	10
0295.3514	3/4	1,87 €	10
0295.3515	7/8	2,71 €	10
0295.3516	1	3,09 €	10



295.352  
Tampão M Selável  
Tapón M Precintable  
Lockable Plug  
Bouchon Refermable



Ref.		€/Un.	
0295.3521	20-1,5	1,03 €	10
0295.3523	1/2	1,11 €	10
0295.3524	3/4	2,34 €	10

# Acessórios Gás

Accesórios Gas | Gas Accessories | Accessoires Gaz





295.361  
União Soldar  
Manquito Soldar  
Welding Socket  
Manchon à Souder

Ref.		€/Un.	
0295.3612	12	0,94 €	10
0295.3613	15	1,29 €	10
0295.3614	18	1,24 €	10
0295.3615	22	2,80 €	10





295.357  
Joelho Soldar  
Codo Soldar  
Soldering Elbow  
Coude à Souder

Ref.		€/Un.	
0295.3572	10	2,37 €	10
0295.3573	12	2,11 €	10
0295.3574	15	2,71 €	10
0295.3575	18	3,20 €	10
0295.3576	22	6,06 €	5





295.358  
Joelho M/F  
Codo M/H  
Elbow M/F  
Coude M/F

Ref.		€/Un.	
0295.3581	1/4	2,94 €	10



295.362  
Tê Simples Soldar  
Te Soldar  
Welding Tee  
Té à Souder

Ref.		€/Un.	
0295.3621	8	2,31 €	10
0295.3622	10	2,31 €	10
0295.3623	12	2,31 €	10
0295.3624	15	3,54 €	10
0295.3625	18	5,00 €	10
0295.3626	22	6,46 €	5
0295.3627	28	10,26 €	5



295.365  
Tê Roscar F  
Te H  
Tee F  
Té F

Ref.		€/Un.	
0295.3651	12x1/2x1/4	4,45 €	10
0295.3652	1/4 NPT	4,46 €	10





295.366  
Tê Soldar c/ Porca Louca  
Te Soldar c/ Racor Loco  
Welding Tee w/ Loose Nut  
Té Souder a/ Écrou Tournant

Ref.		€/Un.	
0295.3661	12x20-1,5	4,55 €	5
0295.3662	15x20-1,5	4,55 €	5
0295.3663	18x20-1,5	5,77 €	5
0295.3664	22x20-1,5	8,43 €	5
0295.3665	22x1/2	7,06 €	5
0295.3666	22x3/4	8,23 €	5
0295.3667	28x20-1,5	11,66 €	5
0295.3668	28x1/2	9,37 €	5
0295.3669	28x3/4	10,66 €	5
0295.3670	28x11/4	19,89 €	5
0295.3671	35x3/4	18,89 €	5
0295.3672	35x1	19,24 €	5
0295.3673	35x11/4	19,89 €	5





295.376  
Abraçadeira p/ Electrodes  
Abrazadera p/ Electrodes  
Clamp f/ Electrodes  
Collier p/ Électrodes

Ref.		€/Un.	
0295.3761	D-16	1,29 €	5





295.373  
Pulverizador p/ Tanque GPL  
Pulverizador p/ Depósito GPL  
Tank Pulverizar GPL  
Pulvérisateur Réservoir GPL

Ref.		€/Un.	
0295.3731	1/4 PT	4,06 €	10





295.374  
Abraçadeira p/ Ligação à Terra  
Abrazadera Terra  
Clamp Earth  
Collier p/ Mise à La Terre

Ref.		€/Un.	
0295.3745	22	10,00 €	2
0295.3746	28	14,50 €	2
0295.3747	35	18,00 €	2



295.375  
Electrodos de Terra  
Electrodos  
Electrodes  
Électrodes

Ref.		€/Un.	
0295.3751	R-1,5	7,57 €	1
0295.3752	R-2	9,94 €	1

# Accesórios Gás

Accesórios Gas | Gas Accessories | Accessoires Gaz



97% Sn  
3% Cu

295EC  
Bobine Solda Estanho/Cobre  
Carrete Soldadura Estaño/Cobre  
Tin/Copper Soldering Coil  
Bobine à Souder Étain/Cuivre

Ref.		€/Un.
0295.5650	250 g	19,00 €



96,5% Sn  
3,5% Ag

295EP  
Bobine Solda Estanho/Prata  
Carrete Soldadura Estaño/Plata  
Tin/Silver Soldering Coil  
Bobine à Souder Étain/Argent

Ref.		€/Un.
0295.5655	250 g	24,00 €



295CF  
Varetas Solda Cobre/Fósforo  
Varilla Soldar Cobre/Fósforo  
Copper/Phosphorus Soldering Alloy  
Baguettes Soudure Cuivre/Phosphore

Ref.		€/Un.
0295.5670	1 Kg	39,95 €



295DG  
Decapante Gel  
Decapante Gel  
Flux Gel  
Détartran Gel

Ref.		€/Un.
0295.5660	100 g	4,70 €





295DP  
Decapante Pó  
Decapante Polvo  
Flux Powder  
Détartran Poudre

Ref.		€/Un.
0295.5665	100 g	7,60 €



295P  
Varetas Solda Prata  
Varilla Soldar Plata  
Silver Soldering Alloy  
Baguettes Soudure Argent

Ref.		€/Un.
0295.5685	0,5 Kg	







# 4

## Tratamento de Água

Tratamiento de Agua | Water Treatment | Traitement de L'eau



Potência | Potencia | Power | Puissance



Temperatura Máxima | Temperatura Máxima  
Máximum Temperature | Température Maxime



Tamanho Rosca | Tamaño Rosca  
Nut Thread Size | Dimension de Filetage



Pressão / Pressão Máxima | Presión / Presión Máxima  
Pressure / Maximum Pressure | Pression / Pression Maxime



Água Potável | Aqua Potable | Drinking Water | Eau Potable



Peso | Peso | Weight | Poids



Embalagem | Embalaje | Packaging | Emballage



Retenção de sedimentos e partículas em suspensão existentes na água superiores a X micras.  
Retención de sedimentos y partículas en suspensión existentes en el agua superiores a X micras.  
Retention of sediments and particles existing in the water higher than X microns.  
Rétention des sediments et des particules existantes dans l'eau supérieure à X microns.



Medida/Cor | Medida/Color  
Size/Colour | Mesure/Couleur



Cromado/Inox/Branco | Cromo/Inox/Blanco  
Chrome/S. S./White | Chrome/Inox/Blanc



### Kit Portafiltro 10" - 3 Peças

Kit Portafiltro 10" - 3 Piezas  
Senior Filter Kit 10" - 3 Pieces  
Kit Filtre 10" - 3 Pièces

Ref.				€/Un.	
9903.0101	1"	45°	6 bar	13,25 €	12

#### Inclui

Portafiltro 10"  
+ Chave  
+ Suporte

#### Incluye

Portafiltro 10"  
+ Llave  
+ Soporte

#### Includes

Filter Housing 10"  
+ Wrench  
+ Bracket

#### Inclut

Porte-Filtre 10"  
+ Clé  
+ Support



### Kit Portafiltro Duplo 10" - 3 Peças

Kit Portafiltro Doble 10" - 3 Piezas  
Senior Double Filter Kit 10" - 3 Pieces  
Kit Filtre Double 10" - 3 Pièces

Ref.				€/Un.	
9903.0107	1"	45°	6 bar	30,00 €	6

#### Inclui

Portafiltro Duplo 10"  
+ Chave  
+ Suporte

#### Incluye

Portafiltro Doble 10"  
+ Llave  
+ Soporte

#### Includes

Double Filter Housing 10"  
+ Wrench  
+ Bracket

#### Inclut

Porte-Filtre Double 10"  
+ Clé  
+ Support



### Kit Portafiltro Duplo 10" - 3 Peças + Cartuchos

Kit Portafiltro Doble 10" - 3 Piezas + Cartuchos  
Senior Double Filter Kit 10" - 3 Pieces + Cartridges  
Kit Filtre Double 10" - 3 Pièces + Cartouche

Ref.				€/Un.	
9903.0106	1"	45°	6 bar	34,00 €	6

#### Inclui

Portafiltro Duplo 10"  
+ Chave  
+ Suporte  
+ Cartucho Sedimentos  
+ Cartucho Carvão Activado

#### Incluye

Portafiltro Doble 10"  
+ Llave  
+ Soporte  
+ Cartucho Sedimentos  
+ Cartucho Carbón Activado

#### Includes

Double Filter Housing 10"  
+ Wrench  
+ Bracket  
+ Sediments Cartridge  
+ Activated Carbon Cartridge

#### Inclut

Porte-Filtre Double 10"  
+ Clé  
+ Support  
+ Cartouche Sédiments  
+ Cartouche Charbon Actif



**Cartucho Sedimentos 10"**  
 Cartucho Sedimentos 10"  
 Fiber Sediments Cartridge 10"  
 Cartouche Sédiments 10"

**Retenção de sedimentos e partículas em suspensão existentes na água superiores a 5 micras.**  
 Retención de sedimentos y partículas en suspensión existentes en el agua superiores a 5 micras.  
 Retention of sediments and particles existing in the water higher than 5 microns.  
 Rétenção des sédiments et des particules existantes dans l'eau supérieure à 5 microns.

Ref.		€/Un.	
9903.0117	5 μ	2,00 €	100



**Cartucho Sedimentos Bobinado 10"**  
 Cartucho Sedimentos Bobinado 10"  
 Widing Sediments Cartridge 10"  
 Cartouche Sédiments Bobiné 10"

**Retenção de sedimentos e partículas em suspensão existentes na água superiores a 5 micras.**  
 Retención de sedimentos y partículas en suspensión existentes en el agua superiores a 5 micras.  
 Retention of sediments and particles existing in the water higher than 5 microns.  
 Rétenção des sédiments et des particules existantes dans l'eau supérieure à 5 microns.

Ref.		€/Un.	
9903.0139	5 μ	3,50 €	50



**Cartucho Lavável Nylon 10"**  
 Cartucho Lavable Nylon 10"  
 Washable Nylon Cartridge 10"  
 Cartouche Lavable Nylon 10"

**Retenção de sedimentos e partículas em suspensão existentes na água superiores a 60 micras.**  
 Retención de sedimentos y partículas en suspensión existentes en el agua superiores a 60 micras.  
 Retention of sediments and particles existing in the water higher than 60 microns.  
 Rétenção des sédiments et des particules existantes dans l'eau supérieure à 60 microns.

Ref.		€/Un.	
9903.0137	60 μ	4,25 €	50



**Cartucho Carvão Activado CTO 10"**  
 Cartucho Carbón Activado 10"  
 Activated Carbon Cartridge 10"  
 Cartouche Charbon Actif 10"

**Elimina odores e sabores presentes na água e melhora a qualidade da mesma.**  
 Elimina olores y sabores presentes en el agua y mejora la calidad de la misma.  
 Eliminates odor and taste and improves the quality of water.  
 Élimine les odeurs et des saveurs dans l'eau et améliore la qualité de la même.

Ref.	€/Un.	
9903.0146	4,00 €	25



**Cartucho Silicofosfatos 10"**  
 Cartucho Silicofosfatos 10"  
 Silicophosphates Cartridge 10"  
 Cartouche Silicophosphates 10"

**Evita incrustações e corrosão nas tubagens, electrodomésticos, termos eléctricos, caldeiras de AQS, etc.**  
 Evita incrustaciones y corrosión en tuberías, electrodomésticos, termos eléctricos, calderas de ACS, etc.  
 Prevents scale and corrosion in pipes, appliances, water heaters, DHW boilers, etc.  
 Empêche tartre et la corrosion dans les tuyaux, les appareils électroménagers, chauffe-eau, chaudières ECS.

Ref.	€/Un.	
9903.0135	32,15 €	25



**Cartucho Declorador 10"**  
 Cartucho Declorador 10"  
 Dechlorinator Cartridge 10"  
 Cartouche Déchlorer 10"

**Elimina cloro e derivados orgânicos da água.**  
 Elimina cloro e derivados orgánicos del agua  
 Removes chlorine and organic derivatives from water.  
 Enlève le chlore et les dérivés organiques de l'eau.

Ref.	€/Un.	
9903.0119	6,75 €	25





### Kit Portafiltro BIG 10" - 3 Peças

Kit Portafiltro BIG 10" - 3 Piezas  
Senior BIG Filter Kit 10" - 3 Pieces  
Kit Filtre BIG 10" - 3 Pièces

Ref.				€/Un.	
9903.0108	1"	45°	8 bar	<b>51,50 €</b>	1

### Portafiltro BIG 10"

+ Chave  
+ Suporte

### Portafiltro BIG 10"

+ Llave  
+ Soporte

Filter Housing BIG 10"  
+ Wrench  
+ Bracket

Porte-Filtre BIG 10"  
+ Clé  
+ Support



### Kit Portafiltro BIG 20" - 3 Peças

Kit Portafiltro BIG 20" - 3 Piezas  
Senior BIG Filter Kit 20" - 3 Pieces  
Kit Filtre BIG 20" - 3 Pièces

Ref.				€/Un.	
9903.0109	1"	45°	8 bar	<b>77,20 €</b>	1

### Portafiltro BIG 20"

+ Chave  
+ Suporte

### Portafiltro BIG 20"

+ Llave  
+ Soporte

Filter Housing BIG 20"  
+ Wrench  
+ Bracket

Porte-Filtre BIG 20"  
+ Clé  
+ Support



### Cartucho Sedimentos BIG

Cartucho Sedimentos BIG  
Sediments Cartridge BIG  
Cartouche Sédiments BIG

Ref.			€/Un.	
9903.0141	10"	5 μ	<b>13,00 €</b>	1
9903.0143	20"	5 μ	<b>26,00 €</b>	1



### Cartucho Sedimentos Bobinado BIG

Cartucho Sedimentos Bobinado BIG  
Widing Sediments Cartridge BIG  
Cartouche Sédiments Bobiné BIG

Ref.			€/Un.	
9903.0142	10"	25 μ	<b>22,50 €</b>	1
9903.0144	20"	25 μ	<b>40,00 €</b>	1



### Chave para Filtro

Llave para Filtro  
Filter Wrench  
Clé pour Filtre

Ref.		€/Un.
9903.0151	10"	<b>3,00 €</b>
9903.0153	BIG	<b>3,90 €</b>



### Junta Borracha para Copo

Junta Goma para Vaso  
Rubber Joint for Cup  
Joint pour Verre

Ref.		€/Un.
9903.0155	10"	<b>1,80 €</b>
9903.0157	BIG	<b>2,10 €</b>

# Filtros Autolimpantes

Filtros Autolimpantes | Self-Cleaning Filters | Filtrés Autonettoyant



Filtro Autolimpante c/ Manómetro  
Filtro Autolimpante c/ Manómetro  
Self-Cleaning Filter w/ Pressure Gauge  
Filtre Autonettoyant a/ Manomètre

Ref.		€/Un.	
9903.0180	3/4"-1"	30,00 €	1

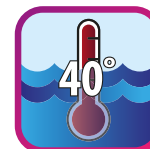

Corpo Latão  
Cuerpo Latón  
Brass Body  
Corps Laiton



Filtro Autolimpante c/ Redutor de Pressão  
Filtro Autolimpante c/ Reductor de Presión  
Self-Cleaning Filter w/ Pressure Reducer  
Filtre Autonettoyant a/ Régulateur de Pression

Ref.		€/Un.	
9903.0185	3/4"-1"	70,00 €	1

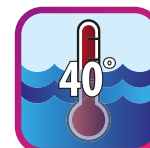

Corpo Latão  
Cuerpo Latón  
Brass Body  
Corps Laiton



Filtro para Filtro Autolimpante  
Filtro para Filtro Autolimpante  
Filter for Self-Cleaning Filter  
Filtre pour Filtre Autonettoyant

Ref.	€/Un.	
9903.0190	6,50 €	1



### Minifiltro Silicofosfatos p/ Esquentadores

Minifiltro Silicofosfatos p/ Calentador  
Silicophosphates Minifilter f/ Water Heaters  
Mini-Filtre Silicophosphates p/ Chauffe-Eau

Ref.				€/Un.	
9903.0127	1/2"	5 bar	Blister	14,20 €	20
9903.0128	1/2"	5 bar	Box - 20	257,50 €	1



### Minifiltro Silicofosfatos p/ Electrodomésticos

Minifiltro Silicofosfatos p/ Electrodomésticos  
Silicophosphates Minifilter f/ Domestic Appliances  
Mini-Filtre Silicophosphates p/ Électroménager

Ref.				€/Un.	
9903.0125	3/4"	5 bar	Blister	10,50 €	20
9903.0126	3/4"	5 bar	Box - 20	186,00 €	1



### Minifiltro Sedimentos Malha Aço 5"

Minifiltro Sedimentos Malla Acero 5"  
Sediments Filter w/ Steel Mesh 5"  
Mini-Filtre Sédiments Maille d'Acier 5"

Ref.				€/Un.	
9903.0129	3/4"	6 bar	75 µ	19,50 €	25



### Filtro Malha Aço 5"

Filtro Malla Acero 5"  
Iron Mesh Filter 5"  
Filtremaille D'Acier 5"

Ref.		€/Un.	
9903.0131	75 µ	6,00 €	25



### Carga Silicofosfato

Recarga Silicofosfatos  
Silicophosphates Charge  
Rechange Silicophosphates

Ref.		€/Un.	
9903.0133	500 g	13,75 €	1



# 5

## Aquecimento

Calefacción | Heating | Chauffage



Potência | Potencia | Power | Puissance



Temperatura Máxima | Temperatura Máxima  
Máximum Temperature | Température Maxime



Variação de Temperatura | Variación de Temperatura  
Temperature Rauge | Variation de Température



Pressão / Pressão Máxima | Presión / Presión Máxima  
Pressure / Maximum Pressure | Pression / Pression Maxime



Interior Forno Chapa Aço | Interior Cámara Acero  
Steel Plate Inside Chamber | Chambre Intérieur Tôle d'Acier



Interior Forno Vermiculite | Interior Cámara Vermiculite  
Vermiculite Inside Chamber | Intérieur Vermiculite

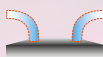

Exaustão 2 vias | Agotamiento por 2 Vías  
2 Ways Exhaustion | Épuisement 2 Sorties



Vidro Resistente 750° | Vidrio Resistente 750°  
Resistant Glass 750° | Verre Résistant 750°



Pintura Resistente a 900° | Pintura Resistente 900°  
Resistant Paint 900° | Peinture Résistante 900°



Capacidade / Volume | Capacidad / Volumen  
Capacity / Volume | Capacité / Volume



Rendimento | Rendimento  
Performance | Performance



Peso | Peso | Weight | Poids



Cumprimento Lenha | Longitud Leña  
Firewood Length | Longueur de Bois



Capacidade Pellets | Capacidad Pellets  
Pellets Capacity | Capacité Poêles



Pellets/Hora | Pellets/Hora | Pellets/Hour | Poêles/Heur



Medida/Cor | Medida/Color  
Size/Colour | Mesure/Couleur



Ø Chaminé | Ø Chimera | Ø Chimney | Ø Cheminée



Ventoinha | Ventilador | Fan | Ventilateur



Funciona a Lenha | Leña | Wood | Bois



Funciona a Pellets | Pellets | Pellets | Poêles



AQS | ACS | HWS | ECS



Aquecimento | Calefacción | Heating | Chauffage



Capacidade de Água | Capacidad de Agua  
Water Capacity | Capacité de Eau



Vaso de Expansão | Vaso Expansión  
Expansion Vessel | Vase D'Expansion



Bomba Circuladora | Bomba Circuladora  
Circulating Pump | Pompe Circulateur



Esquerda/Direita | Izquierda/Derecha  
Left/Right | Gauche/Droite



Campo Regulação | Campo Regulación  
Control Range | Plage de Réglage



Programação Automática | Programación Automática |  
Automatic Programming | Programmation Automatique



Acendimento Automático | Encendido Automático  
Automatic Ignition | Allumage Automatique



Espessura | Espesor | Thickness | Épaisseur



Aço | Acero | Steel | Acier



Cromado/Inox/Branco | Cromo/Inox/Blanco  
Chrome/S. S./White | Chrome/Inox/Blanc



# Recuperadores Aq. Central a Lenha

Insertables Leña Calefacción | Wood Central Heating Inserts | Inserts à Bois p/ Chanffage

**METLOR**

EN13229

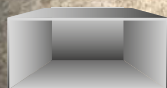

Aço / Acero / Steel / Acler



Neoceram 750°



900°



Rac24-03 (600/20)

5160.0203

1.365,00 €



26 kW + 1,3 KW



46 L



90°



3 bar



69%



190 Kg



550 mm

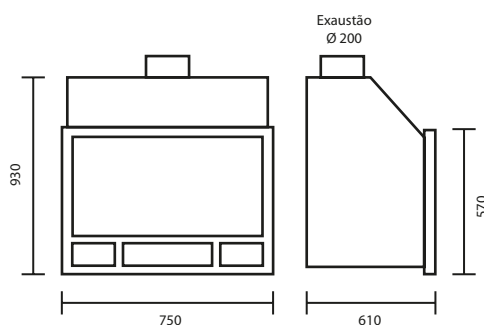

Rac24-04 (600LDA)

5160.0204

1.365,00 €



26 kW + 1,3 KW



46 L



90°



3 bar



69%



190 Kg



550 mm

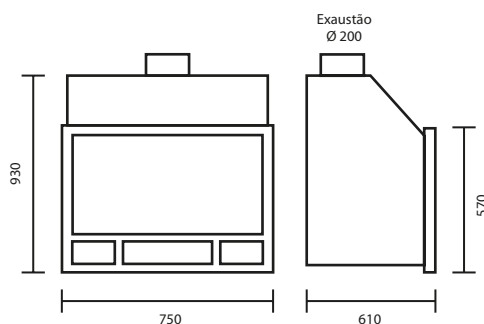

Rac24-05 (V-AC)

5160.0205

1.595,00 €



26 kW + 1,3 KW



46 L



90°



3 bar



69%



190 Kg



550 mm

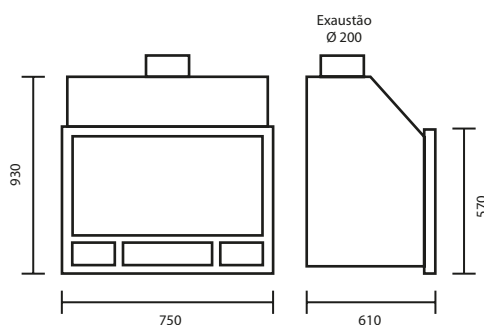

# Recuperadores Aq. Central a Lenha

Insertables Leña Calefacción | Wood Central Heating Inserts | Inserts à Bois p/ Chanffage

**METLOR**



Rac34-04 (600-34)

5160.0224 **2.225,00 €**

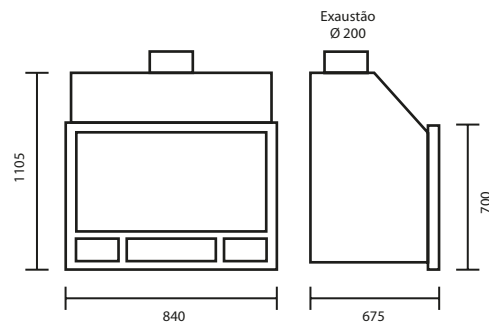
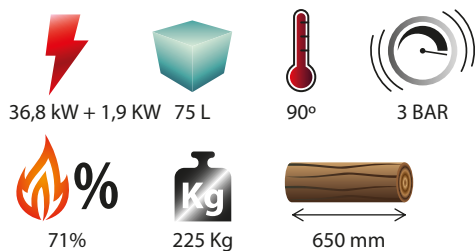

Rac20-06 (PCH)

5160.0226 **2.235,00 €**

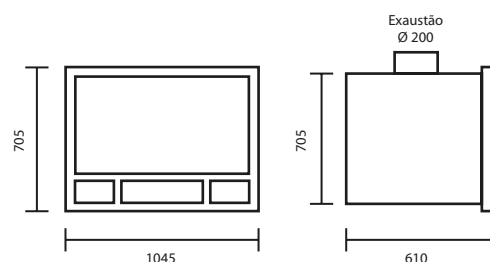
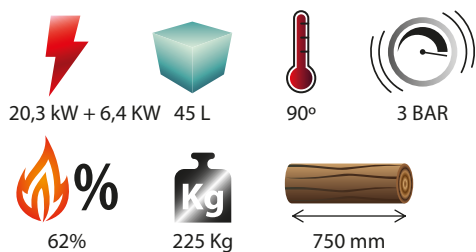

Rac20D-08 (PCH2)

5160.0228 **2.680,00 €**

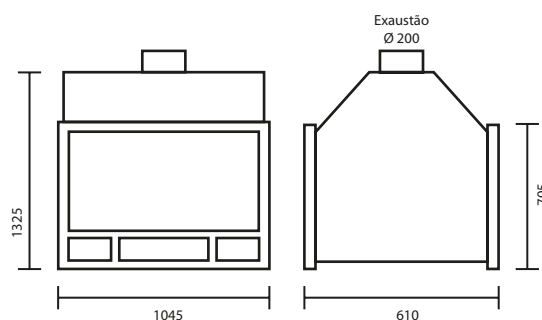
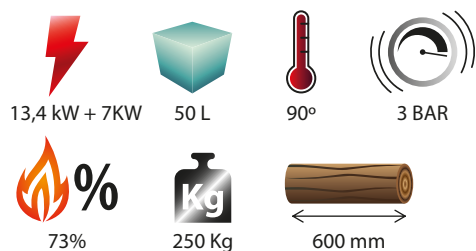

Dupla face  
Doble cara  
Double face  
Double face



Rac30G-09 (VP30)

5160.0229 **3.185,00 €**

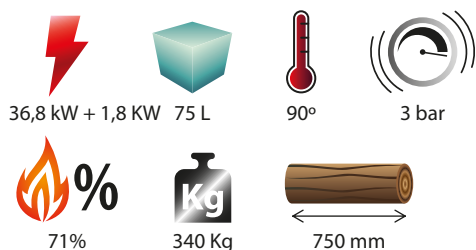

Abertura vertical  
Abertura vertical  
Vertical slide door  
Porte coulissante verticale

# Recuperadores Ventilados a Lenha

Insertables Leña Ventilados | Ventilated Wood Inserts | Inserts à Bois Ventilated

**METLOR**

EN13229



Neoceram750°



Vermiculite



900°



Raq-02 (R4A)

5160.0102 **910,00 €**



x 2



10,1 kW



%

64%



95 Kg



580 mm

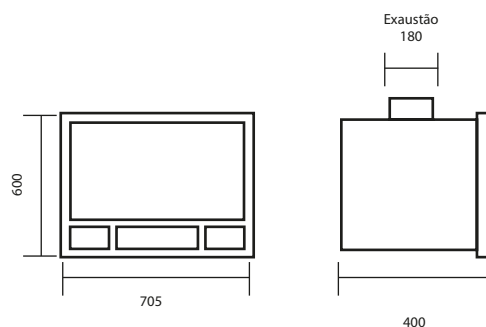

Raq-05 (R8A)

5160.0105 **830,00 €**



x 2



9,6 kW



%

64%



100 Kg



540 mm

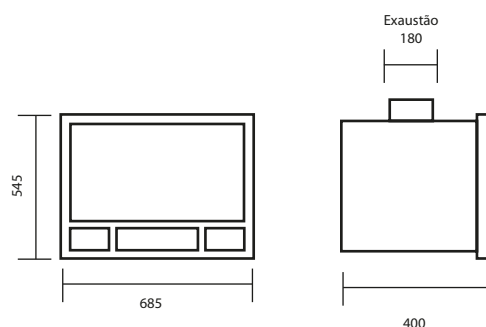



# Recuperadores Ventilados a Lenha

Insertables Leña Ventilados | Ventilated Wood Inserts | Inserts à Bois Ventilated

# METLOR



Raq-12 (LD7RC)

5160.0112

870,00 €



x 1



9 kW



64%



90 Kg



450 mm

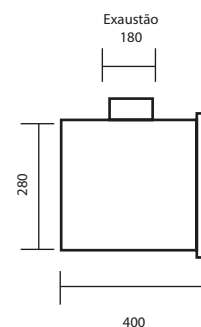
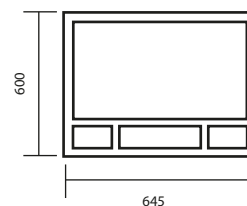

Raq-14 (LD8RC)

5160.0114

925,00 €



x 1



10,1 kW



64%



100 Kg



750 mm

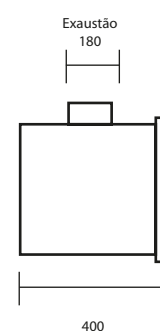
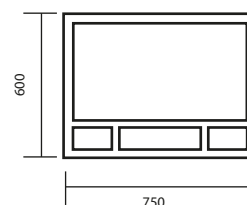

Raq-16 (LD8H)

5160.0116

1.715,00 €



x 1



14,1 kW



64%



130 Kg



820 mm

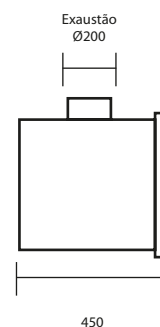
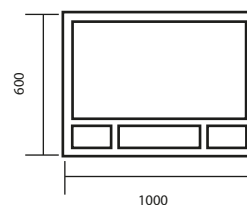

Raq-18 (VITRUS 90)

5160.0118

1.918,00 €



x 2



12,6 kW



64%



130 Kg



690 mm

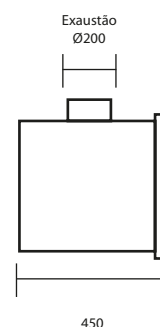
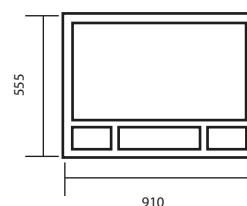



# Exemplo de Instalação - Recuperador a Lenha

Ejemplos de Instalación - Insertable Leña Aquecimento | Installation Examples - Central Heating Insert | Exemples D'Installation - Thermocheminee à Bois

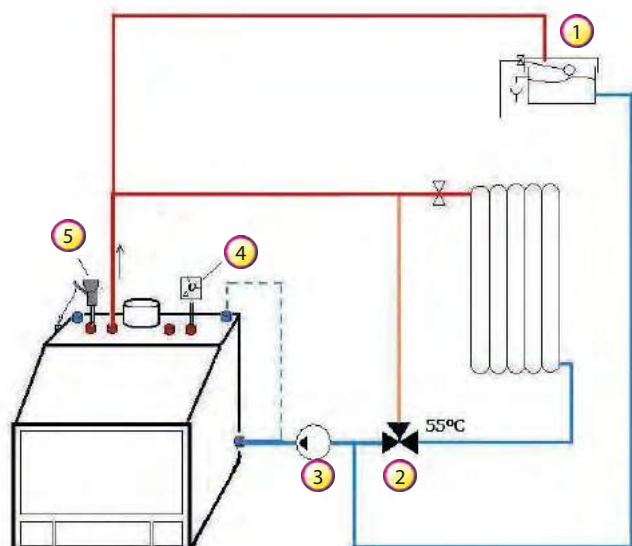

- 1 Vaso Expansão Aberto | Vaso Expansión Abierto | Open Expansion Vessel | Vase D'Expansion Ouvert
- 2 Válvula Anti-Condensação | Válvula Anti-Condensación | Anti-Condensation Valve | Vanne Anti-Condensation
- 3 Bomba Circuladora | Bomba Circuladora | Circulating Pump | Pompe Circulateur
- 4 Termostato p/Bomba | Termostato p/Bomba | Thermostat f/Pump | Thermostat p/Pompe
- 5 Regulador de Tiro | Regulador de Tiro | Draft Regulator | Regulateur de Tirage

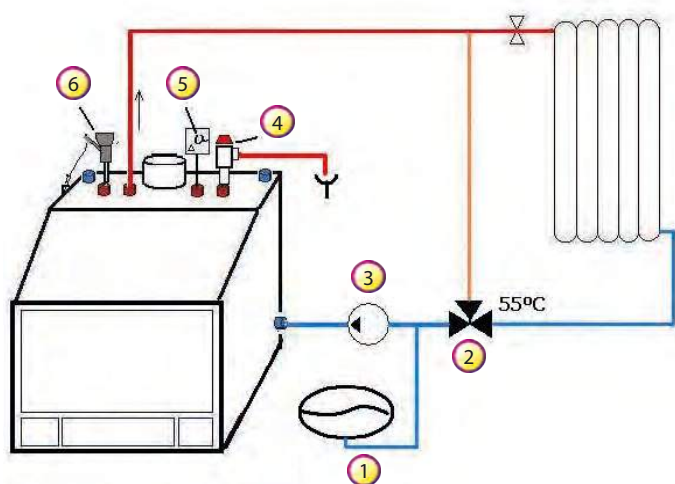

- 1 Vaso Expansão Fechado-Aquecimento | Vaso Expansión Cerrado-Calefacción | Expansion Vessel-Heating | Vase D'Expansion-Chauffage
- 2 Válvula Anti-Condensação | Válvula Anti-Condensación | Anti-Condensation Valve | Vanne Anti-Condensation
- 3 Bomba Circuladora | Bomba Circuladora | Circulating Pump | Pompe Circulateur
- 4 Válvula Segurança 90°/3Bar | Válvula Seguridad 90°/3Bar | Safety Valve 90°/3Bar | Soupape de Sécurité 90°/3Bar
- 5 Termostato p/Bomba | Termostato p/Bomba | Thermostat f/Pump | Thermostat p/Pompe
- 6 Regulador de Tiro | Regulador de Tiro | Draft Regulator | Regulateur de Tirage

# Exemplo de Instalação - Caldeira a Pellets

Ejemplos de Instalación - Caldera de Pellets | Installation Examples - Boiler Pellet Stove | Exemples D'Installation - Thermopoêle à Granules

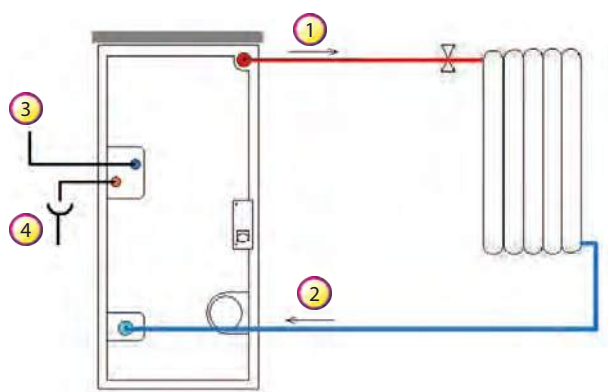

- 1 Ida AQ | Ida AC | HW Going | Aller EC
- 2 Retorno AQ | Retorno AQ | HW Return | Retour EC
- 3 Água de Rede | Aqua de Red | Mains Water | Eau de Ville
- 4 Esgoto | Desagüe | Drainage | Drainage

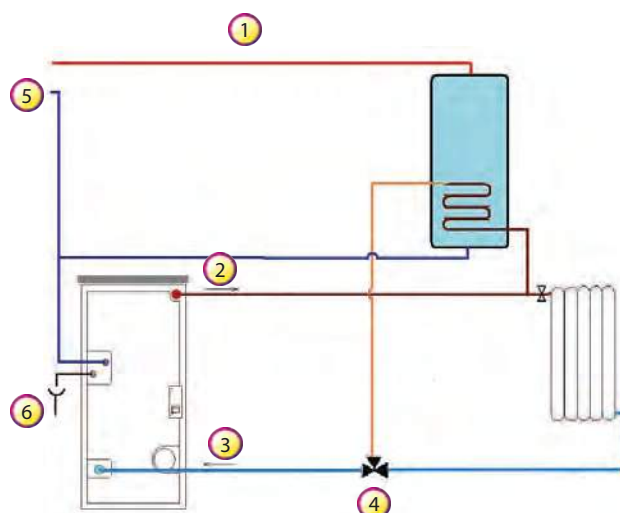

- 1 AQS | ACS | DHW | ECS
- 2 Ida AQ | Ida AC | HW Going | Aller EC
- 3 Retorno AQ | Retorno AQ | HW Return | Retour EC
- 4 Válv. Termostática | Válv. Termostática | Thermostatic Valve | Vanne Thermostatique
- 5 Água de Rede | Aqua de Red | Mains Water | Eau de Ville
- 6 Esgoto | Desagüe | Drainage | Drainage

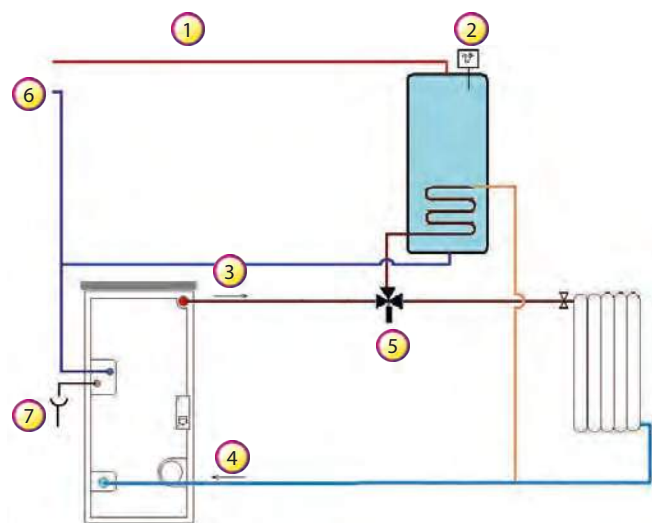

- 1 AQS | ACS | DHW | ECS
- 2 Termostato | Termostato | Thermostat | Thermostat
- 3 Ida AQ | Ida AC | HW Going | Aller EC
- 4 Retorno AQ | Retorno AQ | HW Return | Retour EC
- 5 Válv. 3 Vias Eléct. | Válv. 3 Vías Eléct. | Elect. 3 ways Valve | Vanne 3 Vois Elect.
- 6 Água de Rede | Aqua de Red | Mains Water | Eau de Ville
- 7 Esgoto | Desagüe | Drainage | Drainage

# Salamandras a Lenha

Estufas de Lenha | Wood Burning Stoves | Poêles à Bois

## METLOR

EN13240

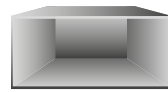

Aço / Acero / Steel / Acier



Neoceram 750°



900°



SL-03 (S800)

5160.0303 **465,00 €**

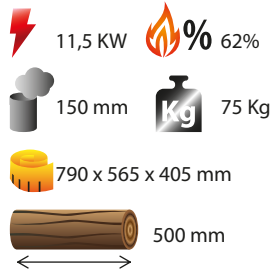

SL-01 (S710)

5160.0301 **500,00 €**



SCF-02 (S990)

5160.0502 **715,00 €**

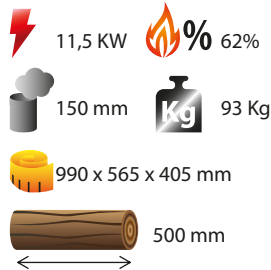

SCF-01 (S990C)

Canto | Canto | Corner | Coin

5160.0501 **715,00 €**

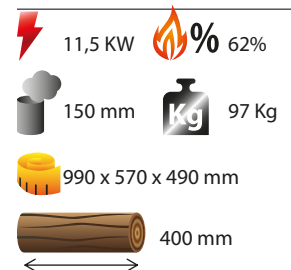

SL-02 (S730)

Canto | Canto | Corner | Coin

5160.0302 **500,00 €**

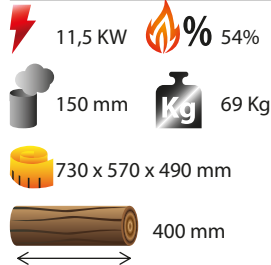

SL-09 (TUGA)

5160.0309 **680,00 €**

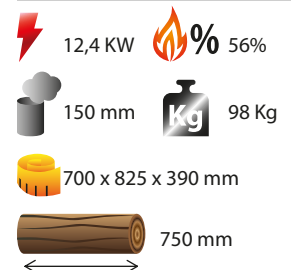

EURO

5160.0630 **440,00 €**

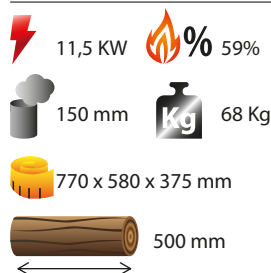

**Exclusões de garantia** Condiciones de Garantía | Warranty Conditions | Conditions de Garantie

**Obrigatoriedade de utilização do primeiro tubo com registo | Vidros vedantes e danos estruturais por excesso de combustão**

Es obligatorio utilizar el primer tubo de salida con llave | Vidros, cordones y daños estructurales por exceso de combustión no están cubiertos por la garantía

It is mandatory to install the first pipe with key | Glasses, cords and structure damages caused by excess combustion are not covered

Est obligatoire l'utilisation du premier tube avec clé | Verves, cordes et dommages de structure causée par la combustion en excés ne sont convertis por la garantie

**(Colocar lenha em demasia na área de combustão diminui a duração da salamandra e provoca danos irreversíveis)**

(Colocar lenha en exceso en la cámara de combustión disminuye la vida de la estufa y provoca daños irreversibles)

(To put wood in excess in the combustion chamber will affect the life of stove and cause irreversible damages)

(De metre le bois en excés dans la chambre de combustion affectera la vie de la poêle et causera dommages irréversibles)

# Salamandras a Pellets

Estufas a Pellets | Pellets Burning Stoves | Poêles à Graunles

EN60335-2-102

# METLOR



**SPAQ-01**

5160.0701		<b>2.140,00 €</b>
5160.0702		<b>2.140,00 €</b>
5160.0703		<b>2.140,00 €</b>

**9,6 kW** **89%** **110 Kg**

**80 mm** **820-2250 g/h**

**960 x 505 x 450 mm** **18 Kg**

**SMTWTFSS** **AM**



**SPAQ-ECO**

5160.0733	<b>1.845,00 €</b>
-----------	-------------------

**7,7 kW** **89%** **105 Kg**

**80 mm** **600-1900 g/h**

**930 x 510 x 535 mm** **15 Kg**

**SMTWTFSS** **AM**

# Caldeiras a Pellets

Calderas de Pellets | Pellets Boilers | Thermopoêles à Graunles

# Caldeira a Lenha

Caldera de Lenha | Wood Burning Boiler | Chaudière à Bois



**Bioconfort**

5160.0750	<b>5.850,00 €</b>
-----------	-------------------

**32 kW** **83%** **275 Kg**

**80 mm** **600-8300 g/h**

**1020 x 660 x 1096 mm** **90°**

**40 L** **80 Kg** **18 L**

**SMTWTFSS** **AM**



**CP15**

5160.0903	<b>2.700,00 €</b>
-----------	-------------------

**15 kW** **89%** **195 Kg**

**80 mm** **1600-5100 g/h**

**1060 x 625 x 605 mm**

**35 Kg** **18 L**

**SMTWTFSS** **AM**



**CL30**

5160.0901	<b>2.250,00 €</b>
-----------	-------------------

**29 kW** **83%** **400 Kg**

**180 mm** **500 mm**

**1223 x 600 x 975 mm**

\* Opcional - permutador de placas AQS 22 KW  
 Opcional - intercambiador de calor de placas para ACS 22 KW  
 Optional - plate heat exchanger for DHW 22 KW  
 En option - échangeur de chaleur à plaques pour l'eau chaude sanitaire



# Acessórios de Instalação

Accesorios de Instalación | Installation Accessories | Accessoires d'Installation



6024  
Torneira Descarga Caldeira  
Válvula Descarga Caldera  
Drain Cock Ball Valve  
Vanne Télécharger Chaudière

Ref.		€/Un.	
6024.0003	1/2	2,30 €	12



9907KJ  
Kit Junção p/ Bomba Circuladora  
Kit Racor p/ Bomba Circuladora  
Circulating Pump Joint Kit  
Connexion Pompe Kit

Ref.		€/Un.	
9907.0800	1	7,45 €	5



9907JS  
Junção c/ Retenção p/ Bomba Circuladora  
Racor c/ Retención p/ Bomba Circuladora  
Pump Isolating Joint  
Connexion Pompe a/ Rétenion

Ref.		€/Un.	
9907.0810	1"	10,11 €	10



1002  
Purgador Automático Mediano  
Purgador Automático Mediano  
Automatic Air Vent  
Purgeur Haut de Colonne

Ref.		€/Un.	
0337.0203	1/2	5,66 €	16



1063  
Vávula Segurança M/F  
Válvula Seguridad M/H  
Safety Valve M/F  
Soupape de Sécurité M/F

Ref.		€/Un.	
0337.0905	1/2x3	4,97 €	10
0337.0909	1/2x6	4,97 €	10
0337.0910	1/2x7	8,60 €	10
0337.0911	1/2x8	8,60 €	10



1062  
Vávula Segurança F/F  
Válvula Seguridad H/H  
Safety Valve F/F  
Soupape de Sécurité F/F

Ref.		€/Un.	
0337.0805	1/2x3	4,97 €	10
0337.0809	1/2x6	4,97 €	10
0337.0810	1/2x7	8,60 €	10
0337.0811	1/2x8	10,34 €	10



977  
Redutora de Pressão MIGNON  
Reductora de Presión MIGNON  
Press Reducer MIGNON  
Réducteur de Pression MIGNON

Ref.		€/Un.	
0340.0302	1/2	17,00 €	8
0340.0303	3/4	18,00 €	8



1055  
Vávula Segurança p/ Termoacumulador  
Válvula Seguridad p/ Termoacumulador  
Safety Valve f/ Water Heater  
Soupape de Sécurité p/ Chauffe-Eau

Ref.		€/Un.
0337.0701	1/2 M/F	4,00 €
0337.0702	3/4 M/F	8,17 €

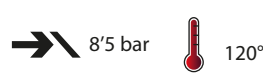
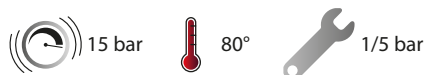

316M  
Vávula Redutora Pressão EASYRID  
Reductor de Presión EASYRID  
Press Reducer EASYRID  
Réducteur de Pression EASYRID

Ref.		€/Un.	
0316.0203	1/2	12,06 €	1

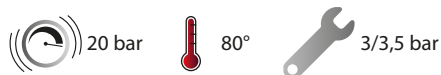

456EI  
Grupo Enchimento EASYFILL  
Grupo Llenado EASYFILL  
Filling Group EASYFILL  
Groupe de Remplissage EASYFILL

Ref.		€/Un.	
0456.0515	1/2	22,50 €	1

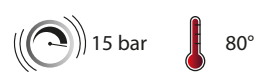

# Acessórios de Instalação

Acessórios de Instalación | Installation Accessories | Accessoires d'Installation



FARG

**316**  
Redutora Pressão  
Reductora de Presión  
Press Reducer  
Réducteur de Pression

Ref.		€/Un.	
0316.0103	1/2	25,10 €	8
0316.0104	3/4	27,50 €	8
0316.0105	1	44,15 €	2
0316.0106	1 1/4	73,00 €	2
0316.0107	1 1/2	75,50 €	1
0316.0108	2	139,00 €	1

25 bar 80° 0,5/5 bar



100°

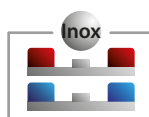

**TT326**  
Passador Esfera c/ Porca  
Válvula Esfera c/ Racor  
Ball Valve w/ Nut  
Vanne à Sphère a/ Écrou

Ref.			€/Un.	
6026.0003	1/2		4,00 €	12
6026.0004	3/4		6,70 €	8
6026.0005	1		10,50 €	5
6026.0023	1/2		4,00 €	12
6026.0024	3/4		6,70 €	8
6026.0025	1		10,50 €	5



**458BI**  
Bainha Inox 1/2"  
Vaina Inox 1/2"  
S.S. Sheath 1/2"  
Gaine Inox 1/2"

Ref.		€/Un.	
0458.9302	10/8 100	19,30 €	1
0458.9303	10/8 150	20,30 €	1
0458.9312	12/10 100	19,75 €	1
0458.9313	12/10 150	20,75 €	1



Vaso de Expansão Aberto p/ Aquecimento  
Vaso Expansion Abierto p/ Calefacción  
Open Expansion Vessel f/ Heating  
Vase Expansion Ouvert p/ Chauffage

Ref.		€/Un.	
9907.0351	25	127,66 €	1

380 x 245 x 250 mm 3/4"



10 bar 95°

**9907VA**  
Vaso Expansão Fechado p/ Aquecimento  
Vaso Expansión p/ Calefacción  
Expansion Vessel f/ Heating  
Vase Expansion p/ Chauffage

Ref.		€/Un.	
9907.0332	8 L	34,04 €	1
9907.0333	12 L	38,83 €	1
9907.0334	18 L	44,26 €	1
9907.0335	24 L	52,61 €	1



10 bar 65°

**9907AQ**  
Vaso Expansão Fechado p/ AQS  
Vaso Expansión p/ ACS  
Expansion Vessel f/ DHW  
Vase Expansion p/ ECS

Ref.		€/Un.	
9907.0322	8 L	43,03 €	1
9907.0323	12 L	46,44 €	1
9907.0324	18 L	53,14 €	1
9907.0325	24 L	55,69 €	1



**9907KS**  
Kit suporte Zincado p/ Vaso Expansão  
Kit Soporte p/ Vaso Expansión  
Wall Support Kit f/ Expansion Vessel  
Kit Support Mural p/ Vase Expansion

Ref.	€/Un.	
9907.0455	30,85 €	1



Suporte com Dupla Válvula de Retenção  
p/ Vaso Expansão  
Soporte con Válvula de Retención Doble  
p/ Vaso Expansión  
Wall Support with Double Retention Valve  
f/ Expansion Vessel  
Support Mural avec Valve Double Rétenion  
p/ Vase Expansion

Ref.	€/Un.	
9907.0460	14,00 €	1

Válvula anti retorno - 3/4  
Válvula de rención - 3/4  
Check valve - 3/4  
Clapet anti-retour - 3/4

Ligação inox - 50 cm  
Acero inoxidable enlace - 50 cm  
Stainless steel link - 50 cm  
Tuyau en acier inoxydable - 50 cm

# Acessórios de Instalação

Accesórios de Instalación | Installation Accessories | Accessoires d'Installation



9909V  
Manómetro Vertical 1/4"  
Manómetro Vertical 1/4"  
Vertical Pressure Gauge 1/4"  
Manomètre Radial 1/4"



Ref.			€/Un.	
9909.0101	0-10 bar	Ø 63	3,80 €	50



9909F  
Manómetro Frontal 1/4"  
Manómetro Frontal 1/4"  
Front Pressure Gauge 1/4"  
Manomètre Axial 1/4"



Ref.			€/Un.	
9909.0111	0-10 bar	Ø 63	3,80 €	50



TC2  
Termostato Imersão  
Termostato Inmersión  
Thermostat with Plunger  
Thermostat à Immersion



Ref.			€/Un.	
0458.7744	30°/90°	110°	22,78 €	1



BR2  
Termostato de Contacto  
Termostato de Contacto  
Contact Thermostat  
Thermostat Contact



Ref.			€/Un.	
0458.7746	30°/90°	110°	15,28 €	1



TR2  
Termostato de Bulbo Capilar  
Termostato de Bulbo Capilar  
Thermostat with Capillary  
Thermostat Capillaire



Ref.			€/Un.	
0458.7745	30°/90°	110°	13,62 €	1



456T  
Termómetro Bimetalico p/ Aquecimento  
Termómetro Bimetalico p/ Calefacción  
Bimetal Thermometer f/ Heating  
Bimétallique Thermomètre p/ Chauffage

Ref.			€/Un.	
0456.0501	1/2 0-120	80°	7,75 €	1

# Manutenção e Limpeza

Mantenimiento y Limpieza | Maintenance and Cleaning | Entretien et Nettoyage



**Junta Fibra de Vidro c/ Cola**  
Junta Fibra de Vidrio c/ Cola  
Fiber Glass Joint w/ Glue  
Joint Fibre de Verre a/ Colle

Ref.		€/Un.	
5160.2015	6 mm	13,00 €	12
5160.2017	8 mm	15,00 €	12



**Pellet's Clean**  
Pellet's Clean  
Pellet's Clean  
Pellet's Clean

Ref.	€/Un.	
5160.2047	19,00 €	6



**Aspirador Cinzas**  
Aspirador Cenizas  
Ash Vacuum Cleaner  
Cendres Aspirateur

Ref.	€/Un.	
5160.2041	89,25 €	1



**1 Kg**

**Limpa Chaminés Manutenção**  
Deshollinador Mantenimiento  
Maintenance Sweeper  
Ramonage d'Entretien

Ref.	€/Un.	
5160.2037	20,00 €	1



**10 x 5 g**

**Limpa Chaminés Manutenção**  
Deshollinador Mantenimiento  
Maintenance Sweeper  
Ramonage d'Entretien

Ref.	€/Un.	
5160.2039	13,00 €	1

## Acessórios p/ Ar Condicionado

Accesórios p/Aire Acondicionado | Air Conditioner Accessories | Accessoires p/Climatiseur



**Suportes p/ Ar Condicionado**  
Soportes p/ Aire Acondicionado  
Air Conditioner Brackets  
Supports Mural de Climatiseur

Ref.		€/Par.	
9003.0104	40 x 50	12,55 €	1
9003.0105	50 x 50	13,55 €	1
9003.0106	50 x 55	15,00 €	1



**Anti-Vibradores Chão SG**  
Anti-Vibradores Suelo SG  
Floor Anti-Vibrators SG  
Plot Amortisseur SG

Ref.		€/Un.	
9004.0001	40 (M8)	3,75 €	50
9004.0002	60 (M10)	7,50 €	45



**Anti-Vibradores AG**  
Anti-Vibradores AG  
Anti-Vibrators AG  
Amortisseur AG

Ref.		€/Un.	
9004.0101	35 (M8)	3,50 €	70
9004.0102	45 (M8)	5,00 €	50



# Radiadores Toalheiros

Radiadores Toalleros | Radiator Towel Rails | Sèche-serviettes

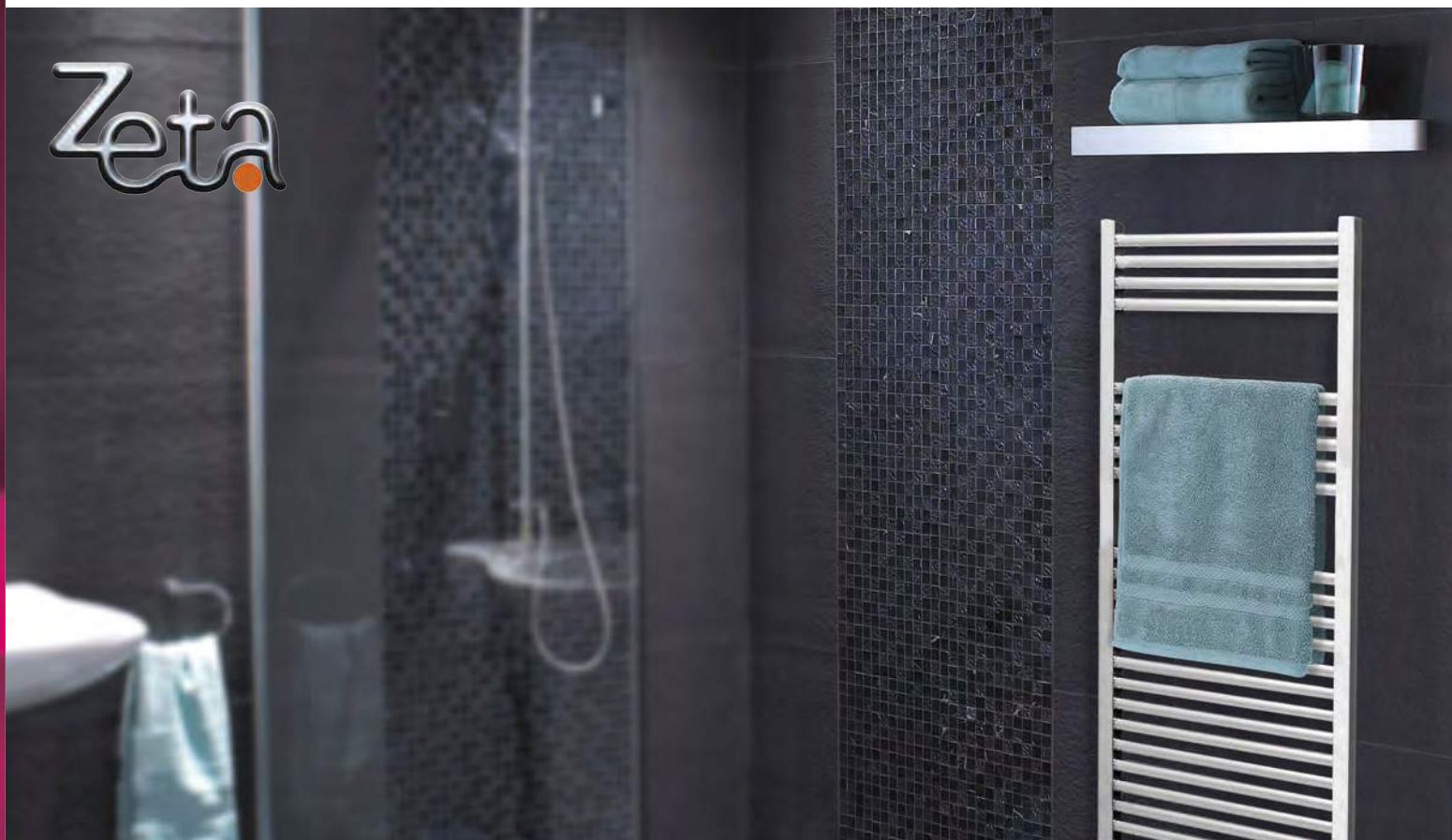
## Radiador Toalheiro Z-T Cromo

Radiador Toalheiro Z-T Cromo

Radiator Towel Rail Z-T Chrome

Radiateur p/ Serviette Z-T Chrome

Cr

Ref.		€/Un.
5006.0301	80 x 45	200,00 €
5006.0302	80 x 50	200,00 €
5006.0314	120 x 45	250,00 €
5006.0316	120 x 50	250,00 €
5006.0321	160 x 45	337,00 €
5006.0322	160 x 50	337,00 €
5006.0327	180 x 45	389,00 €
5006.0328	180 x 50	389,00 €



## Radiador Toalheiro Z-T Branco

Radiador Toalheiro Z-T Branco

Radiator Towel Rail Z-T White

Radiateur p/ Serviette Z-T Blanc

Br

Ref.		€/Un.
5006.0101	80 x 45	77,00 €
5006.0102	80 x 50	77,00 €
5006.0106	120 x 45	106,00 €
5006.0103	120 x 50	106,00 €
5006.0105	160 x 45	163,00 €
5006.0104	160 x 50	163,00 €
5006.0107	180 x 45	223,00 €
5006.0108	180 x 50	223,00 €



## Radiador Toalheiro Z-X Cromo

Radiador Toalheiro Z-X Cromo

Radiator Towel Rail Z-X Chrome

Radiateur p/ Serviette Z-X Chrome

Cr

Ref.		€/Un.
5006.0331	77 x 45	157,00 €
5006.0332	77 x 50	160,00 €
5006.0341	112 x 45	175,00 €
5006.0342	112 x 50	180,00 €



## Radiador Toalheiro Z-X Branco

Radiador Toalheiro Z-X Branco

Radiator Towel Rail Z-X White

Radiateur p/ Serviette Z-X Blanc

Br

Ref.		€/Un.
5006.0121	77 x 45	57,00 €
5006.0122	77 x 50	57,00 €
5006.0131	112 x 45	83,00 €
5006.0132	112 x 50	83,00 €

# Radiadores Toalheiros Eléctricos

Radiadores Toalleros Eléctricos | Electric Radiator Towel Rails | Sèche-serviettes Électriques



Z-T Eléctrico ON/OFF Cromo  
Z-T Eléctrico ON/OFF Cromo  
Z-T Electric ON/OFF Chrome  
Z-T Électrique ON/OFF Chrome

Cr

Ref.		€/Un.
5006.0411	80 x 45	<b>312,00 €</b>
5006.0413	120 x 45	<b>399,00 €</b>



Z-T Eléctrico ON/OFF Branco  
Z-T Eléctrico ON/OFF Branco  
Z-T Electric ON/OFF White  
Z-T Électrique ON/OFF Blanc

Br

Ref.		€/Un.
5006.0401	80 x 45	<b>199,00 €</b>
5006.0403	120 x 45	<b>248,00 €</b>

Radiador Toalheiro Z-T Branco  
Radiador Toalheiro Z-T Blanco  
Radiator Towel Rail Z-T White  
Radiateur p/ Serviette Z-T Blanc



Z-T Eléctrico Termostato Cromo  
Z-T Eléctrico Termostato Cromo  
Z-T Electric Thermostat Chrome  
Z-T Électrique Thermostat Chrome

Cr

Ref.		€/Un.
5006.0431	80 x 45	<b>355,00 €</b>
5006.0433	120 x 45	<b>427,00 €</b>



Z-T Eléctrico Termostato Branco  
Z-T Eléctrico Termostato Branco  
Z-T Electric Thermostat White  
Z-T Électrique Thermostat Blanc

Br

Ref.		€/Un.
5006.0421	80 x 45	<b>237,00 €</b>
5006.0423	120 x 45	<b>283,00 €</b>

# Kit Válvulas p/ Radiador Toalheiro

Kit Válvulas p/ Radiador Toallero | Valves Kit f/ Towel Rail Radiator | Kit Vannes p/ Séche-Serviets



**5007KM**  
**Kit Válvula Manual + Detentor 1/2"**  
 Kit Válvula Manual  
 Kit Manual Valve  
 Kit Vanne Manuel

Ref.	€/Un.	
5007.0715	<b>30,00 €</b>	1

Inclui:

Válvula cromo - 1/2" x 1/2"  
 Detentor - 1/2" x 1/2"

2 x casquilhos Cr. p/ tubo de cobre - 1/2" x Ø15  
 2 x casquilhos cromo para tubo multicamada PEX - 1/2" x Ø16

Incluye:

Válvula cromo - 1/2" x 1/2"  
 Detentor - 1/2" x 1/2"

2 x adaptador p/tubo de cobre cromo - 1/2" x Ø15  
 2 x adaptador cromo para tubería PEX multicapa - 1/2" x Ø16

Includes:

Chrome valve - 1/2" x 1/2"  
 Lockshield - 1/2" x 1/2"

2 x chrome copper pipe adapter - 1/2" x Ø15  
 2 x chrome adapter for multilayer PEX pipe - 1/2" x Ø16

Inclut:

Valve chrome - 1/2" x 1/2"  
 Vanne anti-reflux - 1/2" x 1/2"

2 x adaptateur chromée p/tuyau cuivre - 1/2" x Ø15  
 2 x adaptateur chromée p/tuyau multicouche - PEX 1/2" x Ø16



**5007KT**  
**Kit Válvula Termostática + Detentor Angular 1/2"**  
 Kit Válvula Termostática  
 Kit Thermostatic Valve  
 Kit Vanne Thermostatique

Ref.	€/Un.	
5007.0717	<b>60,00 €</b>	1

Inclui:

Válvula termostática - 1/2" x 1/2"  
 Detentor - 1/2" x 1/2"

2 x casquilhos Cr. p/ tubo de cobre - 1/2" x Ø15  
 2 x casquilhos cromo para tubo multicamada PEX - 1/2" x Ø16

Incluye:

válvula termostática - 1/2" x 1/2"  
 Detentor - 1/2" x 1/2"

2 x adaptador p/tubo de cobre cromo - 1/2" x Ø15  
 2 x adaptador cromo para tubería PEX multicapa - 1/2" x Ø16

Includes:

Thermostatic valve - 1/2" x 1/2"  
 Lockshield - 1/2" x 1/2"

2 x chrome copper pipe adapter - 1/2" x Ø15  
 2 x chrome adapter for multilayer PEX pipe - 1/2" x Ø16

Inclut:

Vanne thermostatique - 1/2" x 1/2"  
 Vanne anti-reflux - 1/2" x 1/2"

2 x adaptateur chromée p/tuyau cuivre - 1/2" x Ø15  
 2 x adaptateur chromée p/tuyau multicouche - PEX 1/2" x Ø16



**5007AE**  
**Kit Água/Elétrico**  
 Kit Aqua/Eléctrico  
 Kit Water/Electric  
 Kit Eau/Électrique

Ref.	€/Un.	
5007.0719	<b>223,80 €</b>	1

Inclui:

Válvula mista - 1/2" x 1/2"  
 Detentor - 1/2" x 1/2"  
 Resistência com termostato - 600W

2 x casquilhos Cr. p/ tubo de cobre - 1/2" x Ø15  
 2 x casquilhos cromo para tubo multicamada PEX - 1/2" x Ø16

Incluye:

Válvula mixta - 1/2" x 1/2"  
 Detentor - 1/2" x 1/2"  
 Resistencia con termostato - 600W

2 x adaptador p/tubo de cobre cromo - 1/2" x Ø15  
 2 x adaptador cromo para tubería PEX multicapa - 1/2" x Ø16

Includes:

Mixed valve - 1/2" x 1/2"  
 Lockshield - 1/2" x 1/2"  
 resistance with thermostat - 600W

2 x chrome copper pipe adapter - 1/2" x Ø15  
 2 x chrome adapter for multilayer PEX pipe - 1/2" x Ø16

Inclut:

Vanne mixte - 1/2" x 1/2"  
 Vanne anti-reflux - 1/2" x 1/2"  
 Résistance avec thermostat - 600W

2 x adaptateur chromée p/tuyau cuivre - 1/2" x Ø15  
 2 x adaptateur chromée p/tuyau multicouche - PEX 1/2" x Ø16



# Acessórios p/ Radiadores Toalheiros

Accesórios p/ Radiadores Toalleros | Accessories f/ Towel Rails | Accessoires p/ Sèche-Serviettes



**5007PQ**  
Porta Toalhas Quadrado  
Portatoallas Cuadrado  
Square Towel Holder  
Porte-Serviette Carré

Cr

Ref.		€/Un.	
5007.0707	45	18,00 €	1
5007.0709	50	19,00 €	1



**5007PR**  
Porta Toalhas Redondo  
Portatoallas Redondo  
Round Towel Holder  
Porte-Serviette Ronde

Cr

Ref.		€/Un.	
5007.0711	45	17,00 €	1
5007.0713	50	18,00 €	1



**5007KC**  
Kit Cabides  
Kit Perchas  
Hanging Kit  
Kit Cintre

Cr

Ref.	€/Un.	
5007.0705	4,50 €	20



**5007CT**  
Kit Cobretubos  
Kit Cubretubos  
Pipe Cover Kit  
Protection des Tuyaux

Cr

Ref.	€/Un.	
5007.0703	5,49 €	10



**5007AC**  
Kit Adaptador p/ Tubo Cobre  
Kit Adaptador p/ Tubo Cobre  
Copper Pipe Adapter Kit  
Kit Adapteur p/ Tube de Cuivre

Cr

Ref.		€/Un.	
5007.0737	15x1/2	2,00 €	10



**5007AM**  
Kit Adaptador p/ Tubo Pex/Multicamada  
Kit Adaptador p/ Tubo Pex/Multicapa  
Pex/Multilayer Pipe Adapter Kit  
Kit adapteur p/ Tube de Pex/Multicouche

Cr

Ref.		€/Un.	
5007.0739	16x1/2	2,00 €	10



**5007SC**  
Kit Suporte + Purgador (Cromo)  
Kit Soporte + Purgador (Cromo)  
Kit Support + Air Vent (Chrome)  
Kit Suport + Purgeur (Chrome)

Cr

Ref.	€/Un.	
5007.0743	24,00 €	10



**5007SB**  
Kit Suporte + Purgador (Branco)  
Kit Soporte + Purgador (Blanco)  
Kit Support + Air Vent (White)  
Kit Suport + Purgeur (Blanc)

Br

Ref.	€/Un.	
5007.0741	19,00 €	10



# Radiador Alumínio e Acessórios

Radiador Alumínio y Accesorios | Aluminium Radiator and Accessories | Radiateur Aluminium et Accessoires



6 bar 100°

**Elem.**  
675 x 80 x 95 mm

5115A  
Radiador Alumínio 600  
Radiador Alumínio 600  
Aluminium Radiator 600  
Radiateur Aluminium 600

Ref.	Elem.	€/Un.
5115.0103	3	42,65 €
5115.0104	4	56,85 €
5115.0105	5	71,10 €
5115.0106	6	85,30 €
5115.0107	7	99,50 €
5115.0108	8	113,70 €
5115.0109	9	128,00 €
5115.0110	10	142,15 €
5115.0111	11	156,80 €
5115.0112	12	170,60 €

5005BR  
Tampão Redução Branco  
Tapón Reducción Blanco  
White Reduction Plug  
Bouchon de Réduction Blanche



Ref.		€/Un.	
5005.0301	1x3/8 d	0,63 €	10
5005.0302	1x3/8 e	0,63 €	10
5005.0303	1x1/2 d	0,78 €	10
5005.0304	1x1/2 e	0,78 €	10

5005ZC  
Tampão Cego Zincado  
Tapón Galvanizado  
Galvanized Plug  
Bouchon Galvanisé



Ref.		€/Un.	
5005.0107	1 →	0,49 €	10
5005.0108	1 ←	0,49 €	10

5005SU  
Suporte Universal  
Soporte Universal  
Universal Support  
Support Universel



Ref.		€/Un.	
5005.0412	75	0,71 €	100

5005SR  
Suporte Reversível  
Soporte Reversible  
Reversible Support  
Support Réversible



Ref.		€/Un.	
5005.0472	75	0,52 €	100



5005KB  
Kit Universal  
Kit Universal  
Universal Kit  
Kit Universel

Ref.		€/Un.	
5005.0310	Cr	5,70 €	10
5005.0312	Br	6,80 €	10

Inclui / Incluye / Includes / Inclut:

2x tampão redutor direito + esquerdo  
2x tapón reducción derecho + izquierdo  
2x right and left reducing plug  
2x tampon de réduction droit + gauche

purgador automático + chave para purgador  
trampa automática + tecla para atrapar  
automatic steam trap + key for steam trap  
piège automatique + clé de piège

5005ZR  
Tampão Redução Zincado  
Tapón Reducción Galvanizado  
Galvanized Reduction Plug  
Bouchon de Réduction Galvanisé



Ref.		€/Un.	
5005.0001	1x1/8 d	0,52 €	100
5005.0002	1x1/8 e	0,52 €	100
5005.0101	1x3/8 d	0,52 €	100
5005.0102	1x3/8 e	0,52 €	100
5005.0103	1x1/2 d	0,52 €	100
5005.0104	1x1/2 e	0,52 €	100

5005BC  
Tampão Cego Branco  
Tapón Blanco  
White Plug  
Bouchon Blanche



Ref.		€/Un.	
5005.0307	1 →	0,80 €	100
5005.0308	1 ←	0,80 €	100

5005SI  
Suporte Invisível  
Soporte Invisible  
Invisible Support  
Support Invisible



Ref.		€/Un.	
5005.0422	75	2,00 €	100

5005SU  
Suporte Unha  
Soporte Uña  
Bracket  
Support Ongle



Ref.		€/Un.	
5005.0473	Zinc.	0,46 €	100
5005.0474	Nylon	0,46 €	100

# Acessórios e Tubo PEX

Accesorios y Tubo PEX | Accessories and PEX Pipe | Accessoires et Tuyau PEX



**IC705**  
Purgador Manual Orientável  
Purgador Manual Orientable  
Manual Orientable Vent  
Bouchon d'Air Automatique

Ref.		€/Un.	
0458.7243	1/2	1,05 €	50



**IC716**  
Tampão Purgador  
Tapón Purgador Automático  
Automatic Air Vent Plug  
Bonchon a/ Purgen

Ref.		€/Un.	
0458.7355	1	6,25 €	10
0458.7356	1	6,25 €	10



**5005VR**  
Vedação  
Junta  
Joint  
Joint

Ref.		€/Un.	
5005.0512	1	0,16 €	100



**456TP**  
Tubo PEX  
Tubo PEX  
PEX Pipe  
Tuyaux PEX

Ref.		€/m	
0456.0102	12x2	0,90 €	100
0456.0105	16x1,8	1,36 €	100
0456.0205	16x2,2	1,40 €	100
0456.0107	20x1,9	1,64 €	100
0456.0207	20x2,8	2,09 €	100
0456.0108	25x2,3	2,06 €	50
0456.0109	32x2,9	3,32 €	50



**451**  
Adaptador PEX  
Adaptador PEX  
PEX Adapter  
Adaptateur PEX

Ref.		€/Un.	
0451.0102	12x2	2,66 €	10
0451.0117	16x2	2,66 €	10
0451.0118	16x2,2	2,66 €	10



**452**  
Caixa p/ Coletor  
Caja p/ Colector  
Manifold Box  
Coffret p/ Collecteur

Ref.		€/Un.	
0452.0101	32,5x26,5	5,30 €	1
0452.0102	46,5x26,5	6,00 €	1



**140T**  
Tubo p/ Radiador  
Tubo p / Radiador  
Radiator Pipe  
Tuyau p/ Radiateur

Ref.		€/Un.	
0140.2001	12x1/2	2,02 €	10
0140.2002	14x1/2	2,24 €	10
0140.2003	15x1/2	2,05 €	10



**142A**  
Espelho  
Florón  
Rosette  
Rosette

Ref.		€/Un.	
0142.0112	12	0,53 €	10
0142.0114	14	0,58 €	10
0142.0115	15	0,53 €	10



**450**  
Coletor p/ Sistema PEX  
Coletor p/ Sistema PEX  
Manifold f/ PEX  
Collecteur PEX

Ref.		€/m	
0450.0102	3/4x1/2 2	11,80 €	15
0450.0103	3/4x1/2 3	16,70 €	10
0450.0104	3/4x1/2 4	20,80 €	7
0450.0105	3/4x1/2 5	24,70 €	7
0450.0106	3/4x1/2 6	28,80 €	7
0450.0107	3/4x1/2 7	36,80 €	5
0450.0108	3/4x1/2 8	40,30 €	5
0450.0109	3/4x1/2 9	45,90 €	5
0450.0110	3/4x1/2 10	51,70 €	5



**451J**  
Joelho Terminal PEX  
Codo Terminal PEX  
Elbow PEX  
Coude PEX

Ref.		€/Un.	
0451.0202	1/2x12x2	3,34 €	236
0451.0217	1/2x16x2	3,34 €	806
0451.0218	1/2x16x2,2	3,34 €	50



**453**  
Caixa Terminal p/ Joelho  
Caja Terminal p/ Codo  
Terminal Cover f/ Elbow  
Capot p/ le Coude

Ref.		€/Un.	
0453.0101		0,25 €	50
0453.0102		0,25 €	50

# Tubo flexível alumínio

Tubo flexible alumínio | Aluminium duct pipe | Conduit flexible aluminium



200°

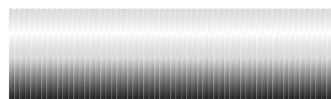

1 m

Ref.		€/Un.	
0951.0101	80	<b>2,22 €</b>	75
0951.0102	90	<b>2,31 €</b>	60
0951.0103	100	<b>2,38 €</b>	48
0951.0104	110	<b>2,53 €</b>	48
0951.0115	115	<b>2,63 €</b>	36
0951.0105	120	<b>2,78 €</b>	36
0951.0117	125	<b>2,88 €</b>	36
0951.0118	130	<b>3,03 €</b>	24

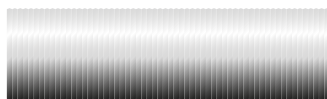

1,5 m

Ref.		€/Un.	
0952.0101	80	<b>3,31 €</b>	75
0952.0102	90	<b>3,41 €</b>	60
0952.0103	100	<b>3,50 €</b>	48
0952.0104	110	<b>3,81 €</b>	48
0952.0115	115	<b>3,88 €</b>	36
0952.0105	120	<b>4,16 €</b>	36
0952.0117	125	<b>4,31 €</b>	36
0952.0118	130	<b>4,47 €</b>	24
0952.0108	140	<b>4,50 €</b>	24

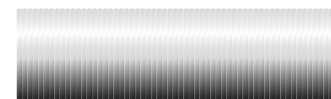

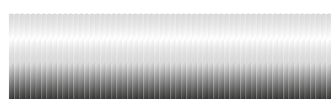

2 m

Ref.		€/Un.	
0953.0101	80	<b>4,44 €</b>	75
0953.0102	90	<b>4,50 €</b>	60
0953.0103	100	<b>4,72 €</b>	48
0953.0104	110	<b>5,06 €</b>	48
0953.0106	115	<b>5,25 €</b>	36
0953.0105	120	<b>5,50 €</b>	36
0953.0117	125	<b>5,72 €</b>	36
0953.0118	130	<b>6,09 €</b>	24



2,5 m

Ref.		€/Un.	
0954.0101	80	<b>4,78 €</b>	50
0954.0102	90	<b>4,91 €</b>	40
0954.0103	100	<b>5,41 €</b>	32
0954.0104	110	<b>5,84 €</b>	32
0954.0115	115	<b>6,00 €</b>	24
0954.0105	120	<b>6,34 €</b>	24
0954.0106	125	<b>6,78 €</b>	24
0954.0118	130	<b>6,94 €</b>	24
0954.0120	150	<b>8,09 €</b>	16
0954.0123	200	<b>11,13 €</b>	16

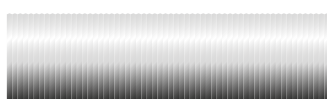

5 m

Ref.		€/m	
0950.0101	80	<b>1,84 €</b>	125
0950.0102	90	<b>1,94 €</b>	100
0950.0103	100	<b>1,97 €</b>	80
0950.0104	110	<b>2,19 €</b>	80
0950.0105	115	<b>2,28 €</b>	80
0950.0106	120	<b>2,47 €</b>	60
0950.0107	125	<b>2,56 €</b>	60
0950.0108	130	<b>2,72 €</b>	45
0950.0109	140	<b>2,94 €</b>	45
0950.0110	150	<b>3,13 €</b>	45
0950.0111	160	<b>3,56 €</b>	30
0950.0112	180	<b>4,13 €</b>	25
0950.0113	200	<b>4,69 €</b>	20
0950.0114	220	<b>4,50 €</b>	5
0950.0115	250	<b>6,55 €</b>	5



# Exaustão e Ventilação

Escape y Ventilación | Exhaust and Ventilation | Échappement et Ventilation



9900R  
Redução Alumínio  
Reducción Aluminio  
Aluminium Reduction  
Réduction Aluminium

Ref.		€/Un.	
9900.0099	80x100	2,76 €	10
9900.1000	80x110	2,76 €	10
9900.1001	90x100	2,76 €	10
9900.1002	90x120	3,16 €	10
9900.1003	100x110	3,06 €	10
9900.1004	100x120	3,26 €	10
9900.1006	110x120	3,36 €	10
9900.1007	80x120	2,76 €	10
9900.1008	90x110	2,96 €	10
9900.1009	90x115	3,16 €	10
9900.1010	90x125	3,26 €	10
9900.1011	90x130	3,26 €	10
9900.1012	100x115	3,06 €	10
9900.1013	100x125	3,36 €	10
9900.1014	100x130	3,36 €	10
9900.1015	110x125	3,36 €	10
9900.1016	110x130	3,36 €	10
9900.1017	120x125	3,36 €	10
9900.1018	120x130	3,36 €	10
9900.1019	125x130	3,36 €	10
9900.1021	110x140	3,36 €	10



9900E  
Espelho Alumínio  
Plafón Aluminio  
Aluminium Ceiling  
Plafond Aluminium

Ref.		€/Un.	
9900.1101	80	2,56 €	10
9900.1102	90	2,66 €	10
9900.1103	100	2,76 €	10
9900.1104	110	2,96 €	10
9900.1105	115	2,96 €	10
9900.1106	120	3,06 €	10
9900.1108	130	3,26 €	10



9900V  
União Alumínio  
Manguito Alumínio  
Aluminium Socket  
Jonction Aluminium

Ref.		€/Un.	
9900.1201	80	2,56 €	10
9900.1202	90	2,76 €	10
9900.1203	100	3,06 €	10
9900.1204	110	3,36 €	10
9900.1205	115	3,36 €	10
9900.1206	120	3,66 €	10
9900.1207	125	3,66 €	10
9900.1208	130	3,66 €	10



955C  
Chapéu Parede Inox c/ Grelha  
Deflector Mural Inox c/ Rejilla  
S. S. Wall Baffle w/ Grill  
Capuchon Mural Inox



Ref.		€/Un.	
955.0301	80	11,66 €	1
955.0302	90	11,72 €	1
955.0303	100	11,91 €	1
955.0304	110	12,09 €	1
955.0305	115	12,19 €	1
955.0306	120	12,25 €	1
955.0307	125	12,38 €	1
955.0308	130	12,41 €	1
955.0310	150	15,53 €	1



955G  
Girândola Inox  
Sombrerete Auto-Aspirante Inox  
S. S. Self Exhauster  
Capuchon Rotatil

Ref.		€/Un.	
0955.0401	80	56,44 €	1
0955.0402	90	57,16 €	1
0955.0403	100	57,56 €	1
0955.0404	110	57,94 €	1
0955.0405	120	58,31 €	1
0955.0406	125	58,47 €	1
0955.0407	130	58,69 €	1
0955.0409	150	67,97 €	1
0955.0412	175	68,75 €	1
0955.0413	180	68,91 €	1
0955.0414	200	69,97 €	1



955B  
Chapéu Parede Lacado Branco c/ Grelha  
Deflector Mural Lacado Blanco c/ Rejilla  
White Painted Wall Baffle w/ Grill  
Capuchon Mural Inox Laqué Blanc



Ref.		€/Un.	
955.0321	80	10,06 €	1
955.0322	90	10,31 €	1
955.0323	100	10,47 €	1
955.0324	110	10,84 €	1
955.0325	115	11,09 €	1
955.0326	120	11,28 €	1
955.0327	125	11,41 €	1
955.0328	130	11,59 €	1
955.0330	150	11,85 €	1



# Exaustão e Ventilação

Escape y Ventilación | Exhaust and Ventilation | Échappement et Ventilation



**795**  
**Fita Alumínio**  
Cinta de Aluminio  
Aluminium Tape  
Bande Aluminium

Ref.		€/Un.	
0795.0100	50x5m	1,58 €	20
0795.0101	50x50m	5,69 €	24
0795.0102	75x50m	7,99 €	36



**146I**  
**Chapa Ventilação c/ Regulador**  
Chapa Ventilación c/ Regulador  
Adjustable Air Vent  
Grille d'Évacuation d'Air Régable

Ref.		€/Un.	
Inox	Inox / S. S.		
0146.0201	15x15	3,91 €	10
Br	Branco / Blanco / White / Blanc		
0146.0203	15x15	3,60 €	10



**146A**  
**Grelha Ventilação Alumínio**  
Rejilla Ventilación Aluminio  
Aluminium Air Vent Grill  
Grille d'Évacuation d'Air Aluminium

Ref.		€/Un.	
0146.0100	15x15	1,33 €	10
0146.0102	20x20	2,33 €	10



**146B**  
**Grelha Ventilação Persiana PP**  
Rejilla Ventilación Persiana PP  
Air Vent Grill PP  
Grille d'Évacuation d'Air PP

Ref.		€/Un.	
0146.0501	15x15	0,82 €	60
0146.0511	20x20	1,53 €	60



**518GL**  
**Grelha p/ Lareira c/Aro**  
Rejilla Calefacción c/ Arco  
Heating Vent Grill  
Grille de Chanffage

Ref.		€/Un.	
5180.1020	15x15	10,34 €	10
5180.1022	14x29	11,46 €	10



**146R**  
**Grelha Redonda MULTI c/ Rede**  
Rejilla Redonda MULTI c/ Red  
Air Vent Grill w/ Net  
Grille d'Évacuation d'Air a/ Réseau

Ref.		€/Un.	
0146.0601	Ø 90-125	1,98 €	10



**518EV**  
**Válvula Extração/Admissão EV**  
Válvula Extracción/Admisión EV  
Air Extraction Valve EV  
Bouche d'Extraction et d'Insufflation EV

Ref.		€/Un.	
5180.1005	100	6,60 €	10
5180.1010	125	10,00 €	10



**518VP**  
**Válvula Extração/Admissão (PP)**  
Válvula Extracción Admisión (PP)  
Air Extraction Valve (PP)  
Bouche d'Extraction et d'Insufflation (PP)

Ref.		€/Un.	
5180.1015	90/110/125	2,60 €	36



**DECO 100**  
**Extrator Casa de Banho**  
Extractor de Baño  
Bathroom Extract Fan  
Aérateur Pour le Bain

Ref.		€/Un.	
0146.9001	100	19,01 €	1



**O. R.**  
**Extrator Casa de Banho**  
Extractor de Baño  
Bathroom Extract fan  
Aérateur p/ le Bain

Ref.		€/Un.	
0146.9005	75	18,13 €	1

# Chaminé Parede Simples

Chimenea de Pared Simple | Single Wall Chimney | Cheminée Simple Paroi



UNE-EN 1856-1:2004

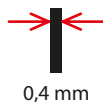

AÇO INOX #304

lenha, gás propano, gás natural, gasóleo, biogás  
temperatura de trabalho: 450°  
Isolante: lã de rocha 30 mm, 125 Kg/m<sup>3</sup>

ACERO INOXIDABLE #304

leña, propano, gas natural, diesel, biogás  
temperatura de trabajo: 450°  
Aislamiento: lana de roca de 30 mm, 125 Kg/m<sup>3</sup>

INOX #304

bois, propane, gaz naturel, diesel, biogaz  
température de travail: 450°  
Isolation: laine de roche 30 mm, 125 Kg/m<sup>3</sup>

STAINLESS STEEL #304

firewood, propane, natural gas, diesel, biogas  
working temperature: 450°  
Insulation: rock wool 30 mm, 125 Kg/m<sup>3</sup>



TI  
Tubo - 1 m  
Tubo - 1 m  
Pipe - 1 m  
Tuyau - 1 m

Ref.		€/Un.	
5212.0101	80	16,95 €	1
5212.0102	100	19,65 €	1
5212.0105	125	23,25 €	1
5212.0107	150	26,95 €	1
5212.0108	175	31,80 €	1
5212.0109	180	32,90 €	1
5212.0110	200	36,50 €	1
5212.0111	250	48,25 €	1
5212.0112	300	64,30 €	1



TI 050  
Tubo - 0,5 m  
Tubo - 0,5 m  
Pipe - 0,5 m  
Tuyau - 0,5 m

Ref.		€/Un.	
5212.0201	80	10,30 €	1
5212.0202	100	12,10 €	1
5212.0205	125	14,00 €	1
5212.0207	150	17,00 €	1
5212.0208	175	19,85 €	1
5212.0209	180	20,65 €	1
5212.0210	200	22,30 €	1
5212.0211	250	28,15 €	1
5212.0212	300	36,50 €	1



TI 025  
Tubo - 0,25 m  
Tubo - 0,25 m  
Pipe - 0,25 m  
Tuyau - 0,25 m

Ref.		€/Un.	
5212.0301	80	6,70 €	1
5212.0302	100	7,70 €	1
5212.0305	125	9,05 €	1
5212.0307	150	11,00 €	1
5212.0308	175	13,05 €	1
5212.0309	180	13,95 €	1
5212.0310	200	14,25 €	1
5212.0311	250	19,65 €	1
5212.0312	300	24,00 €	1



TEI  
Tubo Extensível  
Tubo Extensible  
Extensible Pipe  
Tuyau Extensible

Ref.		€/Un.	
5212.0401	80	21,05 €	1
5212.0402	100	22,30 €	1
5212.0405	125	25,80 €	1
5212.0407	150	29,20 €	1
5212.0408	175	32,00 €	1
5212.0409	180	38,65 €	1
5212.0410	200	38,75 €	1
5212.0411	250	48,00 €	1
5212.0412	300	55,00 €	1



TILL  
Tubo c/ Registo - 1 m  
Tubo c/ llave - 1 m  
Pipe w/ Key - 1 m  
Tuyau a/ Clé - 1 m

Ref.		€/Un.	
5212.0127	150	38,10 €	1

# Chaminé Parede Simples

Chimenea de Pared Simple | Single Wall Chimney | Cheminée Simple Paroi



MMI  
União Macho  
Manguito Macho  
Male Sleeve  
Raccord Mâle

Ref.		€/Un.	
5212.1601	80	6,25 €	1
5212.1602	100	6,50 €	1
5212.1605	125	7,00 €	1
5212.1607	150	8,15 €	1
5212.1608	175	9,40 €	1
5212.1609	180	9,90 €	1
5212.1610	200	12,15 €	1
5212.1611	250	13,90 €	1
5212.1612	300	14,35 €	1



MHI  
União Fêmea  
Manguito Hembra  
Female Sleeve  
Raccord Femelle

Ref.		€/Un.	
5212.1501	80	6,25 €	1
5212.1502	100	6,50 €	1
5212.1505	125	7,00 €	1
5212.1507	150	8,15 €	1
5212.1508	175	9,40 €	1
5212.1509	180	9,90 €	1
5212.1510	200	12,15 €	1
5212.1511	250	13,90 €	1
5212.1512	300	14,35 €	1



CI45  
Joelho 45°  
Codo 45°  
Elbow 45°  
Coude 45°

Ref.		€/Un.	
5212.0501	80	11,55 €	1
5212.0502	100	12,40 €	1
5212.0505	125	14,25 €	1
5212.0507	150	16,65 €	1
5212.0508	175	20,80 €	1
5212.0509	180	21,50 €	1
5212.0510	200	23,80 €	1
5212.0511	250	34,75 €	1
5212.0512	300	46,20 €	1



CI90  
Joelho 90°  
Codo 90°  
Elbow 90°  
Coude 90°

Ref.		€/Un.	
5212.0601	80	13,45 €	1
5212.0602	100	15,75 €	1
5212.0605	125	18,00 €	1
5212.0607	150	22,80 €	1
5212.0608	175	27,15 €	1
5212.0609	180	28,75 €	1
5212.0610	200	33,45 €	1
5212.0611	250	43,25 €	1
5212.0612	300	55,80 €	1



TTI45  
Tê c/ Tampa 45°  
Te c/ Tapón 45°  
Tee w/ Cap 45°  
Té a/ tampon 45°

Ref.		€/Un.	
5212.0801	80	42,60 €	1
5212.0802	100	45,45 €	1
5212.0805	125	52,00 €	1
5212.0807	150	63,55 €	1
5212.0808	175	69,65 €	1
5212.0809	180	72,70 €	1
5212.0810	200	96,80 €	1
5212.0811	250	105,45 €	1
5212.0812	300	130,00 €	1



TTI90  
Tê c/ Tampa 90°  
Te c/ Tapón 90°  
Tee w/ Cap 90°  
Té a/ Tampon 90°

Ref.		€/Un.	
5212.0701	80	27,45 €	1
5212.0702	100	31,60 €	1
5212.0705	125	34,50 €	1
5212.0707	150	38,95 €	1
5212.0708	175	44,85 €	1
5212.0709	180	53,30 €	1
5212.0710	200	57,80 €	1
5212.0711	250	86,80 €	1
5212.0712	300	103,15 €	1

# Chaminé Parede Simples

Chimenea de Pared Simple | Single Wall Chimney | Cheminée Simple Paroi



**BEXI**  
Chapéu Regulável  
Sombrete Reguable  
Adjustable Cap  
Capuchon Règlable

Ref.		€/Un.	
5212.1301	80-100	20,00 €	1
5212.1302	110-130	23,00 €	1
5212.1303	140-160	25,00 €	1
5212.1304	175-200	29,00 €	1



**BI**  
Chapéu  
Sombrete  
Cap  
Capuchon

Ref.		€/Un.	
5212.1202	100	34,75 €	1
5212.1205	125	41,65 €	1
5212.1207	150	43,65 €	1
5212.1208	175	50,55 €	1
5212.1209	180	55,40 €	1
5212.1210	200	66,65 €	1
5212.1211	250	98,10 €	1
5212.1212	300	114,65 €	1



**SA**  
Chapéu Antivento  
Sombrete Antiviento  
Windproof Cap  
Capuchon Parevent

Ref.		€/Un.	
5212.1401	80	36,10 €	1
5212.1402	100	37,25 €	1
5212.1405	125	42,60 €	1
5212.1407	150	44,50 €	1
5212.1408	175	51,25 €	1
5212.1409	180	57,60 €	1
5212.1410	200	69,30 €	1
5212.1411	250	100,05 €	1
5212.1412	300	115,00 €	1



**CGP**  
Cobre Chaminé b. Chumbo 0-45°  
Cubre Chimeneas b. Plomo 0-45°  
Solín Toit en Pente 0-45°  
Shimney Sleeve 0-45°

Ref.		€/Un.	
5212.2301	80	101,00 €	1
5212.2302	100	102,60 €	1
5212.2305	125	141,60 €	1
5212.2307	150	165,05 €	1
5212.2308	175	177,00 €	1
5212.2309	180	179,00 €	1
5212.2310	200	193,60 €	1
5212.2311	250	218,50 €	1
5212.2312	300	236,70 €	1



**AI**  
Suporte c/ Parafuso  
Brida  
Clamp  
Collier

Ref.		€/Un.	
5212.1701	80	5,85 €	1
5212.1702	100	5,95 €	1
5212.1705	125	6,45 €	1
5212.1707	150	6,80 €	1
5212.1708	175	7,35 €	1
5212.1709	180	7,80 €	1
5212.1710	200	8,05 €	1
5212.1711	250	8,90 €	1
5212.1712	300	9,15 €	1



**BMGE**  
Suporte Mural Exterior  
Brida Mural Exterior  
External Wall Clamp  
Collier Mural Extérieur

Ref.		€/Un.	
5212.1901	80	16,05 €	1
5212.1902	100	18,75 €	1
5212.1905	125	19,55 €	1
5212.1907	150	25,85 €	1
5212.1908	175	26,05 €	1
5212.1909	180	26,55 €	1
5212.1910	200	32,50 €	1
5212.1911	250	44,55 €	1
5212.1912	300	49,60 €	1



# Chaminé Parede Simples

Chimenea de Pared Simple | Single Wall Chimney | Cheminée Simple Paroi



**BMG**  
Suporte Mural  
Brida Mural  
Wall Clamp  
Collier Mural

Ref.		€/Un.	
5212.1801	80	12,60 €	1
5212.1802	100	12,90 €	1
5212.1805	125	13,15 €	1
5212.1807	150	15,20 €	1
5212.1808	175	18,50 €	1
5212.1809	180	18,80 €	1
5212.1810	200	19,05 €	1
5212.1811	250	23,55 €	1
5212.1812	300	25,95 €	1



**VIG**  
Colarinho Antichuva  
Vierte Aguas  
Flashing  
Colet de Solin

Ref.		€/Un.	
5212.2001	80	17,60 €	1
5212.2002	100	18,30 €	1
5212.2005	125	19,75 €	1
5212.2007	150	21,25 €	1
5212.2008	175	21,90 €	1
5212.2009	180	22,70 €	1
5212.2010	200	24,20 €	1
5212.2011	250	27,10 €	1
5212.2012	300	32,90 €	1



**BRIVE**  
Abraçadeira  
Brida Union  
Union Clamp  
Collier d'Union

Ref.		€/Un.	
5212.2201	80	6,57 €	1
5212.2202	100	6,68 €	1
5212.2205	125	7,17 €	1
5212.2207	150	7,31 €	1
5212.2208	175	7,82 €	1
5212.2210	200	8,16 €	1
5212.2211	250	8,61 €	1
5212.2212	300	9,12 €	1



**JS**  
Junta Silicone  
Junta Silicona  
Silicone Joint  
Joint de Silicone

Ref.		€/Un.	
5202.4203	125	3,05 €	1
5202.4204	150	3,80 €	1
5202.4205	175	3,95 €	1
5202.4206	200	4,68 €	1
5202.4207	250	6,10 €	1
5202.4208	300	8,35 €	1



**CS**  
Cordão de Silicone  
Cable de Silicona  
Silicone Cord  
Cordon de Silicone

Ref.	€/m	
5212.5000	3,26 €	1

# Chaminé Parede Dupla

Chimenea de Pared Doble | Double Wall Chimney | Cheminée Double Paroi

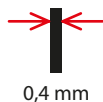

## AÇO INOX #304

lenha, gás propano, gás natural, gasóleo, biogás  
temperatura de trabalho: 450°  
Isolante: lã de rocha 30 mm, 125 Kg/m<sup>3</sup>

## ACERO INOXIDABLE #304

leña, propano, gas natural, diesel, biogás  
temperatura de trabajo: 450°  
Aislamiento: lana de roca de 30 mm, 125 Kg/m<sup>3</sup>

## INOX #304

bois, propane, gaz naturel, diesel, biogaz  
température de travail: 450°  
Isolation: laine de roche 30 mm, 125 Kg/m<sup>3</sup>

## STAINLESS STEEL #304

firewood, propane, natural gas, diesel, biogas  
working temperature: 450°  
Insulation: rock wool 30 mm, 125 Kg/m<sup>3</sup>



**TDPS**  
Tubo - 1 m  
Tubo - 1 m  
Pipe - 1 m  
Tuyau - 1 m

Ref.		€/Un.	
5202.0103	125	<b>72,85 €</b>	1
5202.0104	150	<b>87,55 €</b>	1
5202.0105	175	<b>95,45 €</b>	1
5202.0106	200	<b>108,45 €</b>	1
5202.0107	250	<b>141,80 €</b>	1
5202.0108	300	<b>173,70 €</b>	1



**TEDPI**  
Tubo extensível - 33/49  
Tubo extensible - 33/49  
Extensible pipe - 33/49  
Tuyau extensible - 33/49

Ref.		€/Un.	
5202.0403	125	<b>78,65 €</b>	1
5202.0404	150	<b>85,45 €</b>	1
5202.0405	175	<b>98,50 €</b>	1
5202.0406	200	<b>106,40 €</b>	1
5202.0407	250	<b>131,60 €</b>	1
5202.0408	300	<b>166,10 €</b>	1



**TDP505**  
Tubo - 0,5 m  
Tubo - 0,5 m  
Pipe - 0,5 m  
Tuyau - 0,5 m

Ref.		€/Un.	
5202.0203	125	<b>49,85 €</b>	1
5202.0204	150	<b>58,65 €</b>	1
5202.0205	175	<b>66,45 €</b>	1
5202.0206	200	<b>71,45 €</b>	1
5202.0207	250	<b>82,75 €</b>	1
5202.0208	300	<b>105,15 €</b>	1



**TEDPLS**  
Tubo Extensível - 55/95  
Tubo Extensible - 55/95  
Extensible Pipe - 55/95  
Tuyau Extensible - 55/95

Ref.		€/Un.	
5202.0503	125	<b>125,50 €</b>	1
5202.0504	150	<b>136,60 €</b>	1
5202.0505	175	<b>148,20 €</b>	1
5202.0506	200	<b>171,20 €</b>	1
5202.0507	250	<b>203,45 €</b>	1
5202.0508	300	<b>228,30 €</b>	1



**TDPS33**  
Tubo - 0,33 m  
Tubo - 0,33 m  
Pipe - 0,33 m  
Tuyau - 0,33 m

Ref.		€/Un.	
5202.0303	125	<b>40,75 €</b>	1
5202.0304	150	<b>44,75 €</b>	1
5202.0305	175	<b>46,30 €</b>	1
5202.0306	200	<b>51,40 €</b>	1
5202.0307	250	<b>62,70 €</b>	1
5202.0308	300	<b>75,50 €</b>	1



**CDPI15**  
Joelho 15°  
Codo 15°  
Elbow 15°  
Coude 15°

Ref.		€/Un.	
5202.0603	125	<b>47,35 €</b>	1
5202.0604	150	<b>60,50 €</b>	1
5202.0605	175	<b>62,00 €</b>	1
5202.0606	200	<b>69,60 €</b>	1
5202.0607	250	<b>84,95 €</b>	1
5202.0608	300	<b>106,55 €</b>	1

# Chaminé Parede Dupla

Chimenea de Pared Doble | Double Wall Chimney | Cheminée Double Paroi



CDPI30  
Joelho 30°  
Codo 30°  
Elbow 30°  
Coude 30°

Ref.		€/Un.	
5202.0703	125	47,35 €	1
5202.0704	150	60,50 €	1
5202.0705	175	62,00 €	1
5202.0706	200	69,60 €	1
5202.0707	250	84,95 €	1
5202.0708	300	106,55 €	1



CDPS45  
Joelho 45°  
Codo 45°  
Elbow 45°  
Coude 45°

Ref.		€/Un.	
5202.0803	125	52,15 €	1
5202.0804	150	56,85 €	1
5202.0805	175	67,10 €	1
5202.0806	200	72,75 €	1
5202.0807	250	92,75 €	1
5202.0808	300	112,25 €	1



TTDPI  
Tê c/ Purga 45°  
Te c/ Purge 45°  
Tee w/ Purge 45°  
Té a/ Purger 45°

Ref.		€/Un.	
5202.1003	125	151,40 €	1
5202.1004	150	176,05 €	1
5202.1005	175	203,35 €	1
5202.1006	200	228,65 €	1
5202.1007	250	323,85 €	1
5202.1008	300	424,25 €	1



SDPI  
Chapéu  
Sombrete  
Cap  
Capuchon

Ref.		€/Un.	
5202.1103	125	46,45 €	1
5202.1104	150	50,00 €	1
5202.1105	175	51,20 €	1
5202.1106	200	57,20 €	1
5202.1107	250	81,90 €	1
5202.1108	300	103,00 €	1



TTDPS  
Tê c/ Purga 90°  
Te c/ Purge 90°  
Tee w/ Purge 90°  
Té a/ Purger 90°

Ref.		€/Un.	
5202.0903	125	101,40 €	1
5202.0904	150	112,35 €	1
5202.0905	175	130,90 €	1
5202.0906	200	151,85 €	1
5202.0907	250	199,60 €	1
5202.0908	300	246,10 €	1



SDPAI  
Chapéu Antivento  
Sombrete Antiviento  
Windproof Cap  
Capuchon Pare-vent

Ref.		€/Un.	
5202.1203	125	71,50 €	1
5202.1204	150	80,75 €	1
5202.1205	175	93,10 €	1
5202.1206	200	95,80 €	1
5202.1207	250	104,60 €	1
5202.1208	300	124,31 €	1



ASD  
Adaptador PS-PD  
Conector SP-DP  
Connector SW-DW  
Connecteur SP-DP

Ref.		€/Un.	
5202.4103	125	8,05 €	1
5202.4104	150	9,30 €	1
5202.4105	175	11,40 €	1
5202.4106	200	11,90 €	1
5202.4107	250	14,40 €	1
5202.4108	300	13,45 €	1



SDPAI  
Colarinho Antichuva  
Vierte Aguas  
Flashing  
Colet de Solin

Ref.		€/Un.	
5202.3703	125	22,70 €	1
5202.3704	150	24,10 €	1
5202.3705	175	25,70 €	1
5202.3706	200	30,55 €	1
5202.3707	250	37,75 €	1
5202.3708	300	38,90 €	1

# Chaminé Parede Dupla

Chimenea de Pared Doble | Double Wall Chimney | Cheminée Double Paroi



**BMDP**  
Suporte Mural  
Brida Mural  
Wall Clamp  
Collier Mural Plat

Ref.		€/Un.	
5202.1303	125	<b>29,25 €</b>	1
5202.1304	150	<b>33,00 €</b>	1
5202.1305	175	<b>37,70 €</b>	1
5202.1306	200	<b>50,65 €</b>	1
5202.1307	250	<b>57,00 €</b>	1
5202.1308	300	<b>65,20 €</b>	1



**FCDPI**  
Cone Final  
Final Cónico  
Conical Chimney Top  
Capuchou Conique

Ref.		€/Un.	
5202.2903	125	<b>46,50 €</b>	1
5202.2904	150	<b>53,05 €</b>	1
5202.2905	175	<b>58,50 €</b>	1
5202.2906	200	<b>70,95 €</b>	1
5202.2907	250	<b>90,45 €</b>	1
5202.2908	300	<b>109,25 €</b>	1



**BVDP**  
Suporte Ventos  
Brida Vientos  
Wind Clamp  
Collier Vent

Ref.		€/Un.	
5202.1403	125	<b>10,00 €</b>	1
5202.1404	150	<b>10,85 €</b>	1
5202.1405	175	<b>11,85 €</b>	1
5202.1406	200	<b>13,20 €</b>	1
5202.1407	250	<b>17,00 €</b>	1
5202.1408	300	<b>18,50 €</b>	1



**PSDPI**  
Suporte Saída  
Soporte Salida  
Outlet plate  
Plaque de Finition

Ref.		€/Un.	
5202.3203	125	<b>80,00 €</b>	1
5202.3204	150	<b>80,80 €</b>	1
5202.3205	175	<b>91,40 €</b>	1
5202.3206	200	<b>108,10 €</b>	1
5202.3207	250	<b>120,40 €</b>	1
5202.3208	300	<b>136,70 €</b>	1



**SMDPI**  
Suporte Mural  
Brida Mural  
Wall Clamp  
Collier Mural Plat

Ref.		€/Un.	
5202.3103	125	<b>88,40 €</b>	1
5202.3104	150	<b>97,30 €</b>	1
5202.3105	175	<b>107,10 €</b>	1
5202.3106	200	<b>117,25 €</b>	1
5202.3107	250	<b>160,25 €</b>	1
5202.3108	300	<b>185,00 €</b>	1



**CADP45**  
Cobre Chaminé Base Chumbo 0-45°  
Cubre Chimeneas base Plomo 0-45°  
Shimney Sleeve 0-45°  
Solin Toit en Pente 0-45°

Ref.		€/Un.	
5202.2003	125	<b>210,70 €</b>	1
5202.2004	150	<b>218,30 €</b>	1
5202.2005	175	<b>223,70 €</b>	1
5202.2006	200	<b>248,70 €</b>	1
5202.2007	250	<b>256,30 €</b>	1
5202.2008	300	<b>298,60 €</b>	1



# Chaminé em Aço Vitrificado

Chimenea de Acero Esmaltado | Glazed Steel Chimney | Cheminée en Acier Émaillé



UNE-EN 1856-2:2009



Combustíveis sólidos e líquidos  
Aço vitrificados 900°  
Temperatura de trabalho: 600°

Combustibles sólidos y líquidos  
Acero esmaltado 900°  
Temperatura de trabajo: 600°

Solid and liquid fuels  
Glazed steel 900°  
working temperature: 600°

Combustibles solides et liquides  
Acier vitrifié 900°  
Température de fonctionnement: 600°

## Ø 150

TVNB  
Tubo  
Pipa  
Pipe  
Tuyau



Ref.		€/Un.	
5214.0105	1 m	26,85 €	6
5214.0205	0,5 m	20,85 €	6

TVNBLL  
Tubo c/ Registro  
Tubo c/ Llave  
Pipe w/ Key  
Tuyau a/ Clé



Ref.	€/Un.	
5214.0295	26,60 €	6

CVNB45  
Joelho 45°  
Codo 45°  
Elbow 45°  
Coude 45°



Ref.	€/Un.	
5214.0405	20,30 €	4

CVNB90  
Joelho 90°  
Codo 90°  
Elbow 90°  
Coude 90°



Ref.	€/Un.	
5214.0605	24,00 €	4

TTVNB  
Tê c/ Tampa 90°  
Te c/ Tapón 90°  
Tee w/ Cap 90°  
Té a/ Tampon 90°



Ref.	€/Un.	
5214.0705	47,60 €	6

EVNB  
Colarinho Antichuva  
Vierte Aguas  
Flashing  
Colete de Solin



Ref.	€/Un.	
5214.0805	9,00 €	6

MMV  
União Macho  
Manguito Macho  
Male Sleeve  
Raccord Mâle



Ref.	€/Un.	
5214.1005	15,60 €	6

MHV  
União Fêmea  
Manguito Hembra  
Female Sleeve  
Raccord Femelle



Ref.	€/Un.	
5214.1105	15,60 €	6

SV  
Chapéu Antivento  
Sombrente  
Cap  
Capuchon



Ref.	€/Un.	
5214.0905	32,45 €	8

# 6

## Rega e Jardim

Riego y Jardín | Irrigation and Garden | Irrigation et Jardin



Potência | Potencia | Power | Puissance



Temperatura Máxima | Temperatura Máxima  
Máximum Temperature | Température Maxime



Capacidade / Volume | Capacidad / Volumen  
Capacity / Volume | Capacité / Volume



Pressão / Pressão Máxima | Presión / Presión Máxima  
Pressure / Maximum Pressure | Pression / Pression Maxime



Verde | Verde | Vert | Green



Medida Mangueira | Medida Manguera  
Hose Size | Mesure Tuyau



Proteger das Intempéries | Proteger de la Intemperie  
Protect Against Weather | Protection Contre les Intempéries

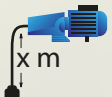

Aspiração Máxima | Aspiración Máxima  
Maximum Suction | Maxime Aspiration



Temperatura Água | Temperatura Agua  
Water Temperature | Température Eau



Temperatura Ambiente | Temperatura Ambiente  
Room Temperature | Température Ambiente



Aplicar Válvula Retenção | Aplicar Válvula Retención  
Apply Check Valve | Appliquer Clapet Non Retour



Pressão | Presión | Pressure | Pression



Caudal | Caudal | Flow | Couler



Raio | Radio | Radius | Rayon



Para Uso Doméstico | Uso Domestico  
Domestic Use | Usage Domestique



Uso Agrícola | Uso Agrícola  
Agricultural Use | Usage Agricole



Rega e Jardim | Rego y Jardín  
Irrigation and Garden | Arrosage et Jardin



Medida/Cor | Medida/Color  
Size/Colour | Mesure/Couleur



Cromado/Inox/Branco | Cromo/Inox/Blanco  
Chrome/S. S./White | Chrome/Inox/Blanc

# Fornos Exterior

Hornos Exterior | Outdoor Ovens | Four Exterieur



Inclui:  
Termómetro  
Chaminé em aço inox c/chapéu  
Pá de forno telescópica  
Tabuleiro em barro 370 x 260 x 80mm



Includes:  
Thermometer  
Stainless steel Fireplace w/Hat  
Telescopic oven shovel  
Clay Board 370 x 260 x 80 mm

Incluye:  
Termómetro  
Chimenea de acero inoxidable c/sombbrero  
Pala de horno telescópico  
Tablero de arcilla 370 x 260 x 80 mm

Comprend :  
Thermomètre  
W/chapeau de cheminée en acier inoxydable  
Pelle à four télescopique  
Argile Conseil 370 x 260 x 80 mm

Forno Exterior a Lenha Maximus  
Horno de Leña Maximus  
Outdoor Wood-Fired Oven Maximus  
Four a Bois Maximus

Ref.		€/Un.
5170.0101		842,85 €
5170.0103		842,85 €

Suporte com Rodas  
Soporte con Ruedas  
Support with Wheels  
Support à Roulettes

Ref.		€/Un.
5170.0111		271,45 €
5170.0113		271,45 €

Altura total com suporte - 1850 mm  
Altura total con soporte - 1850 mm  
Total height with stand - 1850 mm  
Hauteur totale avec support - 1850 mm



# Mangueira e Acessórios de Rega

Manguera y Accesorios de Riego | Hose, Fittings and Irrigation Accessories | Tuyau d'Arrosage et Accessoires d'Irrigation



3 camadas | UV resistente  
3 capas | UV resistente  
3 layers | UV resistant  
3 couches | UV résistant

8401M  
Mangueira Jardim TRI-TOP  
Manguera Jardín TRI-TOP  
Garden Hose TRI-TOP  
Tuyau d'Arrosage TRI-TOP

Ref.		€/Un.	
8401.1005	5/8x15 m	14,00 €	5
8401.1010	5/8x25 m	23,00 €	5
8401.1015	5/8x50 m	46,00 €	5
8401.1110	3/4x25 m	32,00 €	5
8401.1115	3/4x50 m	64,00 €	5
8401.1210	1x25 m	55,00 €	5
8401.1215	1x50 m	110,00 €	5



8401S  
Suporte Mangueira  
Soporte Manguera  
Hose Support  
Support Tuyau

Ref.		€/Un.	
8401.2001	Vrd g/g/b/g	7,00 €	6
8401.2003	Vrd p/p/s/p	6,00 €	6
8401.2011	Inox g/g/b/g	12,50 €	6
8401.2013	Inox p/p/s/p	12,00 €	6



MG8409  
Adaptador Torneira Macho  
Adaptador Grifo Macho  
Male Tap Adapter  
Robinet Adapteur Mâle

Ref.		€/Un.	
8401.0009	3/4	0,48 €	120



MG8403\_4  
Adaptador Torneira Fêmea  
Adaptador Grifo Hembra  
Female Tap Adapter  
Robinet Adapteur Femelle

Ref.		€/Un.	
8401.0003	3/4	0,55 €	120
8401.0004	1	0,62 €	120



MG8413\_4  
Adaptador Torneira Fêmea  
Adaptador Grifo Hembra  
Female Tap Adapter  
Robinet Adapteur Femelle

Ref.		€/Un.	
8401.0013	1/2x3/4	0,70 €	120
8401.0014	3/4x1	0,78 €	120



MG8482  
Programador Rega Automático 2 horas  
Temporizador Riego Automático 2 horas  
2 hour Irrigation Timer  
Programateur Automatique 2 heures

Ref.	€/Un.	
8401.0082	12,77 €	10



MG8416  
Adaptador p/ torneira Y LUXO  
Enlace Hembra Y LUXO  
Female Adaptor Y LUXO  
Adpteur Femelle Y LUXO

Ref.		€/Un.	
8401.0016	3/4"	2,34 €	12



MG8470  
Carro Enrolador c/ Mangueira  
Carro Portamanguera  
Hose Cart  
Chariot Enroleur

Ref.		€/Un.	
8401.0070	1/2" x 30 m	74,47 €	2



MG8472  
Enrolador c/ Mangueira  
Enrollador Portátil  
Hose Reel  
Dévidoir

Ref.		€/Un.	
8401.0072	1/2" x 20 m	38,30 €	2



# Ligações e Acessórios de Rega

Conectores y Accesorios de Riego | Fittings and Irrigation Accessories | Raccords et Accessoires d'Irrigation



**MG8420**  
Ligador Universal LUXO  
Conector Universal LUXO  
Universal Connector LUXO  
Raccord Universel LUXO

Ref.		€/Un.	
8401.0020	1/2x5/8x3/4	1,57 €	24



**MG8422**  
Ligador Universal Stop LUXO  
Conector Universal Stop LUXO  
Universal Connector Stop LUXO  
Raccord Universel Stop LUXO

Ref.		€/Un.	
8401.0022	1/2x5/8x3/4	1,67 €	24



**MG8430**  
Ligador Universal TRI-TOP  
Conector Universal TRI-TOP  
Universal Connector TRI-TOP  
Raccord Universel TRI-TOP

Ref.		€/Un.	
8401.0030	1/2x5/8x3/4	3,39 €	24



**MG8432**  
Ligador Universal Stop TRI-TOP  
Conector Universal Stop TRI-TOP  
Universal Connector Stop TRI-TOP  
Raccord Universel Stop TRI-TOP

Ref.		€/Un.	
8401.0032	1/2x5/8x3/4	3,50 €	24



**MG8435**  
União Mangueira Universal LUXO  
Empalme Manguera Universal LUXO  
Universal Hose Mender LUXO  
Reparateur de Tuyau LUXO

Ref.		€/Un.	
8401.0035	1/2x5/8x3/4	1,27 €	24



**MG8440**  
Agulheta Regulável LUXO  
Lanza Regulable LUXO  
Adjustable Nozzle LUXO  
Lance Régable LUXO

Ref.		€/Un.	
8401.0040		1,72 €	24



**MG8441**  
Agulheta Regulável Stop LUXO  
Lanza Regulable Stop LUXO  
Adjustable Nozzle Stop LUXO  
Lance Réglable Stop LUXO

Ref.		€/Un.	
8401.0041		2,69 €	24



**MG8442**  
Agulheta Regulável TRI-TOP  
Lanza Regulable TRI-TOP  
Adjustable Nozzle TRI-TOP  
Lance Régable TRI-TOP

Ref.		€/Un.	
8401.0042		6,77 €	24



**MG8445**  
Hidropistola Regulável LUXO  
Hidropistola Regulable LUXO  
Adjustable Spray Gun LUXO  
Pistolet Réglable LUXO

Ref.		€/Un.	
8401.0045		4,11 €	24



**MG8447**  
Pistola Aspersão LUXO  
Pistola Aspersión LUXO  
Spray Gun LUXO  
Pistolet LUXO

Ref.		€/Un.	
8401.0047		3,55 €	24



**8025**  
Pistola Rega 8 Funções  
Pistola Riego 8 Funciones  
Sprayer Gun 8 Functions  
Pistolet 8 Fonctions

Ref.		€/Un.	
8025.0100		7,45 €	6



**8026**  
Pistola Jato Metálica  
Pistola Chorro Metálica  
Jet Spray Gun  
Pistolet d'Arrosage

Ref.		€/Un.	
8026.0100		8,51 €	6

# Aspersores e Pulverizadores

Aspersores y pulverizadores | Sprinklers and Sprayers | Arroseurs et Pulvérisateurs



8029  
Aspersor Canhão 1 1/2 c/ Tripé Fixo  
Cañón de riego 1 1/2 c/ Trípode Fijo  
Sprinkler Cannon 1 1/2 w/ Fixed Tripod  
Arroseur Cannon 1 1/2 a/ Trépied Fixe



Ref. **€/Un.**

8029.0025 **135,00 €**

**7 x 8,5**

	1 bar	1,5 bar	2 bar	2,5 bar	3 bar	3,5 bar	4 bar
	4,5 m³/h	5,5 m³/h	6,4 m³/h	7,1 m³/h	7,8 m³/h	8,4 m³/h	9 m³/h
	17,3 m	18,3 m	19 m	19,6 m	20,1 m	20,6 m	21 m

**7 x 11,5**

	1 bar	1,5 bar	2 bar	2,5 bar	3 bar	3,5 bar	4 bar
	6,7 m³/h	8,2 m³/h	9,5 m³/h	10,6 m³/h	11,6 m³/h	12,6 m³/h	13,4 m³/h
	20 m	21 m	22 m	22,7 m	23,3 m	23,8 m	24,2 m

**7 x 12,5**

	1 bar	1,5 bar	2 bar	2,5 bar	3 bar	3,5 bar	4 bar
	7,6 m³/h	9,3 m³/h	10,8 m³/h	12 m³/h	13,2 m³/h	14,2 m³/h	15,2 m³/h
	20,8 m	22 m	22,9 m	23,6 m	24,2 m	24,7 m	25,2 m

**7 x 15**

	1 bar	1,5 bar	2 bar	2,5 bar	3 bar	3,5 bar	4 bar
	10,1 m³/h	12,4 m³/h	14,3 m³/h	16 m³/h	17,6 m³/h	19 m³/h	20,3 m³/h
	22,6 m	24 m	25 m	25,8 m	26,5 m	27 m	27,5 m

**Bico | Boquilla | Nozzle | Buse**

Pequeno	Grandes			
Pequeña	Grandes			
Small	Large			
Petite	Grands			
7 mm	8,5 mm	11,5 mm	12,5 mm	15 mm



MG8460  
Aspersor Circular c/ Espeto  
Aspersor Circular c/ Pincho  
Circular Sprinkler w/ Spike  
Arroseur Rotatif

Ref. **€/Un.**

8401.0060 **2,67 €** 12



MG8462  
Aspersor Oscilante  
Aspersor Oscilante  
Oscilating Sprinkler  
Arroseur Oscillant

Ref. **€/Un.**

8401.0062 **12,60 €** 12



MG8466  
Aspersor Sectorial Metálico  
Aspersor Sectorial Metálico  
Metallic Sectorial Sprinkler  
Arrosage Sectoriel Métallique

Ref. **€/Un.**

8028.0010 1/2 **9,00 €** 12



MG8464  
Aspersor Sectorial ABS  
Aspersor Sectorial ABS  
Sectorial Sprinkler ABS  
Arroseur Sectoriel ABS

Ref. **€/Un.**

8028.0015 1/2 **2,50 €** 12



8050P  
Pulverizador 8 L - Lança Latão  
Pulverizador 8 L - Lanta Latón  
Sprayer 8 L - Brass Lance  
Pulvérisateur 8 L - Lance Laiton

Ref. **€/Un.**

8050.0080 8 L **26,00 €** 1



8028M  
Mochila Pulverizador - Lança Inox  
Mochila Pulverizador - Lanta Inox  
Backpack Sprayer - S. S. Lance  
Pulvérisateur à Pression - Lance Inox

Ref. **€/Un.**

8050.0100 16 L **38,00 €** 1

# Ligações e Acessórios de Rega

Conectores y Accesorios de Riego | Fittings and Irrigation Accessories | Raccords et Accessoires d'Irrigation



**8014**  
Adaptador Torneira Macho  
Adaptador Grifo Macho  
Male Tap Adapter  
Robinet Adapteur Mâle

Ref.		€/Un.	
8014.0103	1/2	<b>1,63 €</b>	24
8014.0104	3/4	<b>1,79 €</b>	24



**8015**  
Adaptador Torneira Fêmea  
Adaptador Grifo Hembra  
Female Tap Adapter  
Robinet Adapteur Femelle

Ref.		€/Un.	
8015.0103	1/2	<b>1,72 €</b>	24
8015.0104	3/4	<b>1,95 €</b>	24
8015.0105	1	<b>2,65 €</b>	24



0317.0107	1/4	<b>2,40 €</b>	24
8015.0114	3/4	<b>2,16 €</b>	24
8015.0115	1	<b>2,62 €</b>	24



**8015R**  
Adaptador Torneira Fêmea  
Adaptador Grifo Hembra  
Female Tap Adapter  
Robinet Adapteur Femelle

Ref.		€/Un.	
8015.0121	1/2x3/4	<b>3,09 €</b>	24
8015.0122	3/4x1	<b>5,50 €</b>	24



**8017**  
União p/ Mangueira  
Empalme Manguera  
Hose Mender  
Reparateur de Tuyau

Ref.		€/Un.	
8017.0103	1/2	<b>3,99 €</b>	24
8017.0104	3/4	<b>6,12 €</b>	24



**8011**  
Adaptador Rápido  
Adaptador Rápido  
Quick Hose Connector  
Raccord Rapide

Ref.		€/Un.	
8016.0103	1/2	<b>5,11 €</b>	24
8016.0104	3/4	<b>6,99 €</b>	24



**8016**  
Adaptador Rápido c/ Stop  
Adaptador Rápido c/ Stop  
Quick Hose Connector w/ Stop  
Raccord Rapide a/ Stop

Ref.		€/Un.	
8016.0113	1/2	<b>5,20 €</b>	24
8016.0114	3/4	<b>7,10 €</b>	24



**MG8468**  
Espeto Metálico  
Pincho Metálico  
Spike  
Pointe Métallique

Ref.		€/Un.	
8028.0020	1/2	<b>2,34 €</b>	12



**8027R**  
Agulheta Regulável  
Lanza Regulable  
Adjustable Nozzle  
Lance Réglable

Ref.	€/Un.	
8027.0100	<b>5,32 €</b>	12



**8027B**  
Agulheta Regulável c/ Borracha  
Lanza Regulable c/ Goma  
Adjustable Nozzle w/ Rubber  
Lance Réglable a/ Caoutchouc

Ref.	€/Un.	
8027.0110	<b>7,45 €</b>	12

# Acessórios de Rega

Accesorios de Riego | Irrigation Accessories | Accessoires d'Irrigation

## Acessórios Acoplamento Rápido

Accesorios de Anclaje Rápido | Quick Coupling Accessories | Accessoires Raccord rapide



### Acoplamento Fêmea

Enlace Hembra  
Female Coupling  
Raccord Femelle

Ref.		€/Un.	
8201.0903	1/2	1,90 €	10
8201.0904	3/4	2,15 €	10
8201.0905	1	2,15 €	10
8201.0906	1 1/4	2,99 €	10
8201.0907	1 1/2	3,60 €	10



### Acoplamento Macho

Enlace Macho  
Male Coupling  
Raccord Mâle

Ref.		€/Un.	
8201.0913	1/2	1,90 €	10
8201.0914	3/4	2,15 €	10
8201.0915	1	2,15 €	10
8201.0916	1 1/4	2,99 €	10
8201.0917	1 1/2	3,60 €	10



### Acoplamento Mangueira

Enlace Manguera  
Hose Coupling  
Raccord Arrosage

Ref.		€/Un.	
8201.0923	1/2	2,00 €	10
8201.0924	3/4	2,36 €	10
8201.0925	1	2,67 €	10
8201.0926	1 1/4	3,60 €	10
8201.0927	1 1/2	4,89 €	10



### Tampão

Tapón  
Plug  
Bouchon

Ref.	€/Un.	
8201.0901	2,11 €	10



### Junta Borracha

Junta Goma  
Rubber Joint  
Caoutchouc

Ref.	€/Un.	
8201.0930	0,35 €	10



Pulverizador PS-04-5SS  
Difusor Emergente PS-04-5SS  
Sprayer PS-04-5SS  
Tuyère PS-04-5SS



Ref.		€/Un.	
8201.0075	1/2	4,08 €	10



Aspersor Turbina 5004E  
Aspersor Turbina 5004E  
Rotor 5004E  
Arroseur 5004E



Ref.		€/Un.	
8201.0206	3/4	18,85 €	20



Pulverizador PS-04  
Difusor Emergente PS-04  
Spray PS-04  
Tuyère PS-04



Ref.		€/Un.	
8201.0100	10	4,20 €	50
8201.0101	12	4,20 €	50
8201.0102	15	4,20 €	50
8201.0103	17	4,20 €	50



Bico Regulável  
Tobera Regulable  
Adjustable Nozzle  
Bus Reglable

Ref.		€/Un.	
8201.0108	10	2,97 €	10
8201.0109	12	2,97 €	10
8201.0110	15	2,97 €	10
8201.0111	17	2,97 €	10



Aspersor Turbina PGP-ADJ  
Aspersor Turbina PGP-ADJ  
Rotor PGP-ADJ  
Arroseur PGP-ADJ



Ref.		€/Un.	
8201.0204	3/4	17,80 €	20



Aspersor Turbina SRM-04  
Aspersor Turbina SRM-04  
Rotor SRM-04  
Arroseur SRM-04



Ref.		€/Un.	
8201.0208	1/2	16,36 €	25



# Acessórios Rega

Accesórios Rego | Irrigation Accessories | Accessoires Irrigation



Controlador ELC  
Programador ELC  
Controller ELC  
Programmateur ELC



Ref.		€/Un.	
8201.0502	4	77,13 €	1
8201.0503	6	92,56 €	1



Controlador XC  
Programador XC  
Controller XC  
Programmateur XC



Ref.		€/Un.	
8201.0511	2	110,00 €	1
8201.0512	4	113,00 €	1
8201.0513	6	130,00 €	1
8201.0514	8	178,90 €	1



Electroválvula PGV100  
Electroválvula PGV100  
Valve PGV100  
Electrovanne PGV100



Ref.		€/Un.	
8201.0304	1 F/F	30,00 €	10
8201.0306	1 M/M	30,00 €	10



Pluviómetro RAIN-CLICK  
Pluviómetro RAIN-CLICK  
Rain Sensor RAIN-CLICK  
Sonde Pluie RAIN-CLICK



Ref.	€/Un.	
8201.0601	77,00 €	1



Joelho Canelado  
Codo  
Elbow  
Coude

Ref.		€/Un.	
8201.1101	16x1/2	0,25 €	100
8201.1102	16x3/4	0,25 €	100



# Electrobombas e Acessórios

Bombas y Accesorios | Pumps and Accessories | Pompes et Accessoires

Água Limpa / Agua Limpia / Clean Water / Eau Douce

Uso / Uso / Use / Utilization



Electrobomba JET100  
Electrobomba JET100  
Self-Priming Pump JET100  
Pompe Centrifuge Auto-Amorçante JET100



Ref.  €/Un.

9906.0100 1HP / 1" 170,21 €

220/230 V - 50 Hz  
Protec: IP44

POWER		Q m <sup>3</sup> /h	0	0.3	0.6	0.9	1.2	1.5	1.8	2.1	2.4	3.0	3.6
KW	HP	l/min	0	5	10	15	20	25	30	35	40	50	60
0.75	1	Hm	45	44	38	31.5	28.5	24	21	18	15.5	11.5	9



## Kits de Pressão JET100

Kits de Presión JET 100

JET100 Pressure Kits

Kits de Pression JET100



Ref.   €/Un.

9906.2105 1HP 24L 255,32 €



Ref.   €/Un.

9906.2110 1HP 24L 255,32 €



Ref.   €/Un.

9906.2111 1HP 24L 287,23 €

# Electrobombas e Acessórios

Bombas y Accesorios | Pumps and Accessories | Pompes et Accessoires



Água Limpa / Agua Limpia / Clean Water / Eau Douce

Uso / Uso / Use / Utilization



Electrobomba JET150  
Electrobomba JET150  
Self-Priming Pump JET150  
Pompe Centrifuge Auto-Amorçante JET150



Ref. €/Un.

9906.0105 1,5HP / 1" **255,32 €**

220/230 V - 50 Hz

Protec: IP44

POWER		Q m <sup>3</sup> /h	0	0.6	0.9	1.2	1.5	1.8	2.1	2.4	2.7	3.0	3.6	4.2	4.8	6.0	7.2	8.4	9.6
KW	HP	l/min	0	10	15	20	25	30	35	40	45	50	60	70	80	100	120	140	160
1.1	1.5	Hm	52	50	48	45	44	42	40	38	38	35	32	31	28	24	20		



Electrobomba Periférica QB  
Electrobomba Periférica QB  
Peripheral Pump QB  
Pompe Périphérique QB



Ref. €/Un.

9906.1006 0,5HP / 1" **67,02 €**

220/230 V - 50 Hz

Protec: IP44

9906.1007 0,8HP / 1" **98,94 €**

POWER		Q m <sup>3</sup> /h	0	0.3	0.6	0.9	1.2	1.5	1.8	2.1	2.4	3.0	3.6	4.2	4.8	5.4
KW	HP	l/min	0	5	10	15	20	25	30	35	40	50	60	70	80	90
0.37	0.50	Hm	40	38	33.5	29	24	19.5	15	10	5					
0.60	0.80		65	62	57	52	47	42	37	32	27	18				



Electrobomba CPM - 158  
Electrobomba Aspiracion CPM - 158  
Suction Pump CPM - 158  
Pompe CPM - 158



Ref. €/Un.

9906.2001 1HP / 1" **191,49 €**

220/230 V - 50 Hz

Protec: IP44

POWER		Q m <sup>3</sup> /h	0	0.6	1.2	1.8	2.4	3.0	3.6	4.2	4.8	5.4
KW	HP	l/min	0	10	20	30	40	50	60	70	80	90
0.75	1	Hm	36	34	33.5	33	32.5	31.5	30	29	27	25

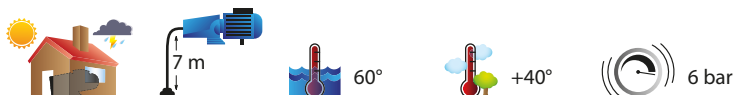

# Electrobombas e Acessórios

Bombas y Accesorios | Pumps and Accessories | Pompes et Accessoires



Água Limpa / Agua Limpia / Clean Water / Eau Douce

Uso / Uso / Use / Utilization



Electrobomba Sucção 2DKM20  
Electrobomba Aspiración 2DKM20  
Suction Pump 2DKM20  
Pump 2DKM20



220/230 V - 50 Hz  
Protec: IP44

Ref.  €/Un.

9906.2005 2 HP / 2" **244,68 €**

POWER		Q m <sup>3</sup> /h	0	6	9	12	15	18	21	24	30	36
KW	HP	l/min	0	100	150	200	250	300	350	400	500	600
1.5	2	Hm	22.5	22	21.5	21	20	18.5	16.6	14.5	10	



## Acessórios

Accesórios | Accessories | Accessoires



9907CM  
Autoclave Chapa c/ Membrana  
Vaso Expansión Chapa c/ Membrana  
Steel Expansion Vessel  
Accumulateur Hydropneumatic Acier

Ref.		Ø	€/Un.
9907.0200	24 L	360	<b>31,91 €</b>
9907.0201	60 L	398	<b>110,64 €</b>
9907.0202	80 L	398	<b>126,60 €</b>
9907.0203	100 L	398	<b>142,55 €</b>
9907.0204	200 L	398	<b>279,79 €</b>



9907IM  
Autoclave Inox c/ Membrana  
Vaso Expansión Inox c/ Membrana  
S.S. Hydropneumatic Tank  
Accumulateur Hydropneumatic Inox

Ref.		Ø	€/Un.
9907.0000	24 L	360	<b>79,79 €</b>
9907.0001	60 L	398	<b>253,19 €</b>
9907.0002	80 L	398	<b>268,09 €</b>
9907.0100	100 L	398	<b>312,77 €</b>
9907.0104	200 L	398	<b>638,30 €</b>



9907CM  
Autoclave Chapa c/ Membrana  
Vaso Expansión Chapa c/ Membrana  
Steel Pressure Tank  
Accumulateur Hydropneumatic Acier

Ref.		Ø	€/Un.
9907.0300	24 L	295	<b>40,43 €</b>
9907.0301	60 L	398	<b>127,66 €</b>



9907CE  
Autoclave Chapa c/ Membrana Especial  
Vaso Expansión Chapa c/ Membrana Especial  
Steel Expansion Vessel Special Membrane  
Accumulateur Hydropneumatic Acier

Ref.		Ø	€/Un.
9907.0211	60 L	398	<b>120,21 €</b>
9907.0213	100 L	398	<b>173,40 €</b>



# Acessórios

Accesórios | Accessories | Accessoires



**9908N**  
Membrana  
Membrana  
Membrane  
Membrane

Ref.		€/Un.	
9907.0500	24 L	9,04 €	1
9907.0505	50-60 L	29,79 €	1
9907.0510	80-100 L	53,19 €	1



**9908E**  
Membrana Especial  
Membrana Especial  
Special Membrane  
Membrane Spécial

Ref.		€/Un.	
9907.0555	60 L	35,00 €	1
9907.0560	100 L	65,00 €	1



**9907PS**  
Pressostato  
Presostato  
Pressure Gauge  
Pressóstato



Ref.	€/Un.	
9907.0600	6,38 €	50



**9907PL**  
Pressostato c/ Porca Louca  
Presostato c/ Racor Louca  
Pressure Gauge w/ Loose Nut  
Pressóstato Écrou Mobile



Ref.	€/Un.	
9907.0605	6,91 €	50



**Controlador de Pressão**  
Controlador de Presión  
Pressure Controller  
Régulateur de Pression



Ref.	€/Un.	
9907.0900	48,94 €	12



**9907IN**  
Interruptor de Nível  
Interruptor de Boya  
Switch Level  
Poire de Niveau



Ref.		€/Un.	
9907.1000	3 m	10,64 €	1
9907.1005	5 m	13,83 €	1
9907.1010	8 m	18,09 €	1



**9907CC**  
Condensador  
Condensador  
Capacitor  
Condenseur

Ref.		€/Un.	
9907.1020	12,5 Uf	2,87 €	1
9907.1021	20 Uf	4,04 €	1
9907.1022	25 Uf	4,36 €	1
9907.1023	30 Uf	4,84 €	1
9907.1024	40 Uf	5,32 €	1
9907.1025	50 Uf	6,65 €	1
9907.1026	60 Uf	9,57 €	1



**9907CC**  
Condensador Clip  
Condensador Clip  
Capacitor Clip  
Condenseur Clip

Ref.		€/Un.	
9907.1030	8 Uf	3,19 €	1
9907.1031	10 Uf	3,83 €	1
9907.1032	12,5 Uf	4,15 €	1
9907.1033	16 Uf	4,26 €	1
9907.1034	20 Uf	5,21 €	1



**9908SQ**  
Kit 3 Sondas p/ Quadro Eléctrico  
Kit 3 Sondas p/ Cuadro Eléctrico  
Kit 3 Probes f/ Switchboard  
Kit 3 Sonders p/ Panneau Électrique

Ref.	€/Un.	
9908.1000	8,50 €	5



**9908KE**  
Kit Emenda Calor c/ 4 Uniões  
Kit 4 Empalmes Termoretráctil  
Thermo-Shrink Ammdement  
Kit 4 Jonctions Thermorétractable

Ref.	€/Un.	
9908.1100	3,60 €	5

# Acessórios

Accesórios | Accessories | Accessoires



**9909 GV**  
**Manómetro Glicerina Vertical 1/4"**  
 Manómetro Glicerina Vertical 1/4"  
 Vertical Glycerine Manometer  
 Manomètre Glycérine Vertical

Ref.			€/Un.	
9909.0001	0-10 bar	Ø 63	<b>12,00 €</b>	1
9909.0002	0-16 bar	Ø 63	<b>12,00 €</b>	1



**9909GF**  
**Manómetro Glicerina Frontal 1/4"**  
 Manómetro Glicerina Frontal 1/4"  
 Front Glycerine Manometer  
 Manomètre Glycerine Avant

Ref.			€/Un.	
9909.0011	0-10 bar	Ø 63	<b>13,15 €</b>	1
9909.0012	0-16 bar	Ø 63	<b>13,15 €</b>	1
9909.0013	0-25 bar	Ø 63	<b>13,15 €</b>	1



**9909V**  
**Manómetro Vertical 1/4"**  
 Manómetro Vertical 1/4"  
 Vertical Pressure Gauge 1/4"  
 Manomètre Radial 1/4"



Ref.			€/Un.	
9909.0101	0-10 bar	Ø 63	<b>3,80 €</b>	50



**9907F**  
**Manómetro Frontal 1/4"**  
 Manómetro Frontal 1/4"  
 Front Manometer 1/4"  
 Manomètre Avant 1/4"

Ref.			€/Un.	
9909.0111	0-10 bar	Ø 63	<b>3,80 €</b>	50



**9907CRI**  
**Canhão Roscado Inox**  
 Cañón Roscado Inox  
 Threaded Pipe S. S.  
 Racor Filetage Inox



Ref.		€/Un.	
9907.0705	1	<b>14,89 €</b>	1
9907.0706	11/4	<b>18,09 €</b>	1
9907.0707	11/2	<b>21,01 €</b>	1
9907.0708	2	<b>27,13 €</b>	1
9907.0709	21/2	<b>32,45 €</b>	1
9907.0710	3	<b>39,89 €</b>	1



**9907CRE**  
**Canhão Rosca / Estria Inox**  
 Cañón Rosca / Estria  
 Pipe Thread / Rib S. S.  
 Racor Filete / Nervure Inox



Ref.		€/Un.	
9907.1705	1	<b>15,00 €</b>	1
9907.1706	11/4	<b>17,00 €</b>	1
9907.1707	11/2	<b>19,75 €</b>	1
9907.1708	2	<b>25,50 €</b>	1
9907.1709	21/2	<b>30,50 €</b>	1
9907.1710	3	<b>37,50 €</b>	1



**9907TF**  
**Tapa Furo c/ Casquilho**  
 Tapa Pozo Barrena c/ Macho  
 Dug Well Cap c/ Male  
 Couverture Bien a/ Mamelon



Ref.		€/Un.	
9907.0405	1	<b>38,83 €</b>	1
9907.0406	11/4	<b>40,43 €</b>	1
9907.0407	11/2	<b>41,91 €</b>	1
9907.0408	2	<b>47,34 €</b>	1



**9907KJ**  
**Kit Junção p/ Circuladora**  
 Kit Racor p/ Circuladora  
 Circulating Pump Joint Kit  
 Connexion Pompe Kit

Ref.		€/Un.	
9907.0800	1	<b>7,45 €</b>	5



**9907VA**  
**Válvula Água**  
 Válvula Agua  
 Water Valve  
 Soupape Eau



Ref.		€/Un.	
9907.0725	1/2	<b>5,05 €</b>	40



**9907VI**  
**Válvula Ar**  
 Válvula Air  
 Air Valve  
 Soupape Air





Ref.		€/Un.	
9907.0720	1/2	<b>5,05 €</b>	40

# Acessórios

Accesórios | Accessories | Accessoires



9907JS  
Junção c/ Retenção p/ Circuladora  
Racor c/ Retención p/ Circuladora  
Pump Isolating Joint  
Connexion Pompe a/ Rétention

Ref.		€/Un.	
9907.0810	1	10,11 €	10





611  
Tê 5 Vias  
Te 5 Vias  
5 Ways Tee  
Te 5 Voies

Ref.		€/Un.	
0611.0000	normal	5,59 €	5
0611.0002	comprido	7,21 €	5





611F  
Tê 3 Vias  
Te 3 Vias  
3 Ways Tee  
Te 3 Voies

Ref.		€/Un.	
0611.0502	1/4 x 1/2 40	4,20 €	10



612  
Tê 3 Vias Macho  
Te 3 Vias Macho  
3 Ways Tee Male  
Te 3 Voies Mâle

Ref.		€/Un.	
0612.0101	1/4 x 1/4 x 1/2	1,35 €	10

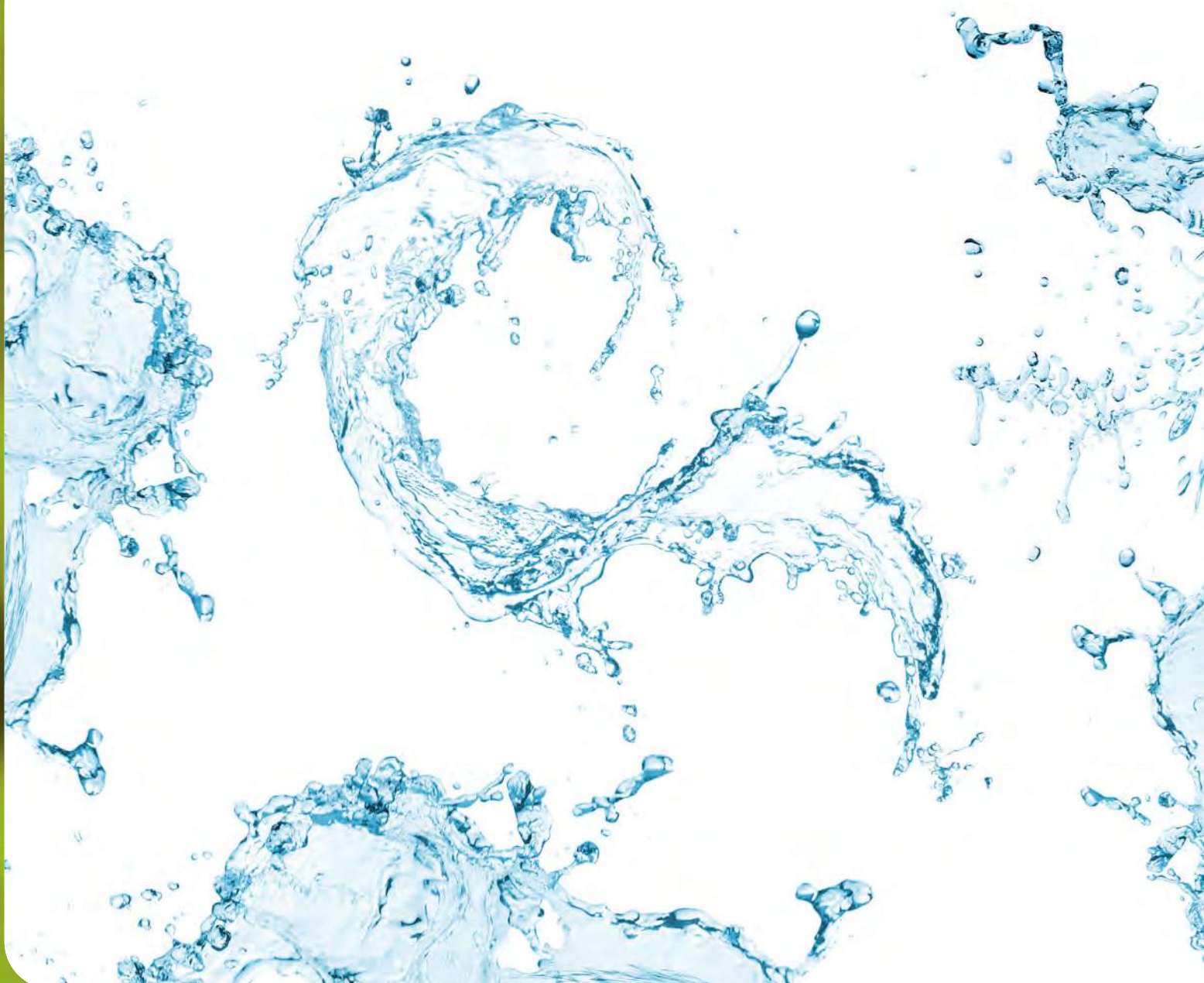



# 7

Incêndio  
Fuego | Fire | Incendie



Ø Agulheta Mangueira | Ø Lanza Manguera  
Ø Hose Nozzle | Ø Bec Tuyau



Ø Tubo Mangueira | Ø Tubo Manguera | Ø Hose | Ø Tuyau



Contacte-nos | Contáctenos | Contact us | Contactez-nous



Medida/Cor | Medida/Color  
Size/Colour | Mesure/Couleur





# Material Contra-Incêndio

Material Contra-Incendio | Fire Equipment | Equipments d'Incendie





**798ST**  
Caixa de Incêndio Standard  
Boca Incendio Standard  
Fire Hose Cabinet  
Bouché d'Incendie Standard

Ref.		€/Un.	
0798.0211	20 m	<b>254,00 €</b>	1
0798.0213	25 m	<b>271,00 €</b>	1

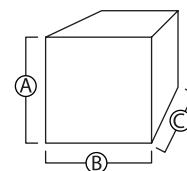
A - 480 mm  
B - 625 mm  
C - 140 mm





**798CR**  
Caixa Carretel  
Boca Incendio Equipada  
Fire Hose Reel Cabinet  
Bouché D'Incendie Equipéé

Ref.		€/Un.	
0798.0810	20 m	<b>350,00 €</b>	1
0798.0815	25m	<b>375,00 €</b>	1

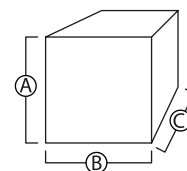
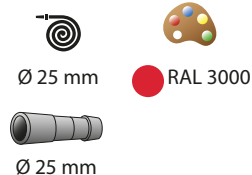
A - 650 mm  
B - 680 mm  
C - 220 mm



**796CP**  
Caixa Incêndio Carretel PLUS  
Boca Incendio Equipada PLUS  
Fire Hose Reel Cabinet PLUS  
Bouché D'Incendie Equipéé PLUS

Ref.		€/Un.	
0796.0901	20 m	<b>335,00 €</b>	1
0796.0902	25 m	<b>355,00 €</b>	1

A - 650 mm  
B - 680 mm  
C - 180 mm

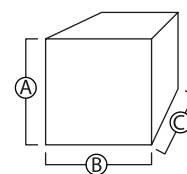
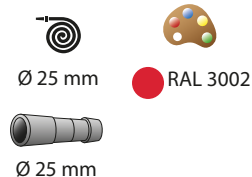

**798TC**  
Caixa p/ Válvula Tipo Candeia  
Boca Incendio p/ Válvula Asiento  
Valve Fire Hose Cabinet  
Bouché d'Incendie p/ Vanne

Ref.	€/Un.	
0798.0860	<b>41,43 €</b>	1

A - 300 mm  
B - 300 mm  
C - 220 mm

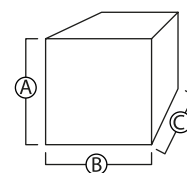

**798MI**  
Marco Incêndio  
Boca de Incendio  
Fire Hydrant  
Bouché d'Incendie

Ref.	€/Un.	
0798.0602		1



**796AI**  
Aguilheta  
Lanza  
Nozzle  
Bec



Ref.		€/Un.	
0796.1235	25 mm	<b>21,50 €</b>	1
0796.1240	45 mm	<b>22,50 €</b>	1

# Material Contra-Incêndio

Material Contra-Incendio | Fire Equipment | Equipments d'Incendie



**798BI**  
Boca de Incêndio  
Boca Incendio  
Fire Valve  
Vanne Feu

Ref.		€/Un.	
0798.0101	1 1/2"	<b>35,00 €</b>	1



**798BC**  
Boca de Incêndio T/C  
Boca Incendio T/C  
Fire Valve T/C  
Vanne Feu T/C

Ref.		€/Un.	
0798.0103	2"x45	<b>36,66 €</b>	1



**798BL**  
Boca de Incêndio T/Lisboa  
Boca Incendio T/Lisboa  
Fire Valve T/Lisboa  
Vanne Feu T/Lisboa

Ref.		€/Un.	
0798.0104	1 1/2"x45	<b>89,14 €</b>	1



**676JD**  
Junção Dupla  
Entronque Hembra  
Double Hose Connector  
Manchon Double Arrosage

Ref.		€/Un.	
0676.0007	1 1/2"x45	<b>11,89 €</b>	1



**676MJF**  
Meia Junção Fêmea  
Entronque Hembra  
Female Hose Connector  
Manchon Arrosage F

Ref.		€/Un.	
0676.0008	1 1/2"x45	<b>11,00 €</b>	1



**676MJM**  
Meia Junção Macho  
Entronque Macho  
Male Hose Connector  
Manchon Arrosage M

Ref.		€/Un.	
0676.0010	1 1/2"x45	<b>9,09 €</b>	1



**798AS**  
Adaptador STORZ  
Racor STORZ  
STORZ Coupler  
Raccord STORZ

Ref.		€/Un.	
0798.2010	52 mm	<b>11,89 €</b>	1



**798TB**  
Tampão p/ Boca Incêndio  
Tapón  
Stopper  
Bouchon

Ref.		€/Un.	
0798.0501		<b>10,85 €</b>	1



# 8.0

## Outras Marcas e Informações Adicionais

Otras Marcas e Información Adicional | Other Brands and Additional Info | Autres Marques et Informations Supplémentaires





# Outras Marcas Representadas

Otras Marcas Representadas | Other Brands Represented | Autres Marques Représentées



## Chuveiros

Duchas | Hand Showers | Douches



## Rampas e Chuveiros

Barras Ducha | Shower Sets | Rampes Douches



## Ligações

Flexos | Shower Hoses | Flexible Douche



## Varões

Barras de Cortina | Curtain Rods | Rideau Rods



## Acessórios Casa de Banho

Menaje | Wosehold Wave | Ménage



## Solicite Preço

Solicitar Lista de Precios

Ask for Price List

Requête Liste des Prix

# Outras Marcas Representadas

Otras Marcas Representadas | Other Brands Represented | Autres Marques Représentées



**Fucoli - Somepal**  
FUNDIÇÃO DE FERRO, S.A.

## Válvulas

Válvulas | Valves | Vannes



## Ventosas

Ventosas | Air Valves | Vannes d'Air



## Incêndio

Incendio | Fire Equipment | Équipement de Feu



## Braçadeiras e Juntas

Abrazaderas y Juntas | Saddles and Conplings | Selles et Accomplements



## Flanges e Acessórios

Bridas y Accesorios | Flanges and Accessories | Brides et Accessoires



## Tampas e Grelhas

Tapas y Rejillas | Manhole Covers and Grates | Plaques D'Égout et Grilles



## Solicite Preço

Solicitar Lista de Precios

Ask for Price List

Requête Liste des Prix

# Outras Marcas Representadas

Otras Marcas Representadas | Other Brands Represented | Autres Marques Représentées



## POLITEJO

### Tubos e Acessórios PVC

Tubos y Accesorios PVC  
PVC Pipes and Fittings  
Tube et Accessoires PVC



### Tubo PEAD

Tubo PEAD  
PEAD Pipe  
Tube PEAD

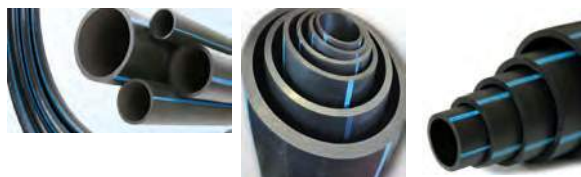

### Tubo AMBIDUR

Tubo AMBIDUR (PP)  
AMBIDUR Pipe (PP)  
Awbe AMBIDUR (PP)

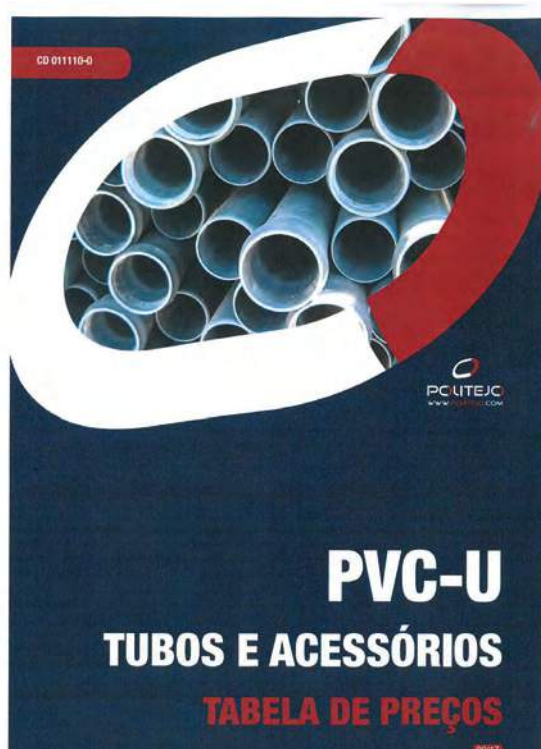

### Solicite Preço

Solicitar Lista de Precios  
Ask for Price List  
Requête Liste des Prix



# 8.1

## Certificados e Condições de Venda

Certificados y Condiciones de Venta | Certificates and Sales Conditions | Certificats et Conditions de Vente







Certificado  
Certificate

NÚMERO 2003/CEP.1956  
Number

O Sistema de Gestão da Qualidade da  
*The Quality Management System of*

**MEBRA – COMÉRCIO POR GROSSO DE METAIS E ACESSÓRIOS DE BRAGA, S.A.**

Lugar do Barreiro  
4734-908 VILA DE PRADO  
PORTUGAL

implementado na comercialização de componentes e acessórios para a indústria de construção, cumpre os requisitos da norma  
*Implemented in the commercialization of components and accessories for building industry, meets the requirements of the standard*

**NP EN ISO 9001:2008**



José Leitão  
CEO

Emitido em 2015-04-28  
*Date of issue*  
Válido até 2018-04-27  
*Valid until*

APCER - Associação Portuguesa de Certificação  
Edifício de Serviços da Emenor, 2º Andar, Av. Dr. António Macedo  
4450-617 Leça da Palmeira  
www.apcer.pt





THE INTERNATIONAL CERTIFICATION NETWORK

# CERTIFICATE

IQNet and

APCER

hereby certify that the organization

**MEBRA – COMÉRCIO POR GROSSO DE METAIS E ACESSÓRIOS DE BRAGA, S.A.**

Lugar do Barreiro  
4734-908 VILA DE PRADO  
PORTUGAL

for the following field of activities

Commercialization of components and accessories for building industry

has implemented and maintains a

**Quality Management System**

Which fulfils the requirements of the following standard

**ISO 9001:2008**

Issued on: 2015-04-28

Validity date: 2018-04-27

*Registration Number:* PT- 2003/CEP.1956



*Michael Drechsel*  
President of IQNet

*José Leitão*  
APCER CEO



Any additional clarification concerning the scope of this certificate may be obtained by consulting APCER.

**IQNet Partners\*:**

AENOR Spain AFNOR Certification France AIB-Vinçotte International Belgium ANCE-SIGE Mexico APCER Portugal CCC Cyprus  
CISQ Italy CQC China CQM China CQS Czech Republic Cro Cert Croatia DQS Holding GmbH Germany  
FCAV Brazil FONDONORMA Venezuela ICONTEC Colombia IMNC Mexico Inspecta Certification Finland IRAM Argentina  
JQA Japan KFQ Korea MIRTEC Greece MSZT Hungary Nemko AS Norway NSAI Ireland PCBC Poland  
Quality Austria Austria RR Russia SII Israel SIQ Slovenia SIRIM QAS International Malaysia  
SQS Switzerland SRAC Romania TEST St Petersburg Russia TSE Turkey YUQS Serbia  
IQNet is represented in the USA by: AFNOR Certification, CISQ, DQS Holding GmbH and NSAI Inc.

\* The list of IQNet partners is valid at the time of issue of this certificate. Updated information is available under [www.iqnet-certification.com](http://www.iqnet-certification.com)



# Certificado de Conformidade

## Certificate of Registration

NÚMERO 2013/SST.0359  
*Number*

**APCER – Associação Portuguesa de Certificação** certifica que o Sistema de Gestão da Segurança e Saúde do Trabalho da APCER – Associação Portuguesa de Certificação certifies that the *Occupational Health and Safety Management System of*

### **MEBRA – Comércio por Grosso de Metais e Acessórios de Braga, S.A.**

Lugar do Barreiro  
4734-908 VILA DE PRADO  
PORTUGAL

implementado na comercialização de componentes e acessórios para a indústria de construção, cumpre os requisitos da norma  
*implemented in the wholesaler for building industry components and accessories, meets the requirements of the standard*

### **OHSAS 18001:2007 / NP 4397:2008**

**Occupational Health and Safety Management Systems – Requirements / Sistemas de Gestão da Segurança e Saúde do Trabalho – Requisitos**

Data de emissão 2013-05-06  
*Date of issue*

José Leitão  
CEO

Válido até 2016-05-05  
*Valid until*

Qualquer esclarecimento adicional sobre este certificado pode obter-se consultando a APCER

*Any additional clarification concerning this certificate may be obtained by consulting APCER*

APCER – Associação Portuguesa de Certificação  
Edifício de Serviços da Exponor, 2º Andar, Av. Dr. António Macedo  
4450-617 Leça da Palmeira

[www.apcer.pt](http://www.apcer.pt)

APCER parceiro da





®



THE INTERNATIONAL CERTIFICATION NETWORK

# CERTIFICATE

IQNet and

APCER

hereby certify that the organization

**MEBRA – Comércio por Grosso de Metais e Acessórios de Braga, S.A.**

Lugar do Barreiro  
4734-908 VILA DE PRADO  
PORTUGAL

for the following field of activities

Wholesaler for building industry components and accessories

has implemented and maintains a

**Occupational Health and Safety Management System**

Which fulfils the requirements of the following standard

**OHSAS 18001:2007**

Issued on: 2013-05-06

Validity date: 2016-05-05

*Registration Number: PT- 2013/SST.0359*

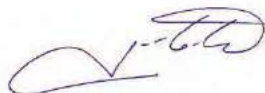
Michael Drechsel  
President of IQNet

José Leitão  
APCER CEO



Any additional clarification concerning the scope of this certificate may be obtained by consulting APCER.

**IQNet Partners\*:**

AENOR Spain AFNOR Certification France AIB-Vinçotte International Belgium ANCE-SIGE Mexico APCER Portugal CCC Cyprus  
CISQ Italy CQC China CQM China CQS Czech Republic Cro Cert Croatia DQS Holding GmbH Germany DS Denmark  
FCAV Brazil FONDONORMA Venezuela ICONTEC Colombia IMNC Mexico INNORPI Tunisia  
Inspecta Certification Finland IRAM Argentina JQA Japan KFQ Korea MIRTEC Greece MSZT Hungary Nemko AS Norway  
NSAI Ireland PCBC Poland Quality Austria Austria RR Russia SII Israel SIQ Slovenia SIRIM QAS International Malaysia  
SQS Switzerland SRAC Romania TEST St Petersburg Russia TSE Turkey YUQS Serbia

IQNet is represented in the USA by: AFNOR Certification, CISQ, DQS Holding GmbH and NSAI Inc.

\* The list of IQNet partners is valid at the time of issue of this certificate. Updated information is available under [www.iqnet-certification.com](http://www.iqnet-certification.com)



# Certificado do Sistema de Gestão da Qualidade



ER-0852/2003

AENOR, Associação Espanhola de Normalização e Certificação certifica que a organização

## MEBRA - Comércio por Grosso de Metais e Acessórios de Braga, S.A.

dispõe de um sistema de Gestão da qualidade conforme com a norma ISO 9001:2008

para as atividades: Comercialização de componentes e acessórios para a indústria de construção.

que se realizam em: LUGAR DO BARREIRO. - 4734-908 VILA DE PRADO (Portugal)

Data da primeira emissão: 2003-06-09  
Data da última emissão: 2015-04-27  
Data de validade: 2018-04-27

The AENOR logo is displayed in blue. It features the word 'AENOR' in a bold, sans-serif font. To the right of 'AENOR', the text 'Asociación Española de Normalización y Certificación' is written in a smaller, sans-serif font. A large, stylized blue signature is written over the logo.

Avelino BRITO  
Director Geral da AENOR

**AENOR**

Asociación Española de  
Normalización y Certificación

Génova, 6. 28004 Madrid. España  
Tel. 902 102 201 - www.aenor.es

AENOR INTERNACIONAL Génova, 6. 28004 Madrid. España - www.aenorinternacional.com



AENOR é membro da REDE IQNet ( Rede Internacional de Certificação)



THE INTERNATIONAL CERTIFICATION NETWORK

# CERTIFICATE

IQNet and  
AENOR  
hereby certify that the organization

**MEBRA - Comércio por Grosso de Metais e Acessórios de Braga, S.A.**

LUGAR DO BARREIRO.  
4734-908 VILA DE PRADO  
Portugal

for the following field of activities

Comercialization of components and accessories for building industries.

has implemented and maintains a

**Quality Management System**

which fulfills the requirements of the following standard

**ISO 9001:2008**

First issued on: 2003-06-09

Last issued: 2015-04-27

Validity date: 2018-04-27

*Registration Number: ES-0852/2003*



*Michael Drechsel*  
President of IQNet

*Avelino BRITO*  
Chief Executive Officer

**AENOR** Asociación Española de Normalización y Certificación

**IQNet Partners\*:**

AENOR Spain AFNOR Certification France AIB-Vinçotte International Belgium ANCE Mexico APCER Portugal CCC Cyprus  
CISQ Italy CQC China CQM China CQS Czech Republic Cro Cert Croatia DQS Holding GmbH Germany  
FCAV Brazil FONDONORMA Venezuela ICONTEC Colombia IMNC Mexico Inspecta Certification Finland IRAM Argentina  
JQA Japan KFQ Korea MIRTEC Greece MSZT Hungary Nemko AS Norway NSAI Ireland PCBC Poland  
Quality Austria Austria RR Russia SII Israel SIQ Slovenia SIRIM QAS International Malaysia  
SQS Switzerland SRAC Romania TEST St Petersburg Russia TSE Turkey YUQS Serbia  
IQNet is represented in the USA by: AFNOR Certification, CISQ, DQS Holding GmbH and NSAI Inc.

\* The list of IQNet partners is valid at the time of issue of this certificate. Updated information is available under [www.iqnet-certification.com](http://www.iqnet-certification.com)

# Condições Gerais de Venda

## PREÇOS

Os preços constantes deste Preçário, apresentados em euros, consideram-se PVP recomendados.

Estes podem ser alterados sem aviso prévio, sendo no entanto respeitados os pedidos em carteira.

Os preços não incluem IVA.

## EXPEDIÇÃO

Para encomendas de valor inferior a 100,00€ acrescem custos de transporte.

Para Exportação: custos de transporte a combinar.

## RESERVA DE PROPRIEDADE

Os artigos fornecidos são propriedade da Mebra S.A. até efetivado o seu pagamento.

## ANULAÇÃO DE ENCOMENDAS

Não será aceite a anulação de encomendas de produtos cujo processo tenha um tratamento único e diferenciado (produtos específicos e não constantes deste preçário).

## DEVOLUÇÕES

Toda e qualquer devolução está sujeita à nossa prévia aceitação.

## RECLAMAÇÕES

As reclamações originadas por divergências entre o encomendado e o fornecido só serão aceites se comunicadas no período de 8 dias a partir da receção da mercadoria.

## CONDIÇÕES DE ENTREGA

Os pedidos poderão ser fornecidos em parte, sem que se suponha a sua anulação.

Neste caso, o cliente deverá informar a não aceitação de entregas parciais. Isentamo-nos de quaisquer responsabilidades relativamente a entregas efetuadas por transportes alheios que não tenham sido devidamente inspeccionadas no ato da entrega.

## GARANTIA

A garantia dos nossos materiais fica limitada à reposição do produto, modelo ou peça que seja por nós reconhecida como defeituosa.

A sua extensão ao curso do seguro de responsabilidade civil, como forma de cobertura de danos a Terceiros, pressupõe o respeito das especificações e prescrições no uso correto dos produtos nomeadamente na sua instalação.

## UTILIZAÇÃO INDEVIDA

Qualquer utilização dos nossos materiais para fins distintos daqueles para que foram produzidos, isentará a nossa Empresa de qualquer tipo de responsabilidade.

## COMPETÊNCIA JUDICIAL

Em caso de litígio resultante de transações comerciais realizadas, submetem-se os nossos clientes à jurisdição da Comarca de Braga

## LIMITAÇÕES

Fica PROIBIDA a reprodução total ou parcial deste preçário.

## NOTA

Os dados fornecidos neste Preçário, como resultado da melhoria contínua e desenvolvimento dos nossos produtos, estão sujeitos a alterações sem aviso prévio.

Este Preçário não é contratual e todas as informações são prestadas de boa fé.

**A versão mais atual deste Preçário está disponível em [www.mebra.pt](http://www.mebra.pt)**

# Condiciones Generales de Venta

## PRECIOS

Los precios incluidos en esta lista de precios, se presentan en euros, son precios recomendados PVP.

Estos pueden ser modificados sin previo aviso, sin embargo, se respetarán los pedidos confirmados anteriormente.

Los precios no incluyen IVA

## ENVÍOS

Para pedidos inferiores a 100 €, se sumarán los gastos de transporte.

Para exportación: el coste de transporte será acordado.

## RESERVA DE PROPIEDAD

Los artículos entregados son propiedad de MEBRA, S.A. hasta que se haya realizado el pago de los mismos.

## CANCELACIÓN DE PEDIDOS

No se aceptará la cancelación de pedidos para los productos cuyo proceso tiene un tratamiento único y diferenciado (productos específicos y otros no incluidos en esta tarifa).

## DEVOLUCIONES

Cualquier devolución está sujeta a la aceptación previa por parte MEBRA, S.A.

## RECLAMACIONES

Sólo se aceptarán reclamaciones originadas por las diferencias entre cantidades pedidas y entregadas si se hace dentro de los 8 días de la recepción de la mercancía.

## CONDICIONES DE ENTREGA

Los pedidos pueden ser procesados parcialmente sin asumir su cancelación. En este caso, el cliente debe notificar la no aceptación de las entregas parciales.

No aceptamos ninguna responsabilidad por las entregas realizadas por otros transportes que no hayan sido inspeccionados correctamente a la entrega.

## GARANTÍA

La garantía de nuestros materiales se limita a la sustitución del producto, modelo o pieza que sea reconocido por nosotros como defectuoso.

Su extensión al seguro de responsabilidad civil de los recursos como una forma de cubrir los daños a terceros, exige el cumplimiento de las especificaciones y requisitos para el uso adecuado de los productos específicos en su instalación.

## UTILIZACIÓN INADECUADA

Cualquier uso de nuestros materiales para fines distintos de aquellos para los que fueron desarrollados, exime a la empresa de toda responsabilidad.

## JURISDICCIÓN

En caso de litigio derivado de transacciones comerciales, las partes se someten al tribunal del distrito de Braga.

## LIMITACIONES

Queda terminantemente prohibida la reproducción total o parcial de esta tarifa.

## OBSERVACIONES

Los datos proporcionados en esta tarifa, debido a la mejora y el desarrollo continuo de nuestros productos están sujetos a cambios sin previo aviso.

Esta lista de precios no es contractual y toda la información se da de buena fe.

La última versión de esta lista de precios está disponible en [www.mebra.pt](http://www.mebra.pt)

# General Sales Conditions

## PRICES

The prices included in this price list, presented in EUR, are recommended prices.  
These can be changed without prior notice, however they will be respected for previously confirmed orders.  
Prices do not include VAT

## SHIPPING

For orders under 100 €, transportation costs will be added.  
For export: transport cost will be arranged.

## OWNERSHIP RESERVATION

Articles delivered are the property of MEBRA, S.A. until payment is cleared.

## CANCELLATION OF ORDERS

Will not be accepted the cancellation of orders for those products whose process has a unique and differentiated treatment (specific products and others not included in this price list)

## RETURNS

All returns are subject to prior acceptance by MEBRA, S.A.

## COMPLAINTS

Complaints arising from differences between the quantities ordered and delivered will only be accepted if made within 8 days of reception of the goods.

## DELIVERY CONDITIONS

Orders may be processed partially without assuming its cancellation.  
In this case, the customer must notify the non-acceptance of partial deliveries.  
We accept no liability for deliveries made by other transports that have not been properly inspected upon delivery.

## WARRANTY

The guarantee of our materials is limited to replacement of the product, model or part that is recognized by us as defective.  
Its extension to the liability insurance of resources as a way to cover the damage to third parties, requires compliance with the specifications and requirements for proper use of specific products in its installation.

## IMPROPER UTILIZATION

Any use of our materials for purposes other than those for which they were produced exempt our company from all liability.

## JURISDICTION

In case of disputes arising from commercial transactions, the jurisdiction applied is the one in the district of Braga.

## LIMITATIONS

The total or partial reproduction of this price list is prohibited.

## REMARKS

The data provided in this price list, due to the continuous improvement and development of our product's is subject to change without notice.  
This price list is not contractual and all information is given in good faith.  
The latest version of this price list is available at [www.mebra.pt](http://www.mebra.pt)

# Conditions Générales de Vente

## PRIX

Les prix inclus dans la liste présentée en EUR, sont PVP recommandés.  
Ceux-ci peuvent être modifiés sans préavis. Les demandes sont respectés dans le portefeuille.  
Les prix ne incluent pas la TVA.

## EXPÉDITION

Pour les commandes de moins de € 100,00 ajouté les coûts de transport .  
Pour exporter : les frais de transport de combiner.

## RESERVE DE PROPRIETE

Articles fournis sont la propriété de Mebra, SA effectuée jusqu'à ce que votre paiement.

## ANNULATION DES COMMANDES

Il ne sera pas accepté l'annulation de commandes pour les produits qui processus a un traitement unique et différenciée ( produits spécifiques et non inclus dans cette liste de prix).

## RETOURS

Tout retour est soumise à notre acceptation préalable .

## PLAINTES

Les plaintes résultant des différences entre les quantités ordonné et fourni ne seront acceptées que si elles sont faites dans les 8 jours de la réception de la marchandise.

## CONDITIONS DE LIVRAISON

Les demandes peuvent être fournis en partie sans supposer son annulation.  
Dans ce cas, le client doit informer la non-acceptation de livraisons partielles.  
Nous déclinons toute responsabilité pour les livraisons faites par les transports autres qui ne ont pas été correctement inspectées lors de la livraison.

## ENTIERCEMENT

La garantie de notre matériaux est limitée au remplacement du produit, le modèle ou le cadre qui est reconnue par nous défectueuse.  
Son extension à l'assurance de responsabilité des ressources comme un moyen de les dommages Troisième couverture, exige le respect des spécifications et exigences pour une bonne utilisation des produits en particulier dans son installation.

## UTILIZATION INAPPROPRIÉE

Toute utilisation de nos matériaux à des fins autres que celles pour lesquelles illes ont été produit, libérer notre société de toute responsabilité.

## COMPÉTENCE

En cas de litige découlant de transactions commerciales, subissant nos clients la juridiction du district de Braga.

## LIMITATIONS

Il est interdit la reproduction totale ou partielle de cette liste de prix.

## REMARQUE

Les données fournies dans cette liste de prix, en raison de l'amélioration et le développement de nos produits continue, sont sujets à changement sans préavis.  
Cette liste de prix ne est pas contractuel et toutes les informations sont données de bonne foi.  
La version la plus récente de cette liste de prix est disponible en [www.mebra.pt](http://www.mebra.pt)









**mebra.pt**

Lugar do Barreiro, Apartado nº 4  
4734-908 Vila de Prado  
Vila Verde - Portugal

Tel: +351 253 929 600

Fax: +351 253 929 611

Tlm: +351 965 916 900

E-mail: [comercial@mebra.pt](mailto:comercial@mebra.pt)



**MEBRA®**

