



CONNECTED TO INNOVATION



Enchufes rápidos de seguridad (aire comprimido)



Enchufes rápidos de seguridad prevoS_i	5 - 18
Enchufes rápidos estándar metálicos	19 - 21
Enchufes rápidos de seguridad prevoS	22 - 24

ENCHUFES RÁPIDOS DE SEGURIDAD PREVO S1 - ISI 06



Enchufe rosca hembra cilíndrica

T1

Rosca hembra BSPP	Referencia	Emba.
G 1/4	ISI 061101	10
G 3/8	ISI 061102	10
G 1/2	ISI 061103	10



ENCHUFES RÁPIDOS DE SEGURIDAD PREVO S1 - ISI 06



Enchufe rotativo rosca macho cilíndrico con junta de impermeabilidad

T1

Rosca macho BSPP	Referencia	Emba.
G 1/2	ISI 061153SE	1

Rotación sobre un eje a 360 °
Cuerpo del codo en aluminio anodizado negro



Enchufe rosca macho cilíndrico con junta

T1

Rosca macho BSPP	Referencia	Emba.
G 1/4	ISI 061151	10
G 3/8	ISI 061152	10
G 1/2	ISI 061153	10



Enchufe pasatabiques

T1

Rosca hembra BSPP	Ø de taladrado (mm)	Espesor del tabique (mm)	Referencia	Emba.
G 1/4	27	11	ISI 062101	1



Enchufe para tubo

T1

Para tubo Ø int. (mm)	Referencia	Emba.
6	ISI 061806	10
8	ISI 061808	10
10	ISI 061810	10
13	ISI 061813	10



Distribuidor fijo de 2 direcciones rosca hembra cilíndrica

T1

Rosca hembra BSPP	Referencia	Emba.
G 1/4	ISI 068101	1
G 3/8	ISI 068102	1
G 1/2	ISI 068103	1



Enchufe orientable rosca hembra cilíndrica

T1

Rosca hembra BSPP	Referencia	Emba.
G 3/8	ISI 061102SW	1

Enlace orientable roscado
Rotación sobre 2 ejes a 360°



Distribuidor fijo de 2 direcciones rosca macho cónico

T1

Rosca macho BSPT	Referencia	Emba.
R 1/4	ISI 068151	1
R 3/8	ISI 068152	1
R 1/2	ISI 068153	1



ENCHUFES RÁPIDOS DE SEGURIDAD PREVO S1 - ISI 06



Aplique mural rosca hembra - 1 enchufe y purga - Perfil ISO 6150 B - Paso 6 mm

T1

Entrada rosca hembra BSPP	Salida : 1 enchufe	Referencia	Emba.
G 1/2	ISI 06	ISI 061103WK	1



Aplique mural rosca hembra - 2 enchufes y purga - Perfil ISO 6150 B - Paso 6 mm

T1

Entrada rosca hembra BSPP	Salida : 2 enchufes	Referencia	Emba.
G 1/2	ISI 06	ISI 068103WK	1
G 3/4	ISI 06	ISI 068104WK	1



PRODUCTOS ASOCIADOS



Prolongadores de tubo con enchufes - p 120



Apliques murales mixtos PrevoS1 - p 93

CONECTORES PARA ENCHUFES RÁPIDOS - IRP 06

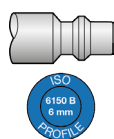

Conector rosca hembra cilíndrica

T1

Rosca hembra	Referencia	Emba.
G 1/4 BSPP	IRP 066101	10
G 1/4 BSPP con cono de estanqueidad	IRP 066101AE	10
G 3/8 BSPP	IRP 066102	10
Paso Michelin (paso 0,8) para pistola de inflado	IRP 066310	10
Devilbiss (paso 9/16" - 20 hilos por pulgada)	IRP 066315	10
1/4 NPSM	IRP 066301	10
M14 x 1,25 con cono de estanqueidad	IRP 066314	10



CONECTORES PARA ENCHUFES RÁPIDOS - IRP 06



Conector rosca macho cónico

T1

Rosca macho	Referencia	Emba.
R 1/4	IRP 066151	10
R 3/8	IRP 066152	10
M14 x 1,25	IRP 066354	10
Rosca con tratamiento previo de teflón		



Conector para tubo

T1

Para tubo Ø int. (mm)	Referencia	Emba.
6	IRP 066806	10
8	IRP 066808	10
10	IRP 066810	10
13	IRP 066813	10



Conector para tubo semi-rígido PA/PU

T1

Diámetro (mm)	Referencia	Emba.
4 x 6	IRP 066804RB	10
6 x 8	IRP 066806RB	10
8 x 10	IRP 066808RB	10



Conector con racor de sujeción para tubo PA/PU

T1

Diámetro (mm)	Referencia	Emba.
6 x 12	IRP 066806CO	10
8 x 14	IRP 066808CO	10
9 x 15	IRP 066809CO	10
10 x 16	IRP 066810CO	10



ENCHUFES RÁPIDOS DE SEGURIDAD PREVO S1 - ISI 08



Enchufe rosca hembra cilíndrica

T1

Rosca hembra BSPP	Referencia	Emba.
G 1/4	ISI 081101	5
G 3/8	ISI 081102	5
G 1/2	ISI 081103	5



ENCHUFES RÁPIDOS DE SEGURIDAD PREVO S1 - ISI 08



Enchufe orientable rosca hembra cilíndrica

T1

Rosca hembra BSPP	Referencia	Emba.
G 3/8	ISI 081102SW	1

Enlace orientable roscado
Rotación sobre 2 ejes a 360°



Enchufe rosca macho cilíndrico con junta

T1

Rosca macho BSPP	Referencia	Emba.
G 1/4	ISI 081151	5
G 3/8	ISI 081152	5
G 1/2	ISI 081153	5



Distribuidor fijo de 2 direcciones rosca hembra cilíndrica

T1

Rosca hembra BSPP	Referencia	Emba.
G 3/8	ISI 088102	1
G 1/2	ISI 088103	1
G 3/4	ISI 088104	1



Enchufe para tubo

T1

Para tubo Ø int. (mm)	Referencia	Emba.
8	ISI 081808	5
10	ISI 081810	5
13	ISI 081813	5
16	ISI 081816	5



Distribuidor fijo de 2 direcciones rosca macho cónico

T1

Rosca macho BSPT	Referencia	Emba.
R 3/8	ISI 088152	1
R 1/2	ISI 088153	1
R 3/4	ISI 088154	1



ENCHUFES RÁPIDOS DE SEGURIDAD PREVO S1 - ISI 08



Enchufe pasatabiques

T1

Rosca hembra BSPP	Paso (mm)	Espesor del tabique (mm)	Referencia	Emba.
G 1/2	27	11	ISI 082103	1



Aplique mural rosca hembra - 1 enchufe y purga - Perfil ISO 6150 B - Paso 8 mm

T1

Entrada rosca hembra BSPP	Salida : 1 enchufe	Referencia	Emba.
G 1/2	ISI 08	ISI 081103WK	1



Aplique mural rosca hembra - 2 enchufes y purga - Perfil ISO 6150 B - Paso 8 mm

T1

Entrada rosca hembra BSPP	Salida : 2 enchufes	Referencia	Emba.
G 1/2	ISI 08	ISI 088103WK	1
G 3/4	ISI 08	ISI 088104WK	1

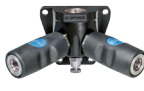

PRODUCTOS ASOCIADOS



Prolongadores de tubo con enchufes - p 120



Apliques murales mixtos PrevoS1 - p 93

CONECTORES PARA ENCHUFES RÁPIDOS - IRP 08

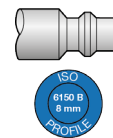

Conector rosca hembra cilíndrica

T1

Rosca hembra BSPP	Referencia	Emba.
G 1/4	IRP 086101	10
G 3/8	IRP 086102	10
G 1/2	IRP 086103	10



Conector rosca macho cónico

T1

Rosca macho BSPT	Referencia	Emba.
R 1/4	IRP 086151	10
R 3/8	IRP 086152	10
R 1/2	IRP 086153	10

Rosca con tratamiento previo de teflón



Conector para tubo

T1

Para tubo Ø int. (mm)	Referencia	Emba.
8	IRP 086808	10
10	IRP 086810	10
13	IRP 086813	10
16	IRP 086816	10



ENCHUFES RÁPIDOS DE SEGURIDAD METAL - PREVO S1 - ISI 11

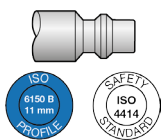

Enchufe rosca hembra cilíndrica

T1

Rosca hembra BSPP	Referencia	Emba.
G 3/8	ISI 111102	1
G 1/2	ISI 111103	1
G 3/4	ISI 111104	1



Enchufe rosca macho cilíndrico con junta

T1

Rosca macho BSPP	Referencia	Emba.
G 3/8	ISI 111152	1
G 1/2	ISI 111153	1
G 3/4	ISI 111154	1



Enchufe para tubo

T1

Para tubo Ø int. (mm)	Referencia	Emba.
10	ISI 111810	1
13	ISI 111813	1
16	ISI 111816	1
19	ISI 111819	1



Aplique mural rosca hembra - 1 enchufe y purga - Perfil ISO 6150 B - Paso 11 mm

T1

Entrada rosca hembra BSPP	Salida : 1 enchufe	Referencia	Emba.
G 1/2	ISI 11	ISI 111103WK	1



ENCHUFES RÁPIDOS DE SEGURIDAD METAL - PREVO S1 - ISI 11



Aplique mural rosca hembra - 2 enchufes y purga - Perfil ISO 6150 B - Paso 11 mm

T1

Entrada rosca hembra BSPP	Salida : 2 enchufes	Referencia	Emba.
G 3/4	ISI 11	ISI 118104WK	1



PRODUCTOS ASOCIADOS



Prolongadores de tubo con enchufes - p 120



Apliques murales mixtos PrevoS1 - p 93

CONECTORES PARA ENCHUFES RÁPIDOS - IRP 11

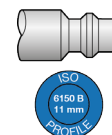

Conector rosca hembra cilíndrica

T1

Rosca hembra BSPP	Referencia	Emba.
G 3/8	IRP 116102	1
G 1/2	IRP 116103	1



Conector rosca macho cónico

T1

Rosca macho BSPT	Referencia	Emba.
R 3/8	IRP 116152	1
R 1/2	IRP 116153	1
Rosca con tratamiento previo de teflón		



Conector para tubo

T1

Para tubo Ø int. (mm)	Referencia	Emba.
10	IRP 116810	1
13	IRP 116813	1
16	IRP 116816	1
19	IRP 116819	1



ENCHUFES RÁPIDOS DE SEGURIDAD PREVO S1 - ESI 07



Enchufe rosca hembra cilíndrica

T1

Rosca hembra BSPP	Referencia	Emba.
G 1/4	ESI 071101	10
G 3/8	ESI 071102	10
G 1/2	ESI 071103	10



Enchufe rosca macho cilíndrico con junta

T1

Rosca macho BSPP	Referencia	Emba.
G 1/4	ESI 071151	10
G 3/8	ESI 071152	10
G 1/2	ESI 071153	10



Enchufe para tubo

T1

Para tubo Ø int. (mm)	Referencia	Emba.
6	ESI 071806	10
8	ESI 071808	10
9	ESI 071809	10
10	ESI 071810	10
13	ESI 071813	10



Enchufe orientable rosca hembra cilíndrica

T1

Rosca hembra BSPP	Referencia	Emba.
G 3/8	ESI 071102SW	1

Enlace orientable roscado
Rotación sobre 2 ejes a 360°



ENCHUFES RÁPIDOS DE SEGURIDAD PREVO S1 - ESI 07



Enchufe rotativo rosca macho cilíndrico con junta de impermeabilidad

T1

Rosca macho BSPP	Referencia	Emba.
G 1/2	ESI 071153SE	1

Rotación sobre un eje a 360 °
Cuerpo del codo en aluminio anodizado negro



Enchufe pasatabiques

T1

Rosca hembra BSPP	Paso (mm)	Espesor del tabique (mm)	Referencia	Emba.
G 1/2	27	11	ESI 072103	1



Distribuidor fijo de 2 direcciones rosca hembra cilíndrica

T1

Rosca hembra BSPP	Referencia	Emba.
G 3/8	ESI 078102	1
G 1/2	ESI 078103	1



ENCHUFES RÁPIDOS DE SEGURIDAD PREVO S1 - ESI 07



Distribuidor fijo de 2 direcciones rosca macho cónico T1

Rosca macho BSPT	Referencia	Emba.
R 3/8	ESI 078152	1
R 1/2	ESI 078153	1



Aplique mural rosca hembra - 1 enchufe y purga - Perfil European - Paso 7,4 mm T1

Entrada rosca hembra BSPP	Salida : 1 enchufe	Referencia	Emba.
G 1/2	ESI 07	ESI 071103WK	1



Aplique mural rosca hembra - 2 enchufes y purga - Perfil European - Paso 7,4 mm T1

Entrada rosca hembra BSPP	Salida : 2 enchufes	Referencia	Emba.
G 1/2	ESI 07	ESI 078103WK	1
G 3/4	ESI 07	ESI 078104WK	1



PRODUCTOS ASOCIADOS



Prolongadores de tubo con enchufes - p 121



Apliques murales mixtos PrevoS1 - p 94

CONECTORES PARA ENCHUFES RÁPIDOS - ERP 07



Conector rosca hembra cilíndrica T1

Rosca hembra BSPP	Referencia	Emba.
G 1/4	ERP 076101	10
G 3/8	ERP 076102	10
G 1/2	ERP 076103	10



Conector rosca macho cónico T1

Rosca macho BSPT	Referencia	Emba.
R 1/4	ERP 076151	10
R 3/8	ERP 076152	10
R 1/2	ERP 076153	10

Rosca con tratamiento previo de teflón



Conector para tubo T1

Para tubo Ø int. (mm)	Referencia	Emba.
6	ERP 076806	10
8	ERP 076808	10
9	ERP 076809	10
10	ERP 076810	10
13	ERP 076813	10



Conector para tubo semi-rigido PA/PU T1

Diámetro (mm)	Referencia	Emba.
4 x 6	ERP 076804RB	10
6 x 8	ERP 076806RB	10
8 x 10	ERP 076808RB	10



ENCHUFES RÁPIDOS DE SEGURIDAD - INOX - PREVO S1 - ESI 07HE



Enchufe rosca hembra cilíndrica

T1

Rosca hembra BSPP	Referencia	Emba.
G 1/4	ESI 071101HE	1
G 3/8	ESI 071102HE	1
G 1/2	ESI 071103HE	1



CONECTORES INOX PARA ENCHUFES RÁPIDOS PREVO S1 - ERP 07HE



Conector rosca hembra cilíndrica

T1

	Referencia	Emba.
G 1/4	ERP 076101HE	1
G 3/8	ERP 076102HE	1



Enchufe rosca macho cilíndrico con junta

T1

	Referencia	Emba.
G 1/4	ESI 071151HE	1
G 3/8	ESI 071152HE	1
G 1/2	ESI 071153HE	1



Conector rosca macho cónico

T1

	Referencia	Emba.
R 1/4	ERP 076151HE	1
R 3/8	ERP 076152HE	1

Rosca con tratamiento previo de teflón



Enchufe para tubo

T1

	Referencia	Emba.
8	ESI 071808HE	1
9	ESI 071809HE	1
10	ESI 071810HE	1



Conector para tubo

T1

Para tubo Ø int. (mm)	Referencia	Emba.
8	ERP 076808HE	1
9	ERP 076809HE	1
10	ERP 076810HE	1



ENCHUFES RÁPIDOS DE SEGURIDAD PREVO S1 - ESI 11CB



Enchufe rosca hembra cilíndrica

T1

NUEVO	Rosca hembra BSPP	Referencia	Emba.
	G 3/8	ESI 111102CB	1
	G 1/2	ESI 111103CB	1
	G 3/4	ESI 111104CB	1

CONECTORES PARA ENCHUFES RÁPIDOS - ERP 11



Conector rosca hembra cilíndrica

T1

Rosca hembra BSPP	Referencia	Emba.
G 1/4	ERP 116101	1
G 3/8	ERP 116102	1
G 1/2	ERP 116103	1
G 3/4	ERP 116104	1

Enchufe rosca macho cilíndrico con junta

T1

NUEVO	Rosca macho BSPP	Referencia	Emba.
	G 3/8	ESI 111152CB	1
	G 1/2	ESI 111153CB	1
	G 3/4	ESI 111154CB	1

Conector rosca macho cónico

T1

Rosca macho BSPT	Referencia	Emba.
R 1/4	ERP 116151	1
R 3/8	ERP 116152	1
R 1/2	ERP 116153	1
R 3/4	ERP 116154	1

Rosca con tratamiento previo de teflón

Enchufe para tubo

T1

NUEVO	Para tubo Ø int. (mm)	Referencia	Emba.
	9	ESI 111809CB	1
	10	ESI 111810CB	1
	13	ESI 111813CB	1
	16	ESI 111816CB	1
	19	ESI 111819CB	1

Conector para tubo

T1

Para tubo Ø int. (mm)	Referencia	Emba.
9	ERP 116809	1
10	ERP 116810	1
13	ERP 116813	1
16	ERP 116816	1
19	ERP 116819	1

ENCHUFES RÁPIDOS DE SEGURIDAD PREVO S1 - ESI 11



Enchufe rosca hembra cilíndrica

T1

Rosca hembra BSPP	Referencia	Emba.
G 3/8	ESI 111102	1
G 1/2	ESI 111103	1
G 3/4	ESI 111104	1



Enchufe rosca macho cilíndrico con junta

T1

Rosca macho BSPP	Referencia	Emba.
G 3/8	ESI 111152	1
G 1/2	ESI 111153	1
G 3/4	ESI 111154	1



Enchufe para tubo

T1

Para tubo Ø int. (mm)	Referencia	Emba.
9	ESI 111809	1
10	ESI 111810	1
13	ESI 111813	1
16	ESI 111816	1
19	ESI 111819	1



Aplique mural rosca hembra - 1 enchufe y purga - Perfil European - Paso 10,4 mm

T1

Entrada rosca hembra BSPP	Salida : 1 enchufe	Referencia	Emba.
G 1/2	ESI 11	ESI 111103WK	1



ENCHUFES RÁPIDOS DE SEGURIDAD PREVO S1 - ESI 11



Aplique mural rosca hembra - 2 enchufes y purga - Perfil European - Paso 10,4 mm

T1

Entrada rosca hembra BSPP	Salida : 2 enchufes	Referencia	Emba.
G 3/4	ESI 11	ESI 118104WK	1



PRODUCTOS ASOCIADOS



Prolongadores de tubo con enchufes - p 120



PrevoS1 Apliques murales mixtos - p 94

CONECTORES PARA ENCHUFES RÁPIDOS - ERP 11



Conector rosca hembra cilíndrica

T1

Rosca hembra BSPP	Referencia	Emba.
G 1/4	ERP 116101	1
G 3/8	ERP 116102	1
G 1/2	ERP 116103	1
G 3/4	ERP 116104	1



Conector rosca macho cónico

T1

Rosca macho BSPT	Referencia	Emba.
R 1/4	ERP 116151	1
R 3/8	ERP 116152	1
R 1/2	ERP 116153	1
R 3/4	ERP 116154	1

Rosca con tratamiento previo de teflón



Conector para tubo

T1

Para tubo Ø int. (mm)	Referencia	Emba.
9	ERP 116809	1
10	ERP 116810	1
13	ERP 116813	1
16	ERP 116816	1
19	ERP 116819	1



ENCHUFES RÁPIDOS DE SEGURIDAD PREVO S1 - CSI 06



Enchufe rosca hembra cilíndrica

T1

Rosca hembra BSPP	Referencia	Emba.
G 1/4	CSI 061101	10
G 3/8	CSI 061102	10
G 1/2	CSI 061103	10



ENCHUFES RÁPIDOS DE SEGURIDAD PREVO S1 - CSI 06



Enchufe orientable rosca hembra

T1

Rosca hembra BSPP	Referencia	Emba.
G 3/8	CSI 061102SW	1

Enlace orientable roscado
Rotación sobre 2 ejes a 360°



Enchufe rosca macho cilíndrico con junto

T1

Rosca macho BSPP	Referencia	Emba.
G 1/4	CSI 061151	10
G 3/8	CSI 061152	10
G 1/2	CSI 061153	10



Enchufe rotativo rosca macho cilíndrico con junta de impermeabilidad

T1

Rosca macho BSPP	Referencia	Emba.
G 1/2	CSI 061153SE	1

Rotación sobre un eje a 360 °
Cuerpo del codo en aluminio anodizado negro



Enchufe para tubo

T1

Para tubo Ø int. (mm)	Referencia	Emba.
6	CSI 061806	10
8	CSI 061808	10
10	CSI 061810	10
13	CSI 061813	10



Enchufe pasatabiques

T1

Rosca hembra BSPP	Ø de taladrado (mm)	Espesor del tabique (mm)	Referencia	Emba.
G 1/4	27	11	CSI 062101	1



ENCHUFES RÁPIDOS DE SEGURIDAD PREVO S1 - CSI 06



Distribuidor fijo de 2 direcciones rosca hembra cilíndrica T1

Rosca hembra BSPP	Referencia	Emba.
G 1/4	CSI 068101	1
G 3/8	CSI 068102	1
G 1/2	CSI 068103	1



Distribuidor fijo de 2 direcciones rosca macho cónico T1

Rosca macho BSPT	Referencia	Emba.
R 1/4	CSI 068151	1
R 3/8	CSI 068152	1
R 1/2	CSI 068153	1



Aplique mural rosca hembra - 1 enchufe y purga - Perfil ISO 6150 C - Paso 6 mm T1

Entrada rosca hembra BSPP	Salida : 1 enchufe	Referencia	Emba.
G 1/2	CSI 06	CSI 061103WK	1



Aplique mural rosca hembra - 2 enchufes y purga - Perfil ISO 6150 C - Paso 6 mm T1

Entrada rosca hembra BSPP	Salida : 2 enchufes	Referencia	Emba.
G 1/2	CSI 06	CSI 068103WK	1
G 3/4	CSI 06	CSI 068104WK	1



PRODUCTOS ASOCIADOS



Prolongadores de tubo con enchufes - p 120



Apliques murales mixtos PrevoS1 - p 94

CONECTORES PARA ENCHUFES RÁPIDOS - CRP 06



Conector rosca hembra cilíndrica T1

Rosca hembra BSPP	Referencia	Emba.
G 1/4	CRP 066101	10
G 3/8	CRP 066102	10



Conector rosca macho cilíndrico T1

Rosca macho BSPP	Referencia	Emba.
G 1/8	CRP 066150	10
G 1/4	CRP 066151	10
G 3/8	CRP 066152	10



Conector para tubo T1

Para tubo Ø int. (mm)	Referencia	Emba.
6	CRP 066806	10
8	CRP 066808	10
10	CRP 066810	10
13	CRP 066813	10



Conector para tubo semi-rígido PA/PU T1

Diámetro (mm)	Referencia	Emba.
4 x 6	CRP 066804RB	10
6 x 8	CRP 066806RB	10
8 x 10	CRP 066808RB	10



ENCHUFES RÁPIDOS DE SEGURIDAD PREVO S1 - CSI 08



Enchufe rosca hembra cilíndrica

T1

Rosca hembra BSPP	Referencia	Emba.
G 1/4	CSI 081101	5
G 3/8	CSI 081102	5
G 1/2	CSI 081103	5



ENCHUFES RÁPIDOS DE SEGURIDAD PREVO S1 - CSI 08



Enchufe orientable rosca hembra cilíndrica

T1

Rosca hembra BSPP	Referencia	Emba.
G 3/8	CSI 081102SW	1

Enlace orientable roscado
Rotación sobre 2 ejes a 360°



Enchufe rosca macho cilíndrico con junto

T1

Rosca macho BSPP	Referencia	Emba.
G 1/4	CSI 081151	5
G 3/8	CSI 081152	5
G 1/2	CSI 081153	5



Distribuidor fijo de 2 direcciones rosca hembra cilíndrica

T1

Rosca hembra BSPP	Referencia	Emba.
G 3/8	CSI 088102	1
G 1/2	CSI 088103	1



Enchufe para tubo

T1

Para tubo Ø int. (mm)	Referencia	Emba.
8	CSI 081808	5
10	CSI 081810	5
13	CSI 081813	5
16	CSI 081816	5



Distribuidor fijo de 2 direcciones rosca macho cónico

T1

Rosca macho BSPT	Referencia	Emba.
R 3/8	CSI 088152	1
R 1/2	CSI 088153	1



ENCHUFES RÁPIDOS DE SEGURIDAD PREVO S1 - CSI 08



Enchufe pasatabiques

T1

Rosca hembra BSPP	Ø de taladrado (mm)	Espesor del tabique (mm)	Referencia	Emba.
G 1/2	27	11	CSI 082103	1



Aplique mural rosca hembra - 1 enchufe y purga - Perfil ISO 6150 C - Paso 8 mm

T1

Entrada rosca hembra BSPP	Salida : 1 enchufe	Referencia	Emba.
G 1/2	CSI 08	CSI 081103WK	1



Aplique mural rosca hembra - 2 enchufes y purga - Perfil ISO 6150 C - Paso 8 mm

T1

Entrada rosca hembra BSPP	Salida : 2 enchufes	Referencia	Emba.
G 1/2	CSI 08	CSI 088103WK	1
G 3/4	CSI 08	CSI 088104WK	1



PRODUCTOS ASOCIADOS



Prolongadores de tubo con enchufes - p 120



Apliques murales mixtos PrevoS1 - p 94

CONECTORES PARA ENCHUFES RÁPIDOS - CRP 08



Conector rosca hembra cilíndrica

T1

Rosca hembra BSPP	Referencia	Emba.
G 1/4	CRP 086101	10
G 3/8	CRP 086102	10
G 1/2	CRP 086103	10



Conector rosca macho cilíndrico

T1

Rosca macho BSPP	Referencia	Emba.
G 1/4	CRP 086151	10
G 3/8	CRP 086152	10
G 1/2	CRP 086153	10



Conector para tubo

T1

Para tubo Ø int. (mm)	Referencia	Emba.
6	CRP 086806	10
8	CRP 086808	10
10	CRP 086810	10
13	CRP 086813	10
16	CRP 086816	10



ENCHUFES RÁPIDOS METÁLICOS DE SEGURIDAD - CSM 06



Enchufe rosca hembra cilíndrica

T1

Rosca hembra BSPP	Referencia	Emba.
G 1/4	CSM 061101	10
G 3/8	CSM 061102	10
G 1/2	CSM 061103	10

Enchufe rosca macho cilíndrica

T1

Rosca macho BSPP	Referencia	Emba.
G 1/4	CSM 061151	10
G 3/8	CSM 061152	10
G 1/2	CSM 061153	10

Enchufe para tubo

T1

Para tubo Ø int. (mm)	Referencia	Emba.
6	CSM 061806	10
8	CSM 061808	10
10	CSM 061810	10
13	CSM 061813	10

Enchufe orientable rosca hembra cilíndrica

T1

Rosca hembra BSPP	Referencia	Emba.
G 3/8	CSM 061102SW	1

Enlace orientable roscado
Rotación sobre 2 ejes a 360°

Distribuidor fijo de 2 direcciones rosca hembra cilíndrica

T1

Rosca hembra BSPP	Referencia	Emba.
G 1/4	CSM 068101	1
G 3/8	CSM 068102	1
G 1/2	CSM 068103	1

Distribuidor fijo de 2 direcciones rosca macho cónico

T1

Rosca macho BSPT	Referencia	Emba.
R 1/4	CSM 068151	1
R 3/8	CSM 068152	1
R 1/2	CSM 068153	1

CONECTORES PARA ENCHUFES RÁPIDOS - CRP 06



Conector rosca hembra cilíndrica

T1

Rosca hembra BSPP	Referencia	Emba.
G 1/4	CRP 066101	10
G 3/8	CRP 066102	10

Conector rosca macho cilíndrico

T1

Rosca macho BSPP	Referencia	Emba.
G 1/8	CRP 066150	10
G 1/4	CRP 066151	10
G 3/8	CRP 066152	10

Conector para tubo

T1

Para tubo Ø int. (mm)	Referencia	Emba.
6	CRP 066806	10
8	CRP 066808	10
10	CRP 066810	10
13	CRP 066813	10

Conector para tubo semi-rígido PA/PU

T1

Diámetro (mm)	Referencia	Emba.
4 x 6	CRP 066804RB	10
6 x 8	CRP 066806RB	10
8 x 10	CRP 066808RB	10

PRODUCTOS ASOCIADOS



Prolongadores de tubo con enchufes - p 120

ENCHUFES RÁPIDOS METÁLICOS DE SEGURIDAD - CSM 08



Enchufe rosca hembra cilíndrica

T1

Rosca hembra BSPP	Referencia	Emba.
G 1/4	CSM 081101	5
G 3/8	CSM 081102	5
G 1/2	CSM 081103	5

Enchufe rosca macho cilíndrico

T1

Rosca macho BSPP	Referencia	Emba.
G 1/4	CSM 081151	5
G 3/8	CSM 081152	5
G 1/2	CSM 081153	5

Enchufe para tubo

T1

Para tubo Ø int. (mm)	Referencia	Emba.
8	CSM 081808	5
10	CSM 081810	5
13	CSM 081813	5
16	CSM 081816	5

Enchufe orientable rosca hembra cilíndrica

T1

Rosca hembra BSPP	Referencia	Emba.
G 3/8	CSM 081102SW	1

Enlace orientable roscado
Rotación sobre 2 ejes a 360°

Distribuidor fijo de 2 direcciones rosca hembra cilíndrica

T1

Rosca hembra BSPP	Referencia	Emba.
G 3/8	CSM 088102	1
G 1/2	CSM 088103	1
G 3/4	CSM 088104	1

Distribuidor fijo de 2 direcciones rosca macho cónico

T1

Rosca macho BSPT	Referencia	Emba.
R 3/8	CSM 088152	1
R 1/2	CSM 088153	1
R 3/4	CSM 088154	1

CONECTORES PARA ENCHUFES RÁPIDOS - CRP 08



Conector rosca hembra cilíndrica

T1

Rosca hembra BSPP	Referencia	Emba.
G 1/4	CRP 086101	10
G 3/8	CRP 086102	10
G 1/2	CRP 086103	10

Conector rosca macho cilíndrico

T1

Rosca macho BSPP	Referencia	Emba.
G 1/4	CRP 086151	10
G 3/8	CRP 086152	10
G 1/2	CRP 086153	10

Conector para tubo

T1

Para tubo Ø int. (mm)	Referencia	Emba.
6	CRP 086806	10
8	CRP 086808	10
10	CRP 086810	10
13	CRP 086813	10
16	CRP 086816	10

PRODUCTOS ASOCIADOS



Prolongadores de tubo con enchufes - p 120

ENCHUFES RÁPIDOS METÁLICOS DE SEGURIDAD - CSM 11



Enchufe rosca hembra cilíndrica

T1

Rosca hembra BSPP	Referencia	Emba.
G 3/8	CSM 111102	1
G 1/2	CSM 111103	1
G 3/4	CSM 111104	1

Enchufe rosca macho cilíndrico

T1

Rosca macho BSPP	Referencia	Emba.
G 3/8	CSM 111152	1
G 1/2	CSM 111153	1
G 3/4	CSM 111154	1

Enchufe para tubo

T1

Para tubo Ø int. (mm)	Referencia	Emba.
10	CSM 111810	1
13	CSM 111813	1
16	CSM 111816	1
19	CSM 111819	1

Distribuidor fijo de 2 direcciones rosca hembra cilíndrica

T1

Rosca hembra BSPP	Referencia	Emba.
G 1/2	CSM 118103	1
G 3/4	CSM 118104	1

Distribuidor fijo de 2 direcciones rosca macho cónico

T1

Rosca macho BSPT	Referencia	Emba.
R 1/2	CSM 118153	1
R 3/4	CSM 118154	1

CONECTORES PARA ENCHUFES RÁPIDOS - CRP 11



Conector rosca hembra cilíndrica

T1

Rosca hembra BSPP	Referencia	Emba.
G 3/8	CRP 116102	1
G 1/2	CRP 116103	1
G 3/4	CRP 116104	1

Conector rosca macho cilíndrica

T1

Rosca macho BSPP	Referencia	Emba.
G 3/8	CRP 116152	1
G 1/2	CRP 116153	1
G 3/4	CRP 116154	1

Conector para tubo

T1

Para tubo Ø int. (mm)	Referencia	Emba.
10	CRP 116810	1
13	CRP 116813	1
16	CRP 116816	1
19	CRP 116819	1

PRODUCTOS ASOCIADOS



Prolongadores de tubo con enchufes - p 120

ENCHUFES RÁPIDOS DE SEGURIDAD - ISG 11

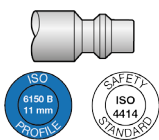

Enchufe rosca hembra cilíndrica

T1

	Rosca hembra BSPP	Referencia	Emba.
	G 3/8	ISG 111102	1
	G 1/2	ISG 111103	1
	G 3/4	ISG 111104	1

Enchufe rosca macho cilíndrica

T1

	Rosca macho BSPP	Referencia	Emba.
	G 3/8	ISG 111152	1
	G 1/2	ISG 111153	1
	G 3/4	ISG 111154	1

Enchufe para tubo

T1

	Para tubo Ø int. (mm)	Referencia	Emba.
	10	ISG 111810	1
	13	ISG 111813	1
	16	ISG 111816	1
	19	ISG 111819	1

Distribuidor fijo de 2 direcciones rosca hembra cilíndrica

T1

	Rosca hembra BSPP	Referencia	Emba.
	G 1/2	ISG 118103	1
	G 3/4	ISG 118104	1

Distribuidor fijo de 2 direcciones rosca macho cónico

T1

	Rosca macho BSPT	Referencia	Emba.
	R 1/2	ISG 118153	1
	R 3/4	ISG 118154	1

Aplique mural rosca hembra - 1 enchufe y purga - Perfil ISO 6150 B - ISG - Paso 11 mm

T1

	Entrada rosca hembra BSPP	Salida : 1 enchufe	Referencia	Emba.
	G 1/2	ISG 11	ISG 111103WK	1

ENCHUFES RÁPIDOS DE SEGURIDAD - ISG 11



Aplique mural rosca hembra - 2 enchufes y purga - Perfil ISO 6150 B - ISG - Paso 11 mm

T1

	Entrada rosca hembra BSPP	Salida : 2 enchufes	Referencia	Emba.
	G 3/4	ISG 11	ISG 118104WK	1

PRODUCTOS ASOCIADOS



Prolongadores de tubo con enchufes - p 120



Appliques murales duo équipées - p 94

CONECTORES PARA ENCHUFES RÁPIDOS - IRP 11



Conector rosca hembra cilíndrica

T1

	Rosca hembra BSPP	Referencia	Emba.
	G 3/8	IRP 116102	1
	G 1/2	IRP 116103	1

Conector rosca macho cónico

T1

	Rosca macho BSPT	Referencia	Emba.
	R 3/8	IRP 116152	1
	R 1/2	IRP 116153	1
Rosca con tratamiento previo de teflón			

Conector para tubo

T1

	Para tubo Ø int. (mm)	Referencia	Emba.
	10	IRP 116810	1
	13	IRP 116813	1
	16	IRP 116816	1
	19	IRP 116819	1

ENCHUFES RÁPIDOS DE SEGURIDAD - MSC 06



Enchufe rosca hembra cilíndrica

T1

	Rosca hembra BSPP	Referencia	Emba.
	G 1/4	MSC 061101	10
	G 3/8	MSC 061102	10
	G 1/2	MSC 061103	10

Enchufe rosca macho cilíndrico

T1

	Rosca macho BSPP	Referencia	Emba.
	G 1/2	MSC 061133	10

Enchufe para tubo

T1

	Para tubo Ø int. (mm)	Referencia	Emba.
	8	MSC 061808	10
	10	MSC 061810	10

CONECTORES PARA ENCHUFES - MRP 06



Conector rosca hembra cilíndrica

T1

	Rosca hembra BSPP	Referencia	Emba.
	G 1/4	MRP 066101	10

Conector rosca macho cilíndrico

T1

	Rosca macho BSPT	Referencia	Emba.
	G 1/4	MRP 066151	10

Conector para tubo

T1

	Para tubo Ø int. (mm)	Referencia	Emba.
	8	MRP 066808	10
	10	MRP 066810	10

ENCHUFES Y CONECTORES ESTUCHE DE JUEGO

Estuche de juego de enchufes de seguridad y conectores - Perfil ISO 6150 B

T1

	Dénominación	Referencia	Emba.
	Estuche de juego de enchufes y conectores - Perfil ISO 6150 B	BR 600IS	1
Estuche con : - 2 enchufes G 1/4 hembra - ISI 061101 - 2 conectores G 1/4 hembra - IRP 066101 - 1 conector G 1/4 hembra con cono de estanqueidad - IRP 066101AE - 2 conectores R 1/4 macho - IRP 066151 - 2 conectores para tubo Ø 8 mm - IRP 066808 - 2 empalmes R 1/4 macho para tubo Ø 8 mm - JFT 1408 - 2 abrazaderas de orejas - 1315 - 2 abrazaderas de orejas - 1517			

Estuche de juego de enchufes de seguridad y conectores - Perfil ISO 6150 C

T1

	Dénominación	Referencia	Emba.
	Estuche de enchufes y conectores - Perfil ISO 6150 C	BR 600CS	1
Estuche con : - 2 enchufes G 1/4 BSP hembra - CSI 061101 - 2 conectores G 1/4 BSP hembra - CRP 066101 - 2 conectores R 1/4 BSP macho - CRP 066151 - 2 conectores para tubo Ø 8 mm - CRP 066808 - 2 tetones macho - R 1/4 x R 1/4 - A2 1414 - 2 empalmes R 1/4 BSP macho para tubo Ø 8 mm - JFT 1408 - 2 abrazaderas de orejas - 1315 - 2 abrazaderas de orejas - 1517			

Estuche de juego de enchufe de seguridad, conectores y pistola de soplado - Perfil ISO 6150 B

T1

	Dénominación	Referencia	Emba.
	Estuche con enchufe y conectores - Perfil ISO 6150 B	BTE ISW	1
Caja con : - 1 enchufe orientable G 3/8 hembra : ISI 061102SW - 2 conectores G 1/4 hembra : IRP 066101 - 1 conector para tubo Ø 10 mm : IRP 066810 - 1 unión para tubo Ø 10 mm - JFT 3810ZS - G 3/8 - 2 abrazaderas de 2 orejas - 1720			

PROTECTORES DE ABRAZADERA DE OREJAS

Protector de caucho para enchufe

T1

NUEVO	Para tubo Ø ext. (mm)	Referencia	Emba.
	14 a 17	ECP S11417	1
	17 a 20	ECP S11720	1
	Permiten la unión 100% antirrayaduras entre el enchufe y el tubo, cubriendo la abrazadera de orejas		

Protector de caucho para enchufe orientable

T1

Compatibilidad	Referencia	Emba.
Protector de caucho para enchufe orientable FA	NSB FA	1



Protector de caucho para enchufe orientable

T1

Dénominación	Referencia	Emba.
Protector para enchufe orientable SW- Lado corto	PSW SH08	1
Protector para enchufe orientable SW- Lado largo	PSW TL08	1



Enchufes rápidos

(aire comprimido y otros fluidos)



Enchufes rápidos estándar PROLAC	_____	26 - 28
Enchufes rápidos estándar metálicos	_____	29 - 29
Enchufes rápidos INOX PROXI	_____	30
Enchufes aire respirable BAC 07	_____	30 - 31
Enchufes rápidos para circuitos de refrigeración CPI	_____	31 - 34
Enchufes rápidos para fluidos PREOL	_____	35 - 36
Enchufes automático para circuitos de agua ELS	_____	36 - 38
Enchufes express EXP	_____	38 - 39
Enchufes para soplete ISOFLAM	_____	39 - 42
Enchufes hidráulicos	_____	42 - 45

ENCHUFES RÁPIDOS ESTÁNDAR - IRC 06



Enchufe rosca hembra cilíndrica

T1

Rosca hembra BSPP	Referencia	Emba.
G 1/4	IRC 061101	10
G 3/8	IRC 061102	10
G 1/2	IRC 061103	10



ENCHUFES RÁPIDOS ESTÁNDAR - IRC 06



Enchufe orientable rosca hembra

T1

Rosca hembra BSPP	Referencia	Emba.
G 1/4	IRC 061101FA	1



Enchufe rosca macho cilíndrico

T1

Rosca macho BSPP	Referencia	Emba.
G 1/4	IRC 061151	10
G 3/8	IRC 061152	10
G 1/2	IRC 061153	10



Enchufe orientable para tubo

T1

Para tubo Ø int. (mm)	Referencia	Emba.
8	IRC 061808FA	1
10	IRC 061810FA	1



Enchufe para tubo

T1

Para tubo Ø int. (mm)	Referencia	Emba.
6	IRC 061806	10
8	IRC 061808	10
10	IRC 061810	10
13	IRC 061813	10



Distribuidor fijo de 2 direcciones rosca hembra cilíndrica

T1

Rosca hembra BSPP	Referencia	Emba.
G 1/4	IRC 068101	1
G 3/8	IRC 068102	1
G 1/2	IRC 068103	1

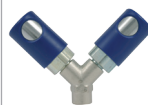

Enchufe con racor de sujeción para tubería

T1

Diámetro (mm)	Referencia	Emba.
6 x 12	IRC 061806CO	10
8 x 14	IRC 061808CO	10
9 x 15	IRC 061809CO	10
10 x 16	IRC 061810CO	10



Distribuidor fijo de 2 direcciones rosca macho cónico

T1

Rosca macho BSPT	Referencia	Emba.
R 1/4	IRC 068151	1
R 3/8	IRC 068152	1
R 1/2	IRC 068153	1



CONECTORES PARA ENCHUFES RÁPIDOS - IRP 06



Conector rosca hembra cilíndrica

T1

Rosca hembra	Referencia	Emba.
G 1/4 BSPP	IRP 066101	10
G 1/4 BSPP con cono de estanqueidad	IRP 066101AE	10
G 3/8 BSPP	IRP 066102	10
Paso Michelin (paso 0,8) para pistola de inflado	IRP 066310	10
Devilbiss (paso 9/16" - 20 hilos por pulgada)	IRP 066315	10
1/4 NPSM	IRP 066301	10
M14 x 1,25 con cono de estanqueidad	IRP 066314	10



Conector rosca macho cónico

T1

Rosca macho	Referencia	Emba.
R 1/4	IRP 066151	10
R 3/8	IRP 066152	10
M14 x 1,25	IRP 066354	10
Rosca con tratamiento previo de teflón		



Conector para tubo

T1

Para tubo Ø int. (mm)	Referencia	Emba.
6	IRP 066806	10
8	IRP 066808	10
10	IRP 066810	10
13	IRP 066813	10



Conector para tubo semi-rígido PA/PU

T1

Diámetro (mm)	Referencia	Emba.
4 x 6	IRP 066804RB	10
6 x 8	IRP 066806RB	10
8 x 10	IRP 066808RB	10



Conector con racor de sujeción para tubo PA/PU

T1

Diámetro (mm)	Referencia	Emba.
6 x 12	IRP 066806CO	10
8 x 14	IRP 066808CO	10
9 x 15	IRP 066809CO	10
10 x 16	IRP 066810CO	10



ENCHUFES RÁPIDOS ESTÁNDAR - IRC 08



Enchufe rosca hembra cilíndrica

T1

Rosca hembra BSPP	Referencia	Emba.
G 1/4	IRC 081101	5
G 3/8	IRC 081102	5
G 1/2	IRC 081103	5



Enchufe rosca macho cilíndrico

T1

Rosca macho BSPP	Referencia	Emba.
G 1/4	IRC 081151	5
G 3/8	IRC 081152	5
G 1/2	IRC 081153	5



Enchufe para tubo

T1

Para tubo Ø int. (mm)	Referencia	Emba.
8	IRC 081808	5
10	IRC 081810	5
13	IRC 081813	5
16	IRC 081816	5



Enchufe orientable rosca hembra

T1

Rosca hembra BSPP	Referencia	Emba.
G 1/4	IRC 081101FA	1
G 3/8	IRC 081102FA	1



Enchufe orientable para tubo

T1

Para tubo Ø int. (mm)	Referencia	Emba.
6	IRC 081806FA	1
8	IRC 081808FA	1
10	IRC 081810FA	1
13	IRC 081813FA	1



CONECTORES PARA ENCHUFES RÁPIDOS - IRP 08



Conector rosca hembra cilíndrica

T1

Rosca hembra BSPP	Referencia	Emba.
G 1/4	IRP 086101	10
G 3/8	IRP 086102	10
G 1/2	IRP 086103	10



Conector rosca macho cónico

T1

Rosca macho BSPT	Referencia	Emba.
R 1/4	IRP 086151	10
R 3/8	IRP 086152	10
R 1/2	IRP 086153	10

Rosca con tratamiento previo de teflón



Conector para tubo

T1

Para tubo Ø int. (mm)	Referencia	Emba.
8	IRP 086808	10
10	IRP 086810	10
13	IRP 086813	10
16	IRP 086816	10



ENCHUFES RÁPIDOS METÁLICOS - IRM 06



Enchufe rosca hembra cilíndrica

T1

Rosca hembra	Referencia	Emba.
G 1/4	IRM 061101	10
G 3/8	IRM 061102	10
G 1/2	IRM 061103	10
M14 x 1,25	IRM 061314	10



Enchufe rosca macho cilíndrico

T1

Rosca macho BSPP	Referencia	Emba.
G 1/4	IRM 061151	10
G 3/8	IRM 061152	10
G 1/2	IRM 061153	10



Enchufe para tubo

T1

Para tubo Ø int. (mm)	Referencia	Emba.
6	IRM 061806	10
8	IRM 061808	10
10	IRM 061810	10
13	IRM 061813	10



Enchufe pasatabiques

T1

Rosca hembra BSPP	Referencia	Emba.
G 1/4	IRM 062101	1

Ø Taladro en platina : 26 mm
Grosor de la platina : 10 mm maxi



ENCHUFES RÁPIDOS METÁLICOS - IRM 06

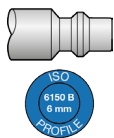

Distribuidor fijo de 2 direcciones rosca hembra cilíndrica T1

Rosca hembra BSPP	Referencia	Emba.
G 1/4	IRM 068101	1
G 3/8	IRM 068102	1
G 1/2	IRM 068103	1

CONECTORES PARA ENCHUFES RÁPIDOS - IRP 06



Conector rosca macho cónico T1

Rosca macho	Referencia	Emba.
R 1/4	IRP 066151	10
R 3/8	IRP 066152	10
M14 x 1,25	IRP 066354	10

Rosca con tratamiento previo de teflón

Distribuidor fijo de 2 direcciones rosca macho cónico T1

Rosca macho BSPT	Referencia	Emba.
R 1/4	IRM 068151	1
R 3/8	IRM 068152	1
R 1/2	IRM 068153	1

Conector para tubo T1

Para tubo Ø int. (mm)	Referencia	Emba.
6	IRP 066806	10
8	IRP 066808	10
10	IRP 066810	10
13	IRP 066813	10

CONECTORES PARA ENCHUFES RÁPIDOS - IRP 06



Conector rosca hembra cilíndrica T1

Rosca hembra	Referencia	Emba.
G 1/4 BSPP	IRP 066101	10
G 1/4 BSPP con cono de estanqueidad	IRP 066101AE	10
G 3/8 BSPP	IRP 066102	10
Paso Michelin (paso 0,8) para pistola de inflado	IRP 066310	10
Devilbiss (paso 9/16" - 20 hilos por pulgada)	IRP 066315	10
1/4 NPSM	IRP 066301	10
M14 x 1,25 con cono de estanqueidad	IRP 066314	10

Conector para tubo semi-rígido PA/PU T1

Diámetro (mm)	Referencia	Emba.
4 x 6	IRP 066804RB	10
6 x 8	IRP 066806RB	10
8 x 10	IRP 066808RB	10

Conector con racor de sujeción para tubo PA/PU T1

Diámetro (mm)	Referencia	Emba.
6 x 12	IRP 066806CO	10
8 x 14	IRP 066808CO	10
9 x 15	IRP 066809CO	10
10 x 16	IRP 066810CO	10

ENCHUFES RÁPIDOS ESTÁNDAR INOX - PROXI 06



Enchufe rosca hembra cilíndrica

T6

Rosca hembra BSPP	Referencia	Emba.
G 1/4	PROXI 061101	1
G 3/8	PROXI 061102	1
G 1/2	PROXI 061103	1

Enchufe rosca macho cilíndrico

T6

Rosca macho BSPP	Referencia	Emba.
G 1/4	PROXI 061151	1
G 3/8	PROXI 061152	1
G 1/2	PROXI 061153	1

Enchufe para tubo

T6

Para tubo Ø int. (mm)	Referencia	Emba.
6	PROXI 061806	1
8	PROXI 061808	1
10	PROXI 061810	1

Conector rosca hembra cilíndrico

T6

Rosca hembra BSPP	Referencia	Emba.
G 1/4	PROXI 066101	1

Conector para rosca macho cónico

T6

Rosca macho BSPT	Referencia	Emba.
R 1/4	PROXI 066151	1
R 3/8	PROXI 066152	1

Conector para tubo

T6

Para tubo Ø int. (mm)	Referencia	Emba.
6	PROXI 066806	1
8	PROXI 066808	1
10	PROXI 066810	1

ENCHUFES AIRE RESPIRABLE BAC 07

Enchufe rosca hembra cilíndrica

T1

Rosca hembra BSPP	Referencia	Emba.
G 1/4	BAC 071101	1

Enchufe rosca macho cilíndrico

T1

Rosca macho BSPP	Referencia	Emba.
G 1/4	BAC 071151	1
G 3/8	BAC 071152	1

Conector rosca macho cilíndrico

T1

Rosca macho BSPP	Referencia	Emba.
G 1/4	BAP 076151	1
G 3/8	BAP 076152	1

ENCHUFES AIRE RESPIRABLE BAC 07

Tapón de protección

T1

Compatibilidad	Referencia	Emba.
Para enchufes BAC	BAC 07CA	1



Tapón de protección

T1

Compatibilidad	Referencia	Emba.
Para conectores BAP	BAP 07CA	1



TUBOS DE ENLACE - AIRE RESPIRABLE - BAH

Tubo con enchufes y conectores

T1

Diámetro (mm)	Long. (m)	Referencia	Emba.
10 x 16	2	BAH 1002CP	1
10 x 16	10	BAH 1010CP	1
10 x 16	15	BAH 1015CP	1
10 x 16	20	BAH 1020CP	1



Tubo con uniones engastadas

T1

Rosca hembra BSPP	Diámetro (mm)	Long. (m)	Referencia	Emba.
G 3/8	10 x 16	10	BAH 1010	1
G 3/8	10 x 16	15	BAH 1015	1
G 3/8	10 x 16	20	BAH 1020	1



ENCHUFES PARA CIRCUITOS DE REFRIGERACIÓN - TOMAS Ø 8 MM

Toma recta rosca macho cónico

T1

Rosca macho BSPT	Referencia	Emba.
R 1/8	CPI 081160	10
R 1/4	CPI 081161	10
R 3/8	CPI 081162	10



Toma recta rosca macho cónico

T1

Rosca macho BSPT	Referencia	Emba.
R 1/8	CPI 081160ET	10
R 1/4	CPI 081161ET	10
R 3/8	CPI 081162ET	10
Rosca preteflonado		



Toma recta rosca hembra cilíndrica

T1

Rosca hembra BSPP	Referencia	Emba.
G 1/8	CPI 081100	10
G 1/4	CPI 081101	10



Toma 90° rosca macho cónico

T1

Rosca macho BSPT	Referencia	Emba.
R 1/8	CPI 081160RE	10
R 1/4	CPI 081161RE	10
R 3/8	CPI 081162RE	10



ENCHUFES PARA CIRCUITOS DE REFRIGERACIÓN - TOMAS Ø 8 MM

Toma 135° rosca macho cónico

T1

Rosca macho BSPT	Referencia	Emba.
R 1/8	CPI 081160RO	10
R 1/4	CPI 081161RO	10
R 3/8	CPI 081162RO	10

ENCHUFES PARA CIRCUITOS DE REFRIGERACIÓN - CONECTORES Ø 8 MM

Conector recto rosca hembra cilíndrica

T1

Rosca hembra BSPP	Referencia	Emba.
G 1/4	CPI 086101	10

Toma prolongada rosca macho cilíndrico G 1/8

T1

Longitud máx. (mm)	Referencia	Emba.
50	CPI 081050F18	1
100	CPI 081100F18	1
150	CPI 081150F18	1

Conector recta para tubo

T1

Para tubo Ø int. (mm)	Referencia	Emba.
8	CPI 086808	10
10	CPI 086810	10
12	CPI 086812	10

Toma prolongada rosca macho cilíndrico G 1/4

T1

Longitud máx. (mm)	Referencia	Emba.
50	CPI 081050F14	1
100	CPI 081100F14	1
150	CPI 081150F14	1
200	CPI 081200F14	1

Conector recta para tubo autoblocante

T1

Para tubo Ø int. (mm)	Referencia	Emba.
10	CPI 086810CN	10
13	CPI 086813CN	10

Al utilizar con tubo Lockflex

Toma prolongada lisa roscado a realizar G 1/4

T1

Long. (mm)	Referencia	Emba.
100	CPI 081100L14	1
150	CPI 081150L14	1
200	CPI 081200L14	1

Conector 90° rosca hembra cilíndrica

T1

Rosca hembra BSPP	Referencia	Emba.
G 1/4	CPI 086101RE	10

Anillo de identificación para toma Ø 8 mm

T1

Color del anillo	Referencia	Emba.
rojo	CPI 08BARG	10
azul	CPI 08BABL	10

Conector 90° para tubo

T1

Para tubo Ø int. (mm)	Referencia	Emba.
8	CPI 086808RE	10
10	CPI 086810RE	10
12	CPI 086812RE	10

ENCHUFES PARA CIRCUITOS DE REFRIGERACIÓN - CONECTORES Ø 8 MM

Conector 135° para tubo

T1

Para tubo Ø int. (mm)	Referencia	Emba.
8	CPI 086808RO	10
10	CPI 086810RO	10
12	CPI 086812RO	10

Conector 135° rosca hembra cilíndrica

T1

Rosca hembra BSPP	Referencia	Emba.
G 1/4	CPI 086101RO	10

Conector 90° para tubo autoblocante

T1

Para tubo Ø int. (mm)	Referencia	Emba.
10	CPI 086810CNRE	10
13	CPI 086813CNRE	10
Al utilizar con tubo Lockflex		

Conector 135° para tubo autoblocante

T1

Para tubo Ø int. (mm)	Referencia	Emba.
10	CPI 086810CNRO	10
13	CPI 086813CNRO	10
Al utilizar con tubo Lockflex		

Juntas de recambio de nitrilo

T1

Compatibilidad	Referencia	Emba.
Para conectores de diámetro 8 mm	CPI 08JNTN	10

ENCHUFES PARA CIRCUITOS DE REFRIGERACIÓN - TOMAS Ø 12 MM

Toma recta rosca macho cónico

T1

Rosca macho BSPT	Referencia	Emba.
R 3/8	CPI 121162	10
R 1/2	CPI 121163	10

Toma recta rosca macho cónico

T1

Rosca macho BSPT	Referencia	Emba.
R 3/8	CPI 121162ET	10
R 1/2	CPI 121163ET	10
Rosca preteflonado		

Toma prolongada fabricación lisa - roscado a realizar R 3/8 - NPT 3/8 - R 1/2 o NPT 1/2

T1

Rosca	Long. (mm)	Referencia	Emba.
3/8	150	CPI 121150L38	1
1/2	150	CPI 121150L12	1

Anillo de identificación para toma Ø 12 mm

T1

Color del anillo	Referencia	Emba.
rojo	CPI 12BARG	10
azul	CPI 12BABL	10

ENCHUFES PARA CIRCUITOS DE REFRIGERACIÓN - CONECTORES Ø 12 MM

Conector recto rosca hembra cilíndrica

T1

	Rosca hembra BSPP	Referencia	Emba.
	G 1/2	CPI 126103	10

Conector recta para tubo

T1

	Para tubo Ø int. (mm)	Referencia	Emba.
	13	CPI 126813	10
	16	CPI 126816	10

Conector 90° rosca hembra cilíndrica

T1

	Rosca hembra BSPP	Referencia	Emba.
	G 3/8	CPI 126102RE	10

Conector 90° para tubo

T1

	Para tubo Ø int. (mm)	Referencia	Emba.
	13	CPI 126813RE	10
	16	CPI 126816RE	10

Conector 135° para tubo

T1

	Para tubo Ø int. (mm)	Referencia	Emba.
	13	CPI 126813RO	10
	16	CPI 126816RO	10

ENCHUFES PARA CIRCUITOS DE REFRIGERACIÓN - CONECTORES Ø 12 MM

Conector 135° rosca hembra cilíndrica

T1

	Rosca hembra BSPP	Referencia	Emba.
	G 3/8	CPI 126102RO	10

Conector 90° para tubo autoblocante

T1

	Para tubo Ø int. (mm)	Referencia	Emba.
	13	CPI 126813CNRE	10
	16	CPI 126816CNRE	10
Al utilizar con tubo Lockflex			

Conector recto para tubo autoblocante

T1

	Para tubo Ø int. (mm)	Referencia	Emba.
	13	CPI 126813CN	10
	16	CPI 126816CN	10
Al utilizar con tubo Lockflex			

Conector 135° para tubo autoblocante

T1

	Para tubo Ø int. (mm)	Referencia	Emba.
	13	CPI 126813CNRO	10
	16	CPI 126816CNRO	10
Al utilizar con tubo Lockflex			

Juntas de recambio de nitrilo

T1

	Compatibilidad	Referencia	Emba.
	Para conectores de Ø 12 mm	CPI 12JNTN	10

ENCHUFES PREOL

Enchufe rosca hembra de obturación

T1

Paso (mm)	Rosca hembra BSPP	Referencia	Emba.
6	G 1/4	PREOL 061101	1
9	G 3/8	PREOL 091102	1
12	G 1/2	PREOL 121103	1
16	G 3/4	PREOL 161104	1



ENCHUFES PREOL

Enchufe rosca macho de obturación 90°

T1

Paso (mm)	Rosca macho BSPP	Referencia	Emba.
6	G 1/4	PREOL 061151RE	1
9	G 3/8	PREOL 091152RE	1
12	G 1/2	PREOL 121153RE	1



Enchufe rosca macho de obturación

T1

Paso (mm)	Rosca macho BSPP	Referencia	Emba.
6	G 1/4	PREOL 061151	1
9	G 3/8	PREOL 091152	1
12	G 1/2	PREOL 121153	1
16	G 3/4	PREOL 161154	1



Enchufe rosca hembra de obturación 135°

T1

Paso (mm)	Rosca hembra BSPP	Referencia	Emba.
6	G 1/4	PREOL 061101RO	1



Enchufe para tubo de obturación

T1

Paso (mm)	Para tubo Ø int. (mm)	Referencia	Emba.
6	8	PREOL 061808	1
9	12	PREOL 091812	1
12	16	PREOL 121816	1
16	19	PREOL 161819	1



Enchufe para tubo de obturación 90°

T1

Paso (mm)	Para tubo Ø int. (mm)	Referencia	Emba.
6	8	PREOL 061808RE	1
9	10	PREOL 091810RE	1
9	12	PREOL 091812RE	1



Enchufe rosca hembra de obturación 90°

T1

Paso (mm)	Rosca hembra BSPP	Referencia	Emba.
6	G 1/4	PREOL 061101RE	1
9	G 3/8	PREOL 091102RE	1
12	G 1/2	PREOL 121103RE	1



Enchufe para tubo de obturación 135°

T1

Paso (mm)	Para tubo Ø int. (mm)	Referencia	Emba.
6	8	PREOL 061808RO	1



CONECTORES PREOL

Conector rosca macho con obturador

T1

	Paso (mm)	Rosca macho BSPP	Referencia	Emba.
	6	G 1/8	PREOL 067150	1
	6	G 1/4	PREOL 067151	1
	9	G 1/4	PREOL 097151	1
	9	G 3/8	PREOL 097152	1
	9	G 1/2	PREOL 097153	1
	12	G 3/8	PREOL 127152	1
	12	G 1/2	PREOL 127153	1
	12	G 3/4	PREOL 127154	1
	16	G 3/4	PREOL 167154	1

Conector rosca macho de paso libre

T1

	Paso (mm)	Rosca macho	Referencia	Emba.
	6	R 1/8	PREOL 066160	1
	6	R 1/4	PREOL 066161	1
	9	R 1/4	PREOL 096161	1
	9	R 3/8	PREOL 096162	1
	9	G 1/2	PREOL 096153	1
	12	R 3/8	PREOL 126162	1
	12	R 1/2	PREOL 126163	1
	12	G 3/4	PREOL 126154	1
	16	R 3/4	PREOL 166164	1

Conector rosca hembra con obturador

T1

	Paso (mm)	Rosca hembra BSPP	Referencia	Emba.
	9	G 1/4	PREOL 097101	1

Conector rosca hembra de paso libre

T1

	Paso (mm)	Rosca hembra BSPP	Referencia	Emba.
	6	G 1/4	PREOL 066101	1
	9	G 1/4	PREOL 096101	1
	9	G 3/8	PREOL 096102	1
	12	G 1/2	PREOL 126103	1
	16	G 3/4	PREOL 166104	1

Conector de paso libre para tubo

T1

	Paso (mm)	Para tubo Ø int. (mm)	Referencia	Emba.
	16	19	PREOL 166819	1

ENCHUFES AUTOMÁTICOS PARA CIRCUITOS DE AGUA

Enchufe rosca hembra de paso libre

T1

	Rosca hembra BSPP	Referencia	Emba.
	G 1/2	ELS 090103	5
	G 3/4	ELS 090104	5
	G 1	ELS 090105	5

Enchufe rosca macho de paso libre

T1

	Rosca macho BSPP	Referencia	Emba.
	G 1/2	ELS 090153	5
	G 3/4	ELS 090154	5

Enchufe para tubo de paso libre

T1

	Para tubo Ø int. (mm)	Referencia	Emba.
	13	ELS 090813	5
	15	ELS 090815	5
	19	ELS 090819	5

Enchufe rosca hembra de obturación

T1

	Rosca hembra BSPP	Referencia	Emba.
	G 1/2	ELS 091103	5
	G 3/4	ELS 091104	5
	G 1	ELS 091105	5

Enchufe rosca macho de obturación

T1

	Rosca macho BSPP	Referencia	Emba.
	G 1/2	ELS 091153	5
	G 3/4	ELS 091154	5

ENCHUFES AUTOMÁTICOS PARA CIRCUITOS DE AGUA

Enchufe para tubo de obturación

T1

Para tubo Ø int. (mm)	Referencia	Emba.
13	ELS 091813	5
15	ELS 091815	5
19	ELS 091819	5



Enchufe pasatabiques de obturación

T1

Rosca macho BSPP	Espesor del tabique (mm)	Ø de taladrado (mm)	Referencia	Emba.
G 3/4	20	28	ELS 092154	1

Enchufe semi-automático para terminal de distribución de agua. Pasatabiques



Kit de conexión rapido

T1

Para tubo Ø int. (mm)	Referencia	Emba.
13	ELS KITBP13	1
15	ELS KITBP15	1
19	ELS KITBP19	1

Incluye :
 - 1 enchufe para tubo de obturación
 - 2 conectores rosca hembra G 3/4 BSPP
 - 1 tetón doble rosca macho G 3/4 x G 1/2 BSPP
 - 1 prolongador G 3/4 macho x G 1 hembra BSPP
 - 2 abrazaderas de orejas para tubos



Junta plana para enchufe ELS

T1

Compatibilidad	Referencia	Emba.
Junta plana para enchufe ELS Rosca G 3/4	ELS JP12	10
Junta plana para enchufe ELS Rosca G 3/4	ELS JP34	10



CONECTORES PARA ENCHUFES DE AGUA

Conector rosca hembra

T1

Rosca hembra BSPP	Referencia	Emba.
G 1/2	ELP 096103	10
G 3/4	ELP 096104	10
G 1	ELP 096105	10



Conector rosca macho

T1

Rosca macho BSPP	Referencia	Emba.
G 1/2	ELP 096153	10
G 3/4	ELP 096154	10



Conector rosca macho de obturación

T1

Rosca macho BSPP	Referencia	Emba.
G 3/4	ELP 097154	1



Conector para tubos

T1

Para tubo Ø int. (mm)	Referencia	Emba.
13	ELP 096813	10
15	ELP 096815	10
19	ELP 096819	10



Junta tórica para conector ELP

T1

Dénominación	Referencia	Emba.
Junta tórica para conector ELP	ELP JT	10



CONECTORES PARA ENCHUFES DE AGUA

Conector doble de enlace para enchufes

T1

Dénominación	Referencia	Emba.
Doble para 2 enchufes	ELP 096002	1



Conector triple de enlace para enchufes

T1

Dénominación	Referencia	Emba.
Triple para 3 enchufes	ELP 096003	1



Distribuidor 2 direcciones con válvulas de corte

T1

Rosca hembra BSPP	Referencia	Emba.
G 1/2	ELP 098103	1
G 3/4	ELP 098104	1



Forro

T1

Rosca hembra BSPP	Rosca macho BSPP	Referencia	Emba.
G 1/2	G 3/4	EFO 3412	1



Unión rosca macho cilíndrico

T1

Rosca macho BSPP	Para tubo Ø int. (mm)	Referencia	Emba.
G 3/4	13	EFT 3413	1
G 3/4	15	EFT 3415	1
G 3/4	19	EFT 3419	1



ENCHUFES EXPRESS

Enchufe express cilíndrico rosca macho

T2

Rosca macho BSPP	Referencia	Emba.
G 1/4	EXP M813	1
G 3/8	EXP M1217	1
G 1/2	EXP M1521	1
G 3/4	EXP M2027	1
G 1	EXP M2634	1
G 1 1/4	EXP M3342	1



Enchufe express cilíndrico rosca hembra

T2

Rosca hembra BSPP	Referencia	Emba.
G 1/4	EXP F813	1
G 3/8	EXP F1217	1
G 1/2	EXP F1521	1
G 3/4	EXP F2027	1
G 1	EXP F2634	1
G 1 1/4	EXP F3342	1



Enchufe express para tubo

T2

Para tubo Ø int. (mm)	Referencia	Emba.
7	EXP 7	1
8	EXP 8	1
9	EXP 9	1
10	EXP 10	1
11	EXP 11	1
13	EXP 13	1
16	EXP 16	1
19	EXP 19	1
22	EXP 22	1
25	EXP 25	1



ENCHUFES EXPRESS

Tapón

T2

Dénominación	Referencia	Emba.
Tapón	EXP BRE	1



Abrazaderas de apriete de seguridad (Acero galvanizado)

T2

Para tubo Ø ext. (mm)	Referencia	Emba.
14 - 16	CSS 15	1
16 - 18	CSS 17	1
19 - 21	CSS 20	1
22 - 24	CSS 23	1
25 - 27	CSS 26	1
28 - 30	CSS 29	1
31 - 33	CSS 32	1
34 - 36	CSS 36	1
37 - 39	CSS 38	1
41 - 43	CSS 42	1



Piezas sueltas para enchufes express

T2

Dénominación	Referencia	Emba.
Junta de caucho negra (agua)	EXP JCN	100
Junta de neopreno roja	EXP JNR	100



CONJUNTOS COMPLETOS EN BLISTER PARA INSTALACIONES DE SOLDADURA

Enchufes de seguridad para atornillar en manorreductor y conectores

T1

Entrada (Salida manorreductor)	Salida para tubo Ø (mm)	Referencia	Emba.
M16 x 1,5	10 x 17	SIK 10316S3	1

Conjunto para protección de las botellas.
El kit incluye :

2 enchufes + 2 conectores,
2 abrazaderas de orejas
Función : antirretroceso de llama y de gas
Función de parada térmica de caudal
Función de conexión rápida

La gama ISOFLAM es conforme a los :

- Dispositivos de seguridad conformes a las normas :
 - * Internacionales : ISO 5175
 - * Europeas : EN 730
- Dispositivos de conexión conformes a las normas :
 - * Internacionales : ISO 7289
 - * Europeas : EN 5611



Enchufes de seguridad y conectores para tubos

T1

Salida para tubo Ø (mm)	Entrada salida manorreductor/ Ø tubo (mm)	Referencia	Emba.
6 x 12	6 x 12	SIK 0606	1
6 x 12	10 x 17	SIK 1006	1
10 x 17	10 x 17	SIK 1010	1

Conjunto para protección del soldador.
El kit incluye :

2 enchufes + 2 conectores,
4 abrazaderas de orejas
Función : antirretroceso de llama y de gas
Función de parada térmica de caudal
Función de conexión rápida

La gama ISOFLAM es conforme a los :

- Dispositivos de seguridad conformes a las normas :
 - * Internacionales : ISO 5175
 - * Europeas : EN 730
- Dispositivos de conexión conformes a las normas :
 - * Internacionales : ISO 7289
 - * Europeas : EN 5611



CONJUNTOS COMPLETOS EN BLISTER PARA INSTALACIONES DE SOLDADURA

Enchufes y conectores dúo de seguridad

T1

Salida para tubo Ø (mm)	Entrada salida manorreductor/ Ø tubo (mm)	Referencia	Emba.
6 x 12	6 x 12	SIK 0606DS	1
6 x 12	10 x 17	SIK 1006DS	1
10 x 17	10 x 17	SIK 1010DS	1

Conjunto para protección del soldador.
El kit incluye :

2 enchufes + 2 conectores,
4 abrazaderas de orejas
Función : antirretroceso de llama y de gas
Función de conexión rápida

La gama ISOFLAM es conforme a los :

- Dispositivos de seguridad conformes a las normas :
 - * Internacionales : ISO 5175
 - * Europeas : EN 730
- Dispositivos de conexión conformes a las normas :
 - * Internacionales : ISO 7289
 - * Europeas : EN 5611



CONJUNTOS COMPLETOS EN BLISTER PARA INSTALACIONES DE SOLDADURA

Enchufes y conectores mono para prolongador

T1

Salida para tubo Ø (mm)	Entrada salida manorreductor/ Ø tubo (mm)	Referencia	Emba.
6 x 12	6 x 12	SIK 0606MR	1
6 x 12	10 x 17	SIK 1006MR	1
10 x 17	10 x 17	SIK 1010MR	1

Conjunto de conexión de paso libre para prolongador.
El kit incluye :

2 enchufes + 2 conectores,
4 abrazaderas de orejas.
Función de conexión rápida

La gama ISOFLAM es conforme a los :

- Dispositivos de seguridad conformes a las normas :
 - * Internacionales : ISO 5175
 - * Europeas : EN 730
- Dispositivos de conexión conformes a las normas :
 - * Internacionales : ISO 7289
 - * Europeas : EN 5611



Enchufes y conectores dúo para prolongador

T1

Salida para tubo Ø (mm)	Entrada salida manorreductor/ Ø tubo (mm)	Referencia	Emba.
6 x 12	6 x 12	SIK 0606DR	1
6 x 12	10 x 17	SIK 1006DR	1
10 x 17	10 x 17	SIK 1010DR	1

Conjunto de conexión de paso libre para prolongador.
El kit incluye :

2 enchufes + 2 conectores,
4 abrazaderas de orejas.
Función de conexión rápida

La gama ISOFLAM es conforme a los :

- Dispositivos de seguridad conformes a las normas :
 - * Internacionales : ISO 5175
 - * Europeas : EN 730
- Dispositivos de conexión conformes a las normas :
 - * Internacionales : ISO 7289
 - * Europeas : EN 5611



ENCHUFES Y CONECTORES DUO PARA SOLDADURA

Enchufes prolongador Dúo

T1

Para tubo Ø int. (mm)	Referencia	Emba.
6	SIJ 061806K	1
10	SIJ 061810K	1

Función de conexión rápida
Oxígeno y acetileno

La gama ISOFLAM es conforme a los :

- Dispositivos de seguridad conformes a las normas :
 - * Internacionales : ISO 5175
 - * Europeas : EN 730
- Dispositivos de conexión conformes a las normas :
 - * Internacionales : ISO 7289
 - * Europeas : EN 5611

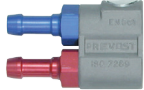

ENCHUFES Y CONECTORES DUO PARA SOLDADURA

Conectores Dúo de seguridad

T1

Para tubo Ø int. (mm)	Referencia	Emba.
6	SIJ 066806S2K	1
10	SIJ 066810S2K	1

Función : antirretroceso de llama y de gas
Función de conexión rápida
Oxígeno y acetileno



La gama ISOFLAM es conforme a los :
- Dispositivos de seguridad conformes a las normas :
* Internacionales : ISO 5175
* Europeas : EN 730
- Dispositivos de conexión conformes a las normas :
* Internacionales : ISO 7289
* Europeas : EN 5611

Conectores dúo de paso libre

T1

Para tubo Ø int. (mm)	Referencia	Emba.
6	SIJ 066806K	1
10	SIJ 066810K	1

La gama ISOFLAM es conforme a los :
- Dispositivos de seguridad conformes a las normas :
* Internacionales : ISO 5175
* Europeas : EN 730
- Dispositivos de conexión conformes a las normas :
* Internacionales : ISO 7289
* Europeas : EN 5611



ENCHUFES Y CONECTORES MONO DE SEGURIDAD PARA SOLDADURA

Enchufe para protección de las botellas

T1

Rosca hembra	Referencia	Emba.
M16 x 1,5	SIC 061316S3	1
G 3/8	SIC 061102S3	1

Función : antirretroceso de llama y de gas
Función de parada térmica de caudal
Función de conexión rápida
Oxígeno y acetileno



La gama ISOFLAM es conforme a los :
- Dispositivos de seguridad conformes a las normas :
* Internacionales : ISO 5175
* Europeas : EN 730
- Dispositivos de conexión conformes a las normas :
* Internacionales : ISO 7289
* Europeas : EN 5611

ENCHUFES Y CONECTORES MONO DE SEGURIDAD PARA SOLDADURA

Conector de paso libre para tubo

T1

Para tubo Ø int. (mm)	Referencia	Emba.
6	SIC 066806K	1
10	SIC 066810K	1

Función de conexión rápida
Oxígeno y acetileno

La gama ISOFLAM es conforme a los :
- Dispositivos de seguridad conformes a las normas :
* Internacionales : ISO 5175
* Europeas : EN 730
- Dispositivos de conexión conformes a las normas :
* Internacionales : ISO 7289
* Europeas : EN 5611



Enchufe para protección del soldador

T1

Para tubo Ø int. (mm)	Referencia	Emba.
6	SIC 061806S2K	1
10	SIC 061810S2K	1

Función : antirretroceso de llama y de gas
Función de conexión rápida
Oxígeno y acetileno

La gama ISOFLAM es conforme a los :
- Dispositivos de seguridad conformes a las normas :
* Internacionales : ISO 5175
* Europeas : EN 730
- Dispositivos de conexión conformes a las normas :
* Internacionales : ISO 7289
* Europeas : EN 5611



Enchufe prolongador

T1

Para tubo Ø int. (mm)	Referencia	Emba.
6	SIC 061806K	1
10	SIC 061810K	1

Función de conexión rápida
Oxígeno y acetileno

La gama ISOFLAM es conforme a los :
- Dispositivos de seguridad conformes a las normas :
* Internacionales : ISO 5175
* Europeas : EN 730
- Dispositivos de conexión conformes a las normas :
* Internacionales : ISO 7289
* Europeas : EN 5611



ENCHUFES Y CONECTORES MONO DE SEGURIDAD PARA SOLDADURA

Interceptor para montaje manguitos

T1

Entrada para tubo Ø int. (mm)	Salida para tubo Ø (mm)	Referencia	Emba.
6	6	SIC 069806806K	1
10	6	SIC 069810806K	1
10	10	SIC 069810810K	1

Función : antirretroceso de llama y de gas Oxígeno y acetileno

La gama ISOFLAM es conforme a los :
 - Dispositivos de seguridad conformes a las normas :
 * Internacionales : ISO 5175
 * Europeas : EN 730
 - Dispositivos de conexión conformes a las normas :
 * Internacionales : ISO 7289
 * Europeas : EN 5611



ENROLLADORES PARA TUBO DE SOLDADURA

Serie DGO - Tubos emparejados sin enchufe de seguridad ISOFLAM

T2

Ø int./ext. (mm)	Long. (m)	Referencia	Emba.
10 x 17	15	DGO 10150A	1

Salida :
 Oxígeno : G 3/8 hembra azul
 Acetileno : G 3/8 hembra rojo
 La gama ISOFLAM es conforme a los :
 - Dispositivos de seguridad conformes a las normas :
 * Internacionales : ISO 5175
 * Europeas : EN 730
 - Dispositivos de conexión conformes a las normas :
 * Internacionales : ISO 7289
 * Europeas : EN 5611



Serie DGO - Tubos emparejados con enchufe de seguridad ISOFLAM

T2

Ø int./ext. (mm)	Long. (m)	Referencia	Emba.
10 x 17	15	DGO 1015SIC	1

Salida :
 Oxígeno : enchufe protección soldador SIO 061810S2
 Acetileno : enchufe protección soldador SIA 061810S2
 La gama ISOFLAM es conforme a los :
 - Dispositivos de seguridad conformes a las normas :
 * Internacionales : ISO 5175
 * Europeas : EN 730
 - Dispositivos de conexión conformes a las normas :
 * Internacionales : ISO 7289
 * Europeas : EN 5611



ENCHUFES HIDRÁULICOS ISO 6150 A - OBTURACIÓN DE CHAPAleta

Enchufes hidráulicos ISO 6150 A

T7

Rosca hembra	Ø nominal (mm)	Referencia	Emba.
G 1/4	6	HCA 061101	1
G 3/8	10	HCA 101102	1
G 1/2	13	HCA 131103	1
M22 x 1,5	13	HCA 131221	1
G 3/4	20	HCA 201104	1
G 1	25	HCA 251105	1

Tapones de protección para enchufes hidráulicos : referirse al final del capítulo



Conectores hidráulicos ISO 6150 A

T7

Rosca hembra	Ø nominal (mm)	Referencia	Emba.
G 1/4	6	HCA 066101	1
G 3/8	10	HCA 106102	1
G 1/2	13	HCA 136103	1
M22 x 1,5	13	HCA 136221	1
G 3/4	20	HCA 206104	1
G 1	25	HCA 256105	1

Tapones de protección para enchufes hidráulicos : referirse al final del capítulo



ENCHUFES HIDRÁULICOS "PUSH PULL" ISO 6150 A - OBTURACIÓN DE CHAPAleta

Enchufes hidráulicos "Push Pull" ISO 6150 A

T7

Rosca hembra	Ø nominal (mm)	Referencia	Emba.
G 1/2	13	HPA 131103	1
M 22 x 1,5	13	HPA 131221	1

Tapones de protección para enchufes hidráulicos : referirse al final del capítulo



Conectores hidráulicos ISO 6150 A

T7

Rosca hembra	Ø nominal (mm)	Referencia	Emba.
G 1/4	6	HCA 066101	1
G 3/8	10	HCA 106102	1
G 1/2	13	HCA 136103	1
M22 x 1,5	13	HCA 136221	1
G 3/4	20	HCA 206104	1
G 1	25	HCA 256105	1

Tapones de protección para enchufes hidráulicos : referirse al final del capítulo



ENCHUFES HIDRÁULICOS ISO 6150 B - OBTURACIÓN DE CHAPALETA

Enchufes hidráulicos ISO 6150 B

T7

Rosca hembra BSPP	Ø nominal (mm)	Referencia	Emba.
G 1/4	6	HCIB 061101	1
G 3/8	10	HCIB 101102	1
G 1/2	13	HCIB 131103	1
G 3/4	19	HCIB 201104	1
G 1	25	HCIB 251105	1

Conectores hidráulicos ISO 6150 B

T7

Rosca hembra BSPP	Ø nominal (mm)	Referencia	Emba.
G 1/4	6	HCIB 066101	1
G 3/8	10	HCIB 106102	1
G 1/2	13	HCIB 136103	1
G 3/4	19	HCIB 206104	1
G 1	25	HCIB 256105	1

ENCHUFES HIDRÁULICOS ANTI-CONTAMINACIÓN CARAS PLANAS

Enchufes hidráulicos - Caras planas

T7

Rosca hembra BSPP	Ø nominal (mm)	Referencia	Emba.
G 1/4	6	HFP 061101	1
G 3/8	13	HFP 131102	1
G 1/2	13	HFP 131103	1
G 1/2	20	HFP 201103	1
G 3/4	20	HFP 201104	1
G 3/4	25	HFP 251104	1
G 1	25	HFP 251105	1

Tapones de protección para enchufes hidráulicos : referirse al final del capítulo

Conectores hidráulicos - Caras planas

T7

Rosca hembra BSPP	Ø nominal (mm)	Referencia	Emba.
G 1/4	6	HFP 066101	1
G 3/8	13	HFP 136102	1
G 1/2	13	HFP 136103	1
G 1/2	20	HFP 206103	1
G 3/4	20	HFP 206104	1
G 3/4	25	HFP 256104	1
G 1	25	HFP 256105	1

Tapones de protección para enchufes hidráulicos : referirse al final del capítulo

ENCHUFES HIDRÁULICOS INTERCAMBIABLES OBTURACIÓN POR BOLA

Enchufes hidráulicos intercambiables - obturación por bola

T7

Rosca hembra BSPP	Ø nominal (mm)	Referencia	Emba.
G 1/4	6	HBG 061101	1
G 3/8	10	HBG 101102	1
G 1/2	13	HBG 131103	1
G 3/4	20	HBG 201104	1

Tapones de protección para enchufes hidráulicos : referirse al final del capítulo

Conectores hidráulicos intercambiables - obturación por bola

T7

Rosca hembra BSPP	Ø nominal (mm)	Referencia	Emba.
G 1/4	6	HBG 066101	1
G 3/8	10	HBG 106102	1
G 1/2	13	HBG 136103	1
G 3/4	20	HBG 206104	1

Tapones de protección para enchufes hidráulicos : referirse al final del capítulo

ENCHUFES HIDRÁULICOS INTERCAMBIABLES OBTURACIÓN DE CHAPALETA

Enchufes hidráulicos intercambiables - Obturación de chapaleta

T7

Rosca hembra BSPP	Ø nominal (mm)	Referencia	Emba.
G 1/4	6	HCG 061101	1
G 3/8	10	HCG 101102	1
G 3/4	20	HCG 201104	1

Tapones de protección para enchufes hidráulicos : referirse al final del capítulo

Conectores hidráulicos intercambiables - Obturación de chapaleta

T7

Entrada rosca hembra BSPP	Ø nominal (mm)	Referencia	Emba.
G 1/4	6	HCG 066101	1
G 3/8	10	HCG 106102	1
G 3/4	20	HCG 206104	1

Tapones de protección para enchufes hidráulicos : referirse al final del capítulo

ENCHUFES HIDRÁULICOS PARA ATORNILLAR ALTA PRESIÓN

Enchufes hidráulicos para atornillar - alta presión

T7

Rosca macho NPT	Ø nominal (mm)	Referencia	Emba.
1/4	6	HBC 061251	1
3/8	10	HBC 101252	1



Conectores hidráulicos para atornillar - alta presión

T7

Rosca macho NPT	Ø nominal (mm)	Referencia	Emba.
1/4	6	HBC 066201	1
3/8	10	HBC 106202	1



VÁLVULAS AGRICOLAS PARA ATORNILLAR

Enchufe de válvula agrícola

T7

Rosca hembra	Ø nominal (mm)	Referencia	Emba.
M18 x 1,5	13	HVV 131181	1



Conector de válvula agrícola

T7

Rosca hembra	Ø nominal (mm)	Referencia	Emba.
M18 x 1,5	13	HVV 136181	1
Tapones de protección para enchufes hidráulicos : referirse al final del capítulo			



TAPONES DE PROTECCIÓN PARA ENCHUFE HIDRÁULICO

VÁLVULAS HIDRÁULICOS DE FRENADO

Enchufe de válvula de frenado

T7

Rosca hembra	Ø nominal (mm)	Referencia	Emba.
M18 x 1,5	13	HVF 131181	1



Conector de válvula de frenado

T7

Rosca hembra	Ø nominal (mm)	Referencia	Emba.
M18 x 1,5	13	HVF 136181	1
Tapones de protección para enchufes hidráulicos : referirse al final del capítulo			



Tapones para enchufes

T7

Ø nominal (mm)	Para enchufe (Serie:)	Referencia	Emba.
6	HCA	HBP 061A	1
10	HCA	HBP 101A	1
13	HCA	HBP 131A	1
13	HPA	HBP 131PP	1
6	HCG - HBG	HBP 061G	1
10	HCG - HBG	HBP 101G	1
13	HFP	HBP 131FP	1
20	HFP	HBP 201FP	1
13	HVF	HBP 131VF	1
13	HVV	HBP 131VV	1



Tapones para conectores

T7

Ø nominal (mm)	Para conector (Serie:)	Referencia	Emba.
6	HCA	HBP 066A	1
10	HCA	HBP 106A	1
13	HCA	HBP 136A	1
13	HPA	HBP 136PP	1
6	HCG - HBG	HBP 066G	1
10	HCG - HBG	HBP 106G	1
13	HFP	HBP 136FP	1
20	HFP	HBP 206FP	1



RACORES DE ACERO ALTA PRESIÓN

Racor hidráulico - HNJ

T7

Rosca macho NPT	Rosca (JIC 37°)	Referencia	Emba.
1/8	7/16	HNJ 250716	1
1/8	1/2	HNJ 25012	1
1/4	7/16	HNJ 251716	1
1/4	1/2	HNJ 25112	1
1/4	9/16	HNJ 251916	1
1/4	3/4	HNJ 25134	1
3/8	7/16	HNJ 252716	1
3/8	1/2	HNJ 25212	1
3/8	9/16	HNJ 252916	1
3/8	3/4	HNJ 25234	1
3/8	7/8	HNJ 25278	1
1/2	9/16	HNJ 253916	1
1/2	3/4	HNJ 25334	1
1/2	7/8	HNJ 25378	1
1/2	3/4	HNJ 25434	1

RACORES DE ACERO ALTA PRESIÓN

Racor hidráulico - HGB

T7

Rosca macho BSPT	Rosca macho BSPP	Referencia	Emba.
R 1/8	G 1/8	HGB 1818	1
R 1/8	G 1/4	HGB 1814	1
R 1/4	G 1/8	HGB 1418	1
R 1/4	G 1/4	HGB 1414	1
R 1/4	G 3/8	HGB 1438	1
R 3/8	G 1/4	HGB 3814	1
R 3/8	G 3/8	HGB 3838	1
R 3/8	G 1/2	HGB 3812	1
R 1/2	G 3/8	HGB 1238	1
R 1/2	G 1/2	HGB 1212	1
R 1/2	G 3/4	HGB 1234	1
R 3/4	G 3/4	HGB 3434	1
R 3/4	G 1	HGB 3401	1
R 1	G 1	HGB 0101	1

Racor hidráulico - HDD

T7

Rosca macho (DIN 3852-1)	Rosca macho (DIN 3852-1)	Referencia	Emba.
M14 x 1,5	M14 x 1,5	HDD 141	1
M16 x 1,5	M16 x 1,5	HDD 161	1
M18 x 1,5	M18 x 1,5	HDD 181	1
M22 x 1,5	M22 x 1,5	HDD 221	1
M26 x 1,5	M26 x 1,5	HDD 261	1
M30 x 1,5	M30 x 1,5	HDD 301	1

Racor hidráulico - HBB

T7

Rosca macho BSPP	Rosca macho BSPP	Referencia	Emba.
G 1/8	G 1/8	HBB 1818	1
G 1/8	G 1/4	HBB 1814	1
G 1/4	G 1/4	HBB 1414	1
G 1/4	G 3/8	HBB 1438	1
G 3/8	G 3/8	HBB 3838	1
G 3/8	G 1/2	HBB 3812	1
G 1/2	G 1/2	HBB 1212	1
G 1/2	G 3/4	HBB 1234	1
G 5/8	G 5/8	HBB 5858	1
G 3/4	G 3/4	HBB 3434	1
G 3/4	G 1	HBB 3401	1
G 1	G 1	HBB 0101	1

Racor hidráulico - HGD

T7

Rosca macho BSPT	Rosca macho (DIN 3852-1)	Referencia	Emba.
R 1/4	M14 x 1,5	HGD 14141	1
R 1/4	M16 x 1,5	HGD 14161	1
R 3/8	M16 x 1,5	HGD 38161	1
R 3/8	M18 x 1,5	HGD 38181	1
R 1/2	M18 x 1,5	HGD 12181	1
R 1/2	M22 x 1,5	HGD 12221	1
R 1/2	M26 x 1,5	HGD 12261	1
R 3/4	M26 x 1,5	HGD 34261	1
R 3/4	M30 x 1,5	HGD 34301	1
R 1	M30 x 1,5	HGD 01301	1

Racor hidráulico - HNB

T7

Rosca macho NPT	Rosca macho BSPP	Referencia	Emba.
1/8	G 1/8	HNB 25018	1
1/8	G 1/4	HNB 25014	1
1/4	G 1/8	HNB 25118	1
1/4	G 1/4	HNB 25114	1
1/4	G 3/8	HNB 25138	1
3/8	G 1/4	HNB 25214	1
3/8	G 3/8	HNB 25238	1
3/8	G 1/2	HNB 25212	1
1/2	G 3/8	HNB 25338	1
1/2	G 1/2	HNB 25312	1
1/2	G 3/4	HNB 25334	1
3/4	G 1/2	HNB 25412	1
3/4	G 3/4	HNB 25434	1
1	G 1	HNB 25401	1
3/4	G 3/4	HNB 25534	1
1	G 1	HNB 25501	1
1 1/4	G 1 1/4	HNB 25642	1
1 1/2	G 1 1/2	HNB 25749	1
2	G 2	HNB 25860	1

Piezas de conexión



Enchufes instantáneos CONEX	47 - 70
Enchufes de compresión y de olivetas RB / RO	71 - 72
Piezas de conexión	73 - 83
Válvulas	83 - 84
Accesorios de línea y silenciadores	84 - 85
Productos de estanqueidad	85

ENCHUFES INSTANTÁNEOS DE POLÍMERO

Enchufe recto macho cónico - RPD MR

T2

Rosca macho BSPT	Para tubo Ø ext. (mm)	Referencia	Emba.
R 1/8	4	RPD MR0400	10
R 1/4	4	RPD MR0401	10
R 1/8	5	RPD MR0500	10
R 1/4	5	RPD MR0501	10
R 3/8	5	RPD MR0502	10
R 1/2	5	RPD MR0503	10
R 1/8	6	RPD MR0600	10
R 1/4	6	RPD MR0601	10
R 3/8	6	RPD MR0602	10
R 1/2	6	RPD MR0603	10
R 1/8	8	RPD MR0800	10
R 1/4	8	RPD MR0801	10
R 3/8	8	RPD MR0802	10
R 1/2	8	RPD MR0803	10
R 1/8	10	RPD MR1000	10
R 1/4	10	RPD MR1001	10
R 3/8	10	RPD MR1002	10
R 1/2	10	RPD MR1003	10
R 1/4	12	RPD MR1201	5
R 3/8	12	RPD MR1202	5
R 1/2	12	RPD MR1203	5
R 3/8	14	RPD MR1402	5
R 1/2	14	RPD MR1403	5
R 3/8	16	RPD MR1602	5
R 1/2	16	RPD MR1603	5

Material : Latón niquelado



Enchufe recto macho cilíndrico - RPD MG

T2

Rosca macho BSPP	Para tubo Ø ext. (mm)	Referencia	Emba.
G 1/8	4	RPD MG0400	10
G 1/4	4	RPD MG0401	10
G 1/8	5	RPD MG0500	10
G 1/4	5	RPD MG0501	10
G 3/8	5	RPD MG0502	10
G 1/2	5	RPD MG0503	10
G 1/8	6	RPD MG0600	10
G 1/4	6	RPD MG0601	10
G 3/8	6	RPD MG0602	10
G 1/2	6	RPD MG0603	10
G 1/8	8	RPD MG0800	10
G 1/4	8	RPD MG0801	10
G 3/8	8	RPD MG0802	10
G 1/2	8	RPD MG0803	10
G 1/8	10	RPD MG1000	10
G 1/4	10	RPD MG1001	10
G 3/8	10	RPD MG1002	10
G 1/2	10	RPD MG1003	10
G 1/4	12	RPD MG1201	5
G 3/8	12	RPD MG1202	5
G 1/2	12	RPD MG1203	5
G 3/8	14	RPD MG1402	5
G 1/2	14	RPD MG1403	5
G 3/8	16	RPD MG1602	5
G 1/2	16	RPD MG1603	5

Material : Latón niquelado



ENCHUFES INSTANTÁNEOS DE POLÍMERO

Enchufe recto macho cilíndrico - RPD MG

T2

Rosca macho métrica	Para tubo Ø ext. (mm)	Referencia	Emba.
M5	4	RPD MG04M5	10
M5	5	RPD MG05M5	10
M5	6	RPD MG06M5	10

Material : Latón niquelado



Enchufe recto hembra cilíndrica - RPD FG

T2

Rosca hembra BSPP	Para tubo Ø ext. (mm)	Referencia	Emba.
G 1/8	4	RPD FG0400	10
G 1/4	4	RPD FG0401	10
G 1/8	5	RPD FG0500	10
G 1/4	5	RPD FG0501	10
G 3/8	5	RPD FG0502	10
G 1/2	5	RPD FG0503	10
G 1/8	6	RPD FG0600	10
G 1/4	6	RPD FG0601	10
G 3/8	6	RPD FG0602	10
G 1/2	6	RPD FG0603	10
G 1/8	8	RPD FG0800	10
G 1/4	8	RPD FG0801	10
G 3/8	8	RPD FG0802	10
G 1/2	8	RPD FG0803	10
G 1/8	10	RPD FG1000	10
G 1/4	10	RPD FG1001	10
G 3/8	10	RPD FG1002	10
G 1/2	10	RPD FG1003	10
G 1/4	12	RPD FG1201	5
G 3/8	12	RPD FG1202	5
G 1/2	12	RPD FG1203	5
G 3/8	14	RPD FG1402	5
G 1/2	14	RPD FG1403	5
G 3/8	16	RPD FG1602	5
G 1/2	16	RPD FG1603	5

Material : Latón niquelado



Enchufe recto hembra cilíndrica - RPD FG

T2

Rosca hembra métrica	Para tubo Ø ext. (mm)	Referencia	Emba.
M5	4	RPD FG04M5	1,65 10
M5	5	RPD FG05M5	1,65 10
M5	6	RPD FG06M5	1,65 10

Material : Latón niquelado



ENCHUFES INSTANTÁNEOS DE POLÍMERO

Enchufe recto pasamuros hembra cilíndrica - RPD TG T2

Rosca hembra BSPP	Para tubo Ø ext. (mm)	Referencia	Emba.
G 1/8	4	RPD TG0400	10
G 1/4	4	RPD TG0401	10
G 1/8	5	RPD TG0500	10
G 1/4	5	RPD TG0501	10
G 3/8	5	RPD TG0502	10
G 1/2	5	RPD TG0503	10
G 1/8	6	RPD TG0600	10
G 1/4	6	RPD TG0601	10
G 3/8	6	RPD TG0602	10
G 1/2	6	RPD TG0603	10
G 1/8	8	RPD TG0800	10
G 1/4	8	RPD TG0801	10
G 3/8	8	RPD TG0802	10
G 1/2	8	RPD TG0803	10
G 1/8	10	RPD TG1000	10
G 1/4	10	RPD TG1001	10
G 3/8	10	RPD TG1002	10
G 1/2	10	RPD TG1003	10
G 1/4	12	RPD TG1201	5
G 3/8	12	RPD TG1202	5
G 1/2	12	RPD TG1203	5
G 3/8	14	RPD TG1402	5
G 1/2	14	RPD TG1403	5
G 3/8	16	RPD TG1602	5
G 1/2	16	RPD TG1603	5

Material : Láton niquelado



Enchufe recto pasamuros hembra cilíndrica - RPD TG T2

Rosca hembra métrica	Para tubo Ø ext. (mm)	Referencia	Emba.
M5	4	RPD TG04M5	10
M5	5	RPD TG05M5	10
M5	6	RPD TG06M5	10

Material : Láton niquelado



ENCHUFES INSTANTÁNEOS DE POLÍMERO

Codo 90° macho cónico orientable - RPC MR T2

Rosca macho BSPT	Para tubo Ø ext. (mm)	Referencia	Emba.
R 1/8	4	RPC MR0400	10
R 1/4	4	RPC MR0401	10
R 1/8	5	RPC MR0500	10
R 1/4	5	RPC MR0501	10
R 3/8	5	RPC MR0502	10
R 1/2	5	RPC MR0503	10
R 1/8	6	RPC MR0600	10
R 1/4	6	RPC MR0601	10
R 3/8	6	RPC MR0602	10
R 1/2	6	RPC MR0603	10
R 1/8	8	RPC MR0800	10
R 1/4	8	RPC MR0801	10
R 3/8	8	RPC MR0802	10
R 1/2	8	RPC MR0803	10
R 1/8	10	RPC MR1000	10
R 1/4	10	RPC MR1001	10
R 3/8	10	RPC MR1002	10
R 1/2	10	RPC MR1003	10
R 1/4	12	RPC MR1201	5
R 3/8	12	RPC MR1202	5
R 1/2	12	RPC MR1203	5
R 3/8	14	RPC MR1402	5
R 1/2	14	RPC MR1403	5
R 3/8	16	RPC MR1602	5
R 1/2	16	RPC MR1603	5



Codo 90° macho cilíndrico orientable - RPC MG T2

Rosca macho BSPP	Para tubo Ø ext. (mm)	Referencia	Emba.
G 1/8	4	RPC MG0400	10
G 1/4	4	RPC MG0401	10
G 1/8	5	RPC MG0500	10
G 1/4	5	RPC MG0501	10
G 3/8	5	RPC MG0502	10
G 1/2	5	RPC MG0503	10
G 1/8	6	RPC MG0600	10
G 1/4	6	RPC MG0601	10
G 3/8	6	RPC MG0602	10
G 1/2	6	RPC MG0603	10
G 1/8	8	RPC MG0800	10
G 1/4	8	RPC MG0801	10
G 3/8	8	RPC MG0802	10
G 1/2	8	RPC MG0803	10
G 1/8	10	RPC MG1000	10
G 1/4	10	RPC MG1001	10
G 3/8	10	RPC MG1002	10
G 1/2	10	RPC MG1003	10
G 1/4	12	RPC MG1201	5
G 3/8	12	RPC MG1202	5
G 1/2	12	RPC MG1203	5
G 3/8	14	RPC MG1402	5
G 1/2	14	RPC MG1403	5
G 3/8	16	RPC MG1602	5
G 1/2	16	RPC MG1603	5



ENCHUFES INSTANTÁNEOS DE POLÍMERO

Codo 90° macho cilíndrico orientable - RPC MG

T2

Rosca macho métrica	Para tubo Ø ext. (mm)	Referencia	Emba.
M5	4	RPC MG04M5	10
M5	5	RPC MG05M5	10
M5	6	RPC MG06M5	10



Codo 90° macho cónico largo orientable - RPC LR

T2

Rosca macho BSPT	Para tubo Ø ext. (mm)	Referencia	Emba.
R 1/8	4	RPC LR0400	10
R 1/4	4	RPC LR0401	10
R 1/8	5	RPC LR0500	10
R 1/4	5	RPC LR0501	10
R 3/8	5	RPC LR0502	10
R 1/2	5	RPC LR0503	10
R 1/8	6	RPC LR0600	10
R 1/4	6	RPC LR0601	10
R 3/8	6	RPC LR0602	10
R 1/2	6	RPC LR0603	10
R 1/8	8	RPC LR0800	10
R 1/4	8	RPC LR0801	10
R 3/8	8	RPC LR0802	10
R 1/2	8	RPC LR0803	10
R 1/8	10	RPC LR1000	10
R 1/4	10	RPC LR1001	10
R 3/8	10	RPC LR1002	10
R 1/2	10	RPC LR1003	10
R 1/4	12	RPC LR1201	5
R 3/8	12	RPC LR1202	5
R 1/2	12	RPC LR1203	5
R 3/8	14	RPC LR1402	5
R 1/2	14	RPC LR1403	5
R 3/8	16	RPC LR1602	5
R 1/2	16	RPC LR1603	5



ENCHUFES INSTANTÁNEOS DE POLÍMERO

Codo 90° macho cilíndrico largo orientable - RPC LG

T2

Rosca macho BSPP	Para tubo Ø ext. (mm)	Referencia	Emba.
G 1/8	4	RPC LG0400	10
G 1/4	4	RPC LG0401	10
G 1/8	5	RPC LG0500	10
G 1/4	5	RPC LG0501	10
G 3/8	5	RPC LG0502	10
G 1/2	5	RPC LG0503	10
G 1/8	6	RPC LG0600	10
G 1/4	6	RPC LG0601	10
G 3/8	6	RPC LG0602	10
G 1/2	6	RPC LG0603	10
G 1/8	8	RPC LG0800	10
G 1/4	8	RPC LG0801	10
G 3/8	8	RPC LG0802	10
G 1/2	8	RPC LG0803	10
G 1/8	10	RPC LG1000	10
G 1/4	10	RPC LG1001	10
G 3/8	10	RPC LG1002	10
G 1/2	10	RPC LG1003	10
G 1/4	12	RPC LG1201	5
G 3/8	12	RPC LG1202	5
G 1/2	12	RPC LG1203	5
G 3/8	14	RPC LG1402	5
G 1/2	14	RPC LG1403	5
G 3/8	16	RPC LG1602	5
G 1/2	16	RPC LG1603	5



Codo 90° macho cilíndrico largo orientable - RPC LG

T2

Rosca macho métrica	Para tubo Ø ext. (mm)	Referencia	Emba.
M5	4	RPC LG04M5	10
M5	5	RPC LG05M5	10
M5	6	RPC LG06M5	10



ENCHUFES INSTANTÁNEOS DE POLÍMERO

Codo 90° hembra cilíndrica orientable - RPC FG

T2

Rosca hembra BSPP	Para tubo Ø ext. (mm)	Referencia	Emba.
G 1/8	4	RPC FG0400	10
G 1/4	4	RPC FG0401	10
G 1/8	5	RPC FG0500	10
G 1/4	5	RPC FG0501	10
G 3/8	5	RPC FG0502	10
G 1/2	5	RPC FG0503	10
G 1/8	6	RPC FG0600	10
G 1/4	6	RPC FG0601	10
G 3/8	6	RPC FG0602	10
G 1/2	6	RPC FG0603	10
G 1/8	8	RPC FG0800	10
G 1/4	8	RPC FG0801	10
G 3/8	8	RPC FG0802	10
G 1/2	8	RPC FG0803	10
G 1/8	10	RPC FG1000	10
G 1/4	10	RPC FG1001	10
G 3/8	10	RPC FG1002	10
G 1/2	10	RPC FG1003	10
G 1/4	12	RPC FG1201	5
G 3/8	12	RPC FG1202	5
G 1/2	12	RPC FG1203	5
G 3/8	14	RPC FG1402	5
G 1/2	14	RPC FG1403	5
G 3/8	16	RPC FG1602	5
G 1/2	16	RPC FG1603	5



Codo 90° hembra orientable cilíndrica - RPC FG

T2

Rosca hembra métrica	Para tubo Ø ext. (mm)	Referencia	Emba.
M5	4	RPC FG04M5	10
M5	5	RPC FG05M5	10
M5	6	RPC FG06M5	10



ENCHUFES INSTANTÁNEOS DE POLÍMERO

Codo 135° macho cónico orientable - RPQ MR

T2

Rosca macho BSPT	Para tubo Ø ext. (mm)	Referencia	Emba.
R 1/8	4	RPQ MR0400	10
R 1/4	4	RPQ MR0401	10
R 1/8	5	RPQ MR0500	10
R 1/4	5	RPQ MR0501	10
R 3/8	5	RPQ MR0502	10
R 1/2	5	RPQ MR0503	10
R 1/8	6	RPQ MR0600	10
R 1/4	6	RPQ MR0601	10
R 3/8	6	RPQ MR0602	10
R 1/2	6	RPQ MR0603	10
R 1/8	8	RPQ MR0800	10
R 1/4	8	RPQ MR0801	10
R 3/8	8	RPQ MR0802	10
R 1/2	8	RPQ MR0803	10
R 1/8	10	RPQ MR1000	10
R 1/4	10	RPQ MR1001	10
R 3/8	10	RPQ MR1002	10
R 1/2	10	RPQ MR1003	10
R 1/4	12	RPQ MR1201	5
R 3/8	12	RPQ MR1202	5
R 1/2	12	RPQ MR1203	5



Codo 135° macho cilíndrico orientable - RPQ MG

T2

Rosca macho BSPP	Para tubo Ø ext. (mm)	Referencia	Emba.
G 1/8	4	RPQ MG0400	10
G 1/4	4	RPQ MG0401	10
G 1/8	5	RPQ MG0500	10
G 1/4	5	RPQ MG0501	10
G 3/8	5	RPQ MG0502	10
G 1/2	5	RPQ MG0503	10
G 1/8	6	RPQ MG0600	10
G 1/4	6	RPQ MG0601	10
G 3/8	6	RPQ MG0602	10
G 1/2	6	RPQ MG0603	10
G 1/8	8	RPQ MG0800	10
G 1/4	8	RPQ MG0801	10
G 3/8	8	RPQ MG0802	10
G 1/2	8	RPQ MG0803	10
G 1/8	10	RPQ MG1000	10
G 1/4	10	RPQ MG1001	10
G 3/8	10	RPQ MG1002	10
G 1/2	10	RPQ MG1003	10
G 1/4	12	RPQ MG1201	5
G 3/8	12	RPQ MG1202	5
G 1/2	12	RPQ MG1203	5



ENCHUFES INSTANTÁNEOS DE POLÍMERO

Codo 135° macho cilíndrico orientable - RPQ MG

T2

Rosca macho métrica	Para tubo Ø ext. (mm)	Referencia	Emba.
M5	4	RPQ MG04M5	10
M5	5	RPQ MG05M5	10
M5	6	RPQ MG06M5	10



Unión orientable macho cónico - RPB MR

T2

Rosca macho BSPT	Para tubo Ø ext. (mm)	Referencia	Emba.
R 1/8	4	RPB MR0400	10
R 1/4	4	RPB MR0401	10
R 1/8	5	RPB MR0500	10
R 1/4	5	RPB MR0501	10
R 3/8	5	RPB MR0502	10
R 1/2	5	RPB MR0503	10
R 1/8	6	RPB MR0600	10
R 1/4	6	RPB MR0601	10
R 3/8	6	RPB MR0602	10
R 1/2	6	RPB MR0603	10
R 1/8	8	RPB MR0800	10
R 1/4	8	RPB MR0801	10
R 3/8	8	RPB MR0802	10
R 1/2	8	RPB MR0803	10
R 1/8	10	RPB MR1000	10
R 1/4	10	RPB MR1001	10
R 3/8	10	RPB MR1002	10
R 1/2	10	RPB MR1003	10
R 1/4	12	RPB MR1201	5
R 3/8	12	RPB MR1202	5
R 1/2	12	RPB MR1203	5
R 3/8	16	RPB MR1602	5
R 1/2	16	RPB MR1603	5



ENCHUFES INSTANTÁNEOS DE POLÍMERO

Unión orientable macho cilíndrico - RPB MG

T2

Rosca macho BSPP	Para tubo Ø ext. (mm)	Referencia	Emba.
G 1/8	4	RPB MG0400	10
G 1/4	4	RPB MG0401	10
G 1/8	5	RPB MG0500	10
G 1/4	5	RPB MG0501	10
G 3/8	5	RPB MG0502	10
G 1/2	5	RPB MG0503	10
G 1/8	6	RPB MG0600	10
G 1/4	6	RPB MG0601	10
G 3/8	6	RPB MG0602	10
G 1/2	6	RPB MG0603	10
G 1/8	8	RPB MG0800	10
G 1/4	8	RPB MG0801	10
G 3/8	8	RPB MG0802	10
G 1/2	8	RPB MG0803	10
G 1/8	10	RPB MG1000	10
G 1/4	10	RPB MG1001	10
G 3/8	10	RPB MG1002	10
G 1/2	10	RPB MG1003	10
G 1/4	12	RPB MG1201	5
G 3/8	12	RPB MG1202	5
G 1/2	12	RPB MG1203	5
G 3/8	16	RPB MG1602	5
G 1/2	16	RPB MG1603	5



Unión orientable macho cilíndrico - RPB MG

T2

Rosca macho métrica	Para tubo Ø ext. (mm)	Referencia	Emba.
M5	4	RPB MG04M5	10
M5	5	RPB MG05M5	10
M5	6	RPB MG06M5	10



ENCHUFES INSTANTÁNEOS DE POLÍMERO

Unión orientable hembra cilíndrica - RPB FG

T2

Rosca hembra BSPP	Para tubo Ø ext. (mm)	Referencia	Emba.
G 1/8	4	RPB FG0400	10
G 1/4	4	RPB FG0401	10
G 1/8	5	RPB FG0500	10
G 1/4	5	RPB FG0501	10
G 3/8	5	RPB FG0502	10
G 1/2	5	RPB FG0503	10
G 1/8	6	RPB FG0600	10
G 1/4	6	RPB FG0601	10
G 3/8	6	RPB FG0602	10
G 1/2	6	RPB FG0603	10
G 1/8	8	RPB FG0800	10
G 1/4	8	RPB FG0801	10
G 3/8	8	RPB FG0802	10
G 1/2	8	RPB FG0803	10
G 1/8	10	RPB FG1000	10
G 1/4	10	RPB FG1001	10
G 3/8	10	RPB FG1002	10
G 1/2	10	RPB FG1003	10
G 1/4	12	RPB FG1201	5
G 3/8	12	RPB FG1202	5
G 1/2	12	RPB FG1203	5
G 3/8	16	RPB FG1602	5
G 1/2	16	RPB FG1603	11,75 1



Unión orientable hembra cilíndrica - RPB FG

T2

Rosca hembra métrica	Para tubo Ø ext. (mm)	Referencia	Emba.
M5	4	RPB FG04M5	10
M5	5	RPB FG05M5	10
M5	6	RPB FG06M5	10



ENCHUFES INSTANTÁNEOS DE POLÍMERO

T macho cónico en el centro orientable - RPT CR

T2

Rosca macho BSPT	Para tubo Ø ext. (mm)	Referencia	Emba.
R 1/8	4	RPT CR0400	10
R 1/4	4	RPT CR0401	10
R 1/8	5	RPT CR0500	10
R 1/4	5	RPT CR0501	10
R 3/8	5	RPT CR0502	10
R 1/2	5	RPT CR0503	10
R 1/8	6	RPT CR0600	10
R 1/4	6	RPT CR0601	10
R 3/8	6	RPT CR0602	10
R 1/2	6	RPT CR0603	10
R 1/8	8	RPT CR0800	10
R 1/4	8	RPT CR0801	10
R 3/8	8	RPT CR0802	10
R 1/2	8	RPT CR0803	10
R 1/8	10	RPT CR1000	10
R 1/4	10	RPT CR1001	10
R 3/8	10	RPT CR1002	10
R 1/2	10	RPT CR1003	10
R 1/4	12	RPT CR1201	5
R 3/8	12	RPT CR1202	5
R 1/2	12	RPT CR1203	5
R 3/8	14	RPT CR1402	5
R 1/2	14	RPT CR1403	5
R 3/8	16	RPT CR1602	5
R 1/2	16	RPT CR1603	5



ENCHUFES INSTANTÁNEOS DE POLÍMERO

T macho cilíndrico en el centro orientable - RPT CG

T2

Rosca macho BSPP	Para tubo Ø ext. (mm)	Referencia	Emba.
G 1/8	4	RPT CG0400	10
G 1/4	4	RPT CG0401	10
G 1/8	5	RPT CG0500	10
G 1/4	5	RPT CG0501	10
G 3/8	5	RPT CG0502	10
G 1/2	5	RPT CG0503	10
G 1/8	6	RPT CG0600	10
G 1/4	6	RPT CG0601	10
G 3/8	6	RPT CG0602	10
G 1/2	6	RPT CG0603	10
G 1/8	8	RPT CG0800	10
G 1/4	8	RPT CG0801	10
G 3/8	8	RPT CG0802	10
G 1/2	8	RPT CG0803	10
G 1/8	10	RPT CG1000	10
G 1/4	10	RPT CG1001	10
G 3/8	10	RPT CG1002	10
G 1/2	10	RPT CG1003	10
G 1/4	12	RPT CG1201	5
G 3/8	12	RPT CG1202	5
G 1/2	12	RPT CG1203	5
G 3/8	14	RPT CG1402	5
G 1/2	14	RPT CG1403	5
G 3/8	16	RPT CG1602	5
G 1/2	16	RPT CG1603	5



ENCHUFES INSTANTÁNEOS DE POLÍMERO

T macho cónico lateral orientable - RPT AR

T2

Rosca macho BSPT	Para tubo Ø ext. (mm)	Referencia	Emba.
R 1/8	4	RPT AR0400	10
R 1/4	4	RPT AR0401	10
R 1/8	5	RPT AR0500	10
R 1/4	5	RPT AR0501	10
R 3/8	5	RPT AR0502	10
R 1/2	5	RPT AR0503	10
R 1/8	6	RPT AR0600	10
R 1/4	6	RPT AR0601	10
R 3/8	6	RPT AR0602	10
R 1/2	6	RPT AR0603	10
R 1/8	8	RPT AR0800	10
R 1/4	8	RPT AR0801	10
R 3/8	8	RPT AR0802	10
R 1/2	8	RPT AR0803	10
R 1/8	10	RPT AR1000	10
R 1/4	10	RPT AR1001	10
R 3/8	10	RPT AR1002	10
R 1/2	10	RPT AR1003	10
R 1/4	12	RPT AR1201	5
R 3/8	12	RPT AR1202	5
R 1/2	12	RPT AR1203	5
R 3/8	14	RPT AR1402	5
R 1/2	14	RPT AR1403	5
R 3/8	16	RPT AR1602	5
R 1/2	16	RPT AR1603	5



T macho cilíndrico en el centro orientable - RPT CG

T2

Rosca macho métrica	Para tubo Ø ext. (mm)	Referencia	Emba.
M5	4	RPT CG04M5	10
M5	5	RPT CG05M5	10
M5	6	RPT CG06M5	10



ENCHUFES INSTANTÁNEOS DE POLÍMERO

T macho cilíndrico lateral orientable - RPT AG

T2

Rosca macho BSPP	Para tubo Ø ext. (mm)	Referencia	Emba.
G 1/8	4	RPT AG0400	10
G 1/4	4	RPT AG0401	10
G 1/8	5	RPT AG0500	10
G 1/4	5	RPT AG0501	10
G 3/8	5	RPT AG0502	10
G 1/2	5	RPT AG0503	10
G 1/8	6	RPT AG0600	10
G 1/4	6	RPT AG0601	10
G 3/8	6	RPT AG0602	10
G 1/2	6	RPT AG0603	10
G 1/8	8	RPT AG0800	10
G 1/4	8	RPT AG0801	10
G 3/8	8	RPT AG0802	10
G 1/2	8	RPT AG0803	10
G 1/8	10	RPT AG1000	10
G 1/4	10	RPT AG1001	10
G 3/8	10	RPT AG1002	10
G 1/2	10	RPT AG1003	10
G 1/4	12	RPT AG1201	5
G 3/8	12	RPT AG1202	5
G 1/2	12	RPT AG1203	5
G 3/8	14	RPT AG1402	5
G 1/2	14	RPT AG1403	5
G 3/8	16	RPT AG1602	5
G 1/2	16	RPT AG1603	5



T macho cilíndrico lateral orientable - RPT AG

T2

Rosca macho métrica	Para tubo Ø ext. (mm)	Referencia	Emba.
M5	4	RPT AG04M5	10
M5	5	RPT AG05M5	10
M5	6	RPT AG06M5	10



ENCHUFES INSTANTÁNEOS DE POLÍMERO

Unión triple macho cilíndrico orientable - RPN MG

T2

Rosca macho BSPP	Para tubo Ø ext. (mm)	Referencia	Emba.
G 1/8	4	RPN MG0400	1
G 1/4	4	RPN MG0401	1
G 1/8	5	RPN MG0500	1
G 1/4	5	RPN MG0501	1
G 3/8	5	RPN MG0502	1
G 1/2	5	RPN MG0503	1
G 1/8	6	RPN MG0600	1
G 1/4	6	RPN MG0601	1
G 3/8	6	RPN MG0602	1
G 1/2	6	RPN MG0603	1
G 1/8	8	RPN MG0800	1
G 1/4	8	RPN MG0801	1
G 3/8	8	RPN MG0802	1
G 1/2	8	RPN MG0803	1



Unión triple macho cilíndrico orientable - RPN MG

T2

Rosca macho métrica	Para tubo Ø ext. (mm)	Referencia	Emba.
M5	4	RPN MG04M5	1
M5	5	RPN MG05M5	1
M5	6	RPN MG06M5	1



Unión triple macho cilíndrico para tubos desiguales orientable - RPN KG

T2

Rosca macho BSPP	Para tubo Ø ext (x1)	Para tubo Ø ext (x3)	Referencia	Emba.
G 1/8	6	4	RPN KG6400	1
G 1/4	8	4	RPN KG8401	1
G 1/4	8	6	RPN KG8601	1
G 3/8	10	8	RPN KG1082	1
G 1/2	10	8	RPN KG1083	1



ENCHUFES INSTANTÁNEOS DE POLÍMERO

Y macho cónico orientable - RPY MR

T2

Rosca macho BSPT	Para tubo Ø ext. (mm)	Referencia	Emba.
R 1/8	4	RPY MR0400	10
R 1/4	4	RPY MR0401	10
R 1/8	5	RPY MR0500	10
R 1/4	5	RPY MR0501	10
R 3/8	5	RPY MR0502	10
R 1/2	5	RPY MR0503	10
R 1/8	6	RPY MR0600	10
R 1/4	6	RPY MR0601	10
R 3/8	6	RPY MR0602	10
R 1/2	6	RPY MR0603	10
R 1/8	8	RPY MR0800	10
R 1/4	8	RPY MR0801	10
R 3/8	8	RPY MR0802	10
R 1/2	8	RPY MR0803	10
R 1/8	10	RPY MR1000	10
R 1/4	10	RPY MR1001	10
R 3/8	10	RPY MR1002	10
R 1/2	10	RPY MR1003	10
R 1/4	12	RPY MR1201	5
R 3/8	12	RPY MR1202	5
R 1/2	12	RPY MR1203	5
R 3/8	14	RPY MR1402	5
R 1/2	14	RPY MR1403	5
R 3/8	16	RPY MR1602	5
R 1/2	16	RPY MR1603	5



ENCHUFES INSTANTÁNEOS DE POLÍMERO

Y macho cilíndrico orientable - RPY MG

T2

Rosca macho BSPP	Para tubo Ø ext. (mm)	Referencia	Emba.
G 1/8	4	RPY MG0400	10
G 1/4	4	RPY MG0401	10
G 1/8	5	RPY MG0500	10
G 1/4	5	RPY MG0501	10
G 3/8	5	RPY MG0502	10
G 1/2	5	RPY MG0503	10
G 1/8	6	RPY MG0600	10
G 1/4	6	RPY MG0601	10
G 3/8	6	RPY MG0602	10
G 1/2	6	RPY MG0603	10
G 1/8	8	RPY MG0800	10
G 1/4	8	RPY MG0801	10
G 3/8	8	RPY MG0802	10
G 1/2	8	RPY MG0803	10
G 1/8	10	RPY MG1000	10
G 1/4	10	RPY MG1001	10
G 3/8	10	RPY MG1002	10
G 1/2	10	RPY MG1003	10
G 1/4	12	RPY MG1201	5
G 3/8	12	RPY MG1202	5
G 1/2	12	RPY MG1203	5
G 3/8	14	RPY MG1402	5
G 1/2	14	RPY MG1403	5
G 3/8	16	RPY MG1602	5
G 1/2	16	RPY MG1603	5



Y macho cilíndrico orientable - RPY MG

T2

Rosca macho métrica	Para tubo Ø ext. (mm)	Referencia	Emba.
M5	4	RPY MG04M5	10
M5	5	RPY MG05M5	10
M5	6	RPY MG06M5	10



ENCHUFES INSTANTÁNEOS DE POLÍMERO

Unión igual para tubo - RPU ET

T2

Para tubo Ø ext. (mm)	Referencia	Emba.
4	RPU ET0404	10
5	RPU ET0505	10
6	RPU ET0606	10
8	RPU ET0808	10
10	RPU ET1010	10
12	RPU ET1212	5
14	RPU ET1414	5
16	RPU ET1616	5



ENCHUFES INSTANTÁNEOS DE POLÍMERO

Reducción - RPR PT

T2

Para tubo Ø ext. (mm)	Enchufe Ø int. (mm)	Referencia	Emba.
4	5	RPR PT0504	10
4	6	RPR PT0604	10
4	8	RPR PT0804	10
6	8	RPR PT0806	10
6	10	RPR PT1006	10
8	10	RPR PT1008	10
8	12	RPR PT1208	10
10	12	RPR PT1210	10

Material : Láton niquelado



Unión para pasatabiques - RPU TT

T2

Para tubo Ø ext. (mm)	Referencia	Emba.
4	RPU TT0404	10
5	RPU TT0505	10
6	RPU TT0606	10
8	RPU TT0808	10
10	RPU TT1010	10
12	RPU TT1212	5
16	RPU TT1616	1

Material : Láton niquelado



Codo igual 90° - RPC ET

T2

Para tubo Ø ext. (mm)	Referencia	Emba.
4	RPC ET0404	10
5	RPC ET0505	10
6	RPC ET0606	10
8	RPC ET0808	10
10	RPC ET1010	10
12	RPC ET1212	5
14	RPC ET1414	5
16	RPC ET1616	5



Unión recta para tubos desiguales - RPU IT

T2

Para tubo Ø ext. (mm)	Para tubo Ø ext. (mm)	Referencia	Emba.
6	4	RPU IT0604	10
8	6	RPU IT0806	10
10	8	RPU IT1008	10
12	10	RPU IT1210	10
16	12	RPU IT1612	5



Codo 90° - RPC PT

T2

Para tubo Ø ext. (mm)	Enchufe Ø int. (mm)	Referencia	Emba.
4	4	RPC PT0404	10
5	5	RPC PT0505	10
6	6	RPC PT0606	10
8	8	RPC PT0808	10
10	10	RPC PT1010	10
12	12	RPC PT1212	5
14	14	RPC PT1414	5
16	16	RPC PT1616	5



ENCHUFES INSTANTÁNEOS DE POLÍMERO

Codo pasatabiques - RPC TT

T2

Para tubo Ø ext. (mm)	Referencia	Emba.
4	RPC TT0404	10
5	RPC TT0505	10
6	RPC TT0606	10
8	RPC TT0808	10
10	RPC TT1010	10
12	RPC TT1212	5
14	RPC TT1414	1
16	RPC TT1616	1



ENCHUFES INSTANTÁNEOS DE POLÍMERO

Y para tubos desiguales - RPY IT

T2

Para tubo Ø ext. (mm)	Para tubo Ø ext. (x2) (mm)	Referencia	Emba.
6	4	RPY IT0604	10
8	6	RPY IT0806	10
10	8	RPY IT1008	10
12	10	RPY IT1210	10
16	12	RPY IT1612	5



Codo 45° - RPQ PT

T2

Para tubo Ø ext. (mm)	Enchufe Ø int. (mm)	Referencia	Emba.
4	4	RPQ PT0404	10
5	5	RPQ PT0505	10
6	6	RPQ PT0606	10
8	8	RPQ PT0808	10
10	10	RPQ PT1010	10
12	12	RPQ PT1212	5



Y de derivaciones - RPY PT

T2

Para tubo Ø ext. (mm)	Enchufe Ø int. (mm)	Referencia	Emba.
4	4	RPY PT0404	10
5	5	RPY PT0505	10
6	6	RPY PT0606	10
8	8	RPY PT0808	10
10	10	RPY PT1010	10
12	12	RPY PT1212	5
14	14	RPY PT1414	5
16	16	RPY PT1616	5



Y igual - RPY ET

T2

Para tubo Ø ext. (mm)	Referencia	Emba.
4	RPY ET0404	10
5	RPY ET0505	10
6	RPY ET0606	10
8	RPY ET0808	10
10	RPY ET1010	10
12	RPY ET1212	5
14	RPY ET1414	5
16	RPY ET1616	5



Y de derivaciones para tubos desiguales - RPY PT

T2

Para tubo Ø ext. (x2) (mm)	Enchufe Ø int. (mm)	Referencia	Emba.
4	6	RPY PT0604	10
6	8	RPY PT0806	10
8	10	RPY PT1008	10
10	12	RPY PT1210	5



ENCHUFES INSTANTÁNEOS DE POLÍMERO

T igual - RPT ET

T2

Para tubo Ø ext. (mm)	Referencia	Emba.
4	RPT ET0404	10
5	RPT ET0505	10
6	RPT ET0606	10
8	RPT ET0808	10
10	RPT ET1010	10
12	RPT ET1212	5
14	RPT ET1414	5
16	RPT ET1616	5



ENCHUFES INSTANTÁNEOS DE POLÍMERO

Cruz igual - RPX ET

T2

Para tubo Ø ext. (mm)	Referencia	Emba.
4	RPX ET0404	10
5	RPX ET0505	10
6	RPX ET0606	10
8	RPX ET0808	10
10	RPX ET1010	10
12	RPX ET1212	5



T para tubos desiguales - Ø superior en el centro - RPT JT

T2

Para tubo Ø ext. (mm)	Para tubo Ø ext. (x2)(mm)	Referencia	Emba.
6	4	RPT JT0604	10
8	6	RPT JT0806	10
10	8	RPT JT1008	10
12	10	RPT JT1210	10
16	12	RPT JT1612	5



Unión triple para tubos - RPN ET

T2

Para tubo Ø ext. (mm)	Referencia	Emba.
4	RPN ET0404	1
5	RPN ET0505	1
6	RPN ET0606	1
8	RPN ET0808	1



T para tubos desiguales - Ø inferior en el centro - RPT IT

T2

Para tubo Ø ext. (x2)(mm)	Para tubo Ø ext. (mm)	Referencia	Emba.
6	4	RPT IT0604	10
8	6	RPT IT0806	10
10	8	RPT IT1008	10
12	10	RPT IT1210	10
16	12	RPT IT1612	5



Unión triple para tubos desiguales - RPN IT

T2

Para tubo Ø ext. (x2) (mm)	Para tubo Ø ext. (x3) (mm)	Referencia	Emba.
6	4	RPN IT0604	1
8	4	RPN IT0804	1
8	6	RPN IT0806	1
10	6	RPN IT1006	1
10	8	RPN IT1008	1



ENCHUFES INSTANTÁNEOS DE POLÍMERO

Válvula antirretorno - RPA ET

T2

Para tubo Ø ext. (mm)	Referencia	Emba.
4	RPA ET0404	1
5	RPA ET0505	1
6	RPA ET0606	1
8	RPA ET0808	1
10	RPA ET1010	1
12	RPA ET1212	1
Material : Látón niquelado		



Tapón para tubo - RPH EE

T2

Para tubo Ø ext. (mm)	Referencia	Emba.
4	RPH EE0404	10
5	RPH EE0505	10
6	RPH EE0606	10
8	RPH EE0808	10
10	RPH EE1010	10
12	RPH EE1212	10
14	RPH EE1414	10
16	RPH EE1616	10



Tapón de enchufe - RPH PT

T2

Para racor Ø int. (mm)	Referencia	Emba.
4	RPH PT0404	10
6	RPH PT0606	10
8	RPH PT0808	10
10	RPH PT1010	10
12	RPH PT1212	5



ENCHUFES INSTANTÁNEOS DE POLÍMERO

Casquillo de unión para enchufe autoblocante - RPJ PG

T2

Rosca macho BSPP	Enchufe Ø int. (mm)	Referencia	Emba.
G 1/8	4	RPJ PG0400	10
G 1/8	5	RPJ PG0500	10
G 1/4	5	RPJ PG0501	10
G 1/8	6	RPJ PG0600	10
G 1/4	6	RPJ PG0601	10
G 1/8	8	RPJ PG0800	10
G 1/4	8	RPJ PG0801	10
G 3/8	8	RPJ PG0802	10
G 1/4	10	RPJ PG1001	10
G 3/8	10	RPJ PG1002	10
G 1/4	12	RPJ PG1201	10
G 3/8	12	RPJ PG1202	5



Casquillo de unión para enchufe autoblocante - RPJ PG

T2

Rosca macho métrica	Para enchufe Ø int. (mm)	Referencia	Emba.
M5	4	RPJ PG04M5	10
M5	5	RPJ PG05M5	10
M5	6	RPJ PG06M5	10



SURTIDO DE ENCHUFES INSTANTÁNEOS CONEX

Caja de enchufes instantáneos de polímero CONEX

T2

Referencia	Emba.
MAL RP150	1
Composición : Surtido con:	
50 enchufes rectos machos cilíndricos : (para tubo Ø ext.) 10 x RPD MR0801 (Ø 8 mm) / 10 x RPD MR0601 (Ø 6 mm) 10 x RPD MR0600 (Ø 6 mm) / 10 x RPD MR0802 (Ø 8 mm) 10 x RPD MR0800 (Ø 8 mm)	
40 codos machos conicos : (para tubo Ø ext.) 10 x RPC MR0801 (Ø 8 mm) / 10 x RPC MR0600 (Ø 6 mm) 10 x RPC MR0601 (Ø 6 mm) / 10 x RPC MR0800 (Ø 8 mm)	
10 codos machos cilíndricos : (para tubo Ø ext.) 10 x RPC MG0601 (Ø 6 mm)	
30 uniones iguales para tubos : (para tubo Ø ext.) 10 x RPU ET0606 (Ø 6 mm) / 10 x RPU ET0808 (Ø 8 mm) 10 x RPU ET1010 (Ø 10 mm)	
20 T iguales para tubos : (para tubo Ø ext.) 10 x RPT ET0606 (Ø 6 mm) / 10 x RPT ET0808 (Ø 8 mm)	
1 cortatubos : R22 CT	



ENCHUFES INSTANTÁNEOS DE POLÍMERO MICRO VÁLVULAS DE DESCOMPRESIÓN

Micro válvula - Tubo/Rosca macho cilíndrico - RPS PG T2

Rosca macho BSPP	Para tubo Ø ext. (mm)	Referencia	Emba.
G 1/8	6	RPS PG0600	1
G 1/4	6	RPS PG0601	1
G 3/8	6	RPS PG0602	1
G 1/8	8	RPS PG0800	1
G 1/4	8	RPS PG0801	1
G 3/8	8	RPS PG0802	1
G 1/4	10	RPS PG1001	1
G 3/8	10	RPS PG1002	1
G 1/2	10	RPS PG1003	1
G 1/4	12	RPS PG1201	1
G 3/8	12	RPS PG1202	1
G 1/2	12	RPS PG1203	1



Micro válvula - Rosca macho cilíndrico/Tubo - RPS TG T2

Rosca macho BSPP	Para tubo Ø ext. (mm)	Referencia	Emba.
G 1/8	6	RPS TG0600	1
G 1/4	6	RPS TG0601	1
G 3/8	6	RPS TG0602	1
G 1/8	8	RPS TG0800	1
G 1/4	8	RPS TG0801	1
G 3/8	8	RPS TG0802	1
G 1/4	10	RPS TG1001	1
G 3/8	10	RPS TG1002	1
G 1/2	10	RPS TG1003	1
G 1/4	12	RPS TG1201	1
G 3/8	12	RPS TG1202	1
G 1/2	12	RPS TG1203	1



ENCHUFES INSTANTÁNEOS DE POLÍMERO MICRO VÁLVULAS DE DESCOMPRESIÓN

Micro válvula - Rosca macho cilíndrica - RPS DG T2

Rosca macho BSPP	Rosca macho BSPP	Referencia	Emba.
G 1/8	G 1/8	RPS DG0000	1
G 1/4	G 1/8	RPS DG0100	1
G 1/4	G 1/4	RPS DG0101	1
G 3/8	G 1/4	RPS DG0201	1
G 3/8	G 3/8	RPS DG0202	1
G 1/2	G 3/8	RPS DG0302	1
G 1/2	G 1/2	RPS DG0303	1



Micro válvula - Tubos iguales - RPS ET T2

Para tubo Ø ext. (mm)	Referencia	Emba.
6	RPS ET0606	1
8	RPS ET0808	1
10	RPS ET1010	1
12	RPS ET1212	1



Micro válvula - Tubos desiguales - RPS IT T2

Para tubo Ø ext. (mm)	Para tubo Ø ext. (mm)	Referencia	Emba.
8	6	RPS IT0806	1
12	10	RPS IT1210	1



ENCHUFES INSTANTÁNEOS DE POLÍMERO REGULADORES DE CAUDAL

Regulador de caudal macho cónico con moleta - admisión - RPM IR

T2

Rosca macho BSPT	Para tubo Ø ext. (mm)	Referencia	Emba.
R 1/8	4	RPM IR0400	1
R 1/4	4	RPM IR0401	1
R 1/8	6	RPM IR0600	1
R 1/4	6	RPM IR0601	1
R 3/8	6	RPM IR0602	1
R 1/2	6	RPM IR0603	1
R 1/8	8	RPM IR0800	1
R 1/4	8	RPM IR0801	1
R 3/8	8	RPM IR0802	1
R 1/2	8	RPM IR0803	1
R 1/8	10	RPM IR1000	1
R 1/4	10	RPM IR1001	1
R 3/8	10	RPM IR1002	1
R 1/2	10	RPM IR1003	1
R 1/4	12	RPM IR1201	1
R 3/8	12	RPM IR1202	1
R 1/2	12	RPM IR1203	1



ENCHUFES INSTANTÁNEOS DE POLÍMERO REGULADORES DE CAUDAL

Regulador de caudal macho cónico con moleta - escape - RPM OR

T2

Rosca macho BSPT	Para tubo Ø ext. (mm)	Referencia	Emba.
R 1/8	4	RPM OR0400	1
R 1/4	4	RPM OR0401	1
R 1/8	6	RPM OR0600	1
R 1/4	6	RPM OR0601	1
R 3/8	6	RPM OR0602	1
R 1/2	6	RPM OR0603	1
R 1/8	8	RPM OR0800	1
R 1/4	8	RPM OR0801	1
R 3/8	8	RPM OR0802	1
R 1/2	8	RPM OR0803	1
R 1/8	10	RPM OR1000	1
R 1/4	10	RPM OR1001	1
R 3/8	10	RPM OR1002	1
R 1/2	10	RPM OR1003	1
R 1/4	12	RPM OR1201	1
R 3/8	12	RPM OR1202	1
R 1/2	12	RPM OR1203	1



Regulador de caudal macho cilíndrico con moleta - admisión - RPM IG

T2

Rosca macho BSPP	Para tubo Ø ext. (mm)	Referencia	Emba.
G 1/8	4	RPM IG0400	1
G 1/4	4	RPM IG0401	1
G 1/8	6	RPM IG0600	1
G 1/4	6	RPM IG0601	1
G 3/8	6	RPM IG0602	1
G 1/2	6	RPM IG0603	1
G 1/8	8	RPM IG0800	1
G 1/4	8	RPM IG0801	1
G 3/8	8	RPM IG0802	1
G 1/2	8	RPM IG0803	1
G 1/8	10	RPM IG1000	1
G 1/4	10	RPM IG1001	1
G 3/8	10	RPM IG1002	1
G 1/2	10	RPM IG1003	1
G 1/4	12	RPM IG1201	1
G 3/8	12	RPM IG1202	1
G 1/2	12	RPM IG1203	1



Regulador de caudal macho cilíndrico con moleta - escape - RPM OG

T2

Rosca macho BSPP	Para tubo Ø ext. (mm)	Referencia	Emba.
G 1/8	4	RPM OG0400	1
G 1/4	4	RPM OG0401	1
G 1/8	6	RPM OG0600	1
G 1/4	6	RPM OG0601	1
G 3/8	6	RPM OG0602	1
G 1/2	6	RPM OG0603	1
G 1/8	8	RPM OG0800	1
G 1/4	8	RPM OG0801	1
G 3/8	8	RPM OG0802	1
G 1/2	8	RPM OG0803	1
G 1/8	10	RPM OG1000	1
G 1/4	10	RPM OG1001	1
G 3/8	10	RPM OG1002	1
G 1/2	10	RPM OG1003	1
G 1/4	12	RPM OG1201	1
G 3/8	12	RPM OG1202	1
G 1/2	12	RPM OG1203	1



Regulador de caudal macho cilíndrico con moleta - admisión - RPM IG

T2

Rosca macho métrica	Para tubo Ø ext. (mm)	Referencia	Emba.
M5	4	RPM IG04M5	1
M5	6	RPM IG06M5	1



Regulador de caudal macho cilíndrico con moleta - escape - RPM OG

T2

Rosca macho métrica	Para tubo Ø ext. (mm)	Referencia	Emba.
M5	4	RPM OG04M5	1
M5	6	RPM OG06M5	1



ENCHUFES INSTANTÁNEOS DE POLÍMERO REGULADORES DE CAUDAL

Regulador de caudal macho cónico con moleta bidirec. - RPM BR

T2



Rosca macho BSPT	Para tubo Ø ext. (mm)	Referencia	Emba.
R 1/8	4	RPM BR0400	1
R 1/4	4	RPM BR0401	1
R 1/8	6	RPM BR0600	1
R 1/4	6	RPM BR0601	1
R 3/8	6	RPM BR0602	1
R 1/2	6	RPM BR0603	1
R 1/8	8	RPM BR0800	1
R 1/4	8	RPM BR0801	1
R 3/8	8	RPM BR0802	1
R 1/2	8	RPM BR0803	1
R 1/8	10	RPM BR1000	1
R 1/4	10	RPM BR1001	1
R 3/8	10	RPM BR1002	1
R 1/2	10	RPM BR1003	1
R 1/4	12	RPM BR1201	1
R 3/8	12	RPM BR1202	1
R 1/2	12	RPM BR1203	1

Regulador de caudal macho cilíndrico con moleta bidirec. - RPM BG

T2



Rosca macho BSPP	Para tubo Ø ext. (mm)	Referencia	Emba.
G 1/8	4	RPM BG0400	1
G 1/4	4	RPM BG0401	1
G 1/8	6	RPM BG0600	1
G 1/4	6	RPM BG0601	1
G 3/8	6	RPM BG0602	1
G 1/2	6	RPM BG0603	1
G 1/8	8	RPM BG0800	1
G 1/4	8	RPM BG0801	1
G 3/8	8	RPM BG0802	1
G 1/2	8	RPM BG0803	1
G 1/8	10	RPM BG1000	1
G 1/4	10	RPM BG1001	1
G 3/8	10	RPM BG1002	1
G 1/2	10	RPM BG1003	1
G 1/4	12	RPM BG1201	1
G 3/8	12	RPM BG1202	1
G 1/2	12	RPM BG1203	1

Regulador de caudal macho cónico con moleta bidirec. - RPM BG

T2



Rosca macho métrica	Para tubo Ø ext. (mm)	Referencia	Emba.
M5	4	RPM BG04M5	1
M5	6	RPM BG06M5	1

ENCHUFES INSTANTÁNEOS DE POLÍMERO REGULADORES DE CAUDAL

Regulador de caudal macho cónico con tuerca - admisión - RPV IR

T2



Rosca macho BSPT	Para tubo Ø ext. (mm)	Referencia	Emba.
R 1/8	4	RPV IR0400	1
R 1/4	4	RPV IR0401	1
R 1/8	6	RPV IR0600	1
R 1/4	6	RPV IR0601	1
R 3/8	6	RPV IR0602	1
R 1/2	6	RPV IR0603	1
R 1/8	8	RPV IR0800	1
R 1/4	8	RPV IR0801	1
R 3/8	8	RPV IR0802	1
R 1/2	8	RPV IR0803	1
R 1/8	10	RPV IR1000	1
R 1/4	10	RPV IR1001	1
R 3/8	10	RPV IR1002	1
R 1/2	10	RPV IR1003	1
R 1/4	12	RPV IR1201	1
R 3/8	12	RPV IR1202	1
R 1/2	12	RPV IR1203	1

Regulador de caudal macho cilíndrico con tuerca - admisión - RPV IG

T2



Rosca macho BSPP	Para tubo Ø ext. (mm)	Referencia	Emba.
G 1/8	4	RPV IG0400	1
G 1/4	4	RPV IG0401	1
G 1/8	6	RPV IG0600	1
G 1/4	6	RPV IG0601	1
G 3/8	6	RPV IG0602	1
G 1/2	6	RPV IG0603	1
G 1/8	8	RPV IG0800	1
G 1/4	8	RPV IG0801	1
G 3/8	8	RPV IG0802	1
G 1/2	8	RPV IG0803	1
G 1/8	10	RPV IG1000	1
G 1/4	10	RPV IG1001	1
G 3/8	10	RPV IG1002	1
G 1/2	10	RPV IG1003	1
G 1/4	12	RPV IG1201	1
G 3/8	12	RPV IG1202	1
G 1/2	12	RPV IG1203	1

Regulador de caudal macho cilíndrico con tuerca - admisión - RPV IG

T2



Rosca macho métrica	Para tubo Ø ext. (mm)	Referencia	Emba.
M5	4	RPV IG04M5	1
M5	6	RPV IG06M5	1

ENCHUFES INSTANTÁNEOS DE POLÍMERO REGULADORES DE CAUDAL

Regulador de caudal macho cónico con tuerca - escape - RPV OR

T2

Rosca macho BSPT	Para tubo Ø ext. (mm)	Referencia	Emba.
R 1/8	4	RPV OR0400	1
R 1/4	4	RPV OR0401	1
R 1/8	6	RPV OR0600	1
R 1/4	6	RPV OR0601	1
R 3/8	6	RPV OR0602	1
R 1/2	6	RPV OR0603	1
R 1/8	8	RPV OR0800	1
R 1/4	8	RPV OR0801	1
R 3/8	8	RPV OR0802	1
R 1/2	8	RPV OR0803	1
R 1/8	10	RPV OR1000	1
R 1/4	10	RPV OR1001	1
R 3/8	10	RPV OR1002	1
R 1/2	10	RPV OR1003	1
R 1/4	12	RPV OR1201	1
R 3/8	12	RPV OR1202	1
R 1/2	12	RPV OR1203	1



ENCHUFES INSTANTÁNEOS DE POLÍMERO REGULADORES DE CAUDAL

Regulador de caudal macho cónico bidireccional con tuerca - RPV BR

T2

Rosca macho BSPT	Para tubo Ø ext. (mm)	Referencia	Emba.
R 1/8	4	RPV BR0400	1
R 1/4	4	RPV BR0401	1
R 1/8	6	RPV BR0600	1
R 1/4	6	RPV BR0601	1
R 3/8	6	RPV BR0602	1
R 1/2	6	RPV BR0603	1
R 1/8	8	RPV BR0800	1
R 1/4	8	RPV BR0801	1
R 3/8	8	RPV BR0802	1
R 1/2	8	RPV BR0803	1
R 1/8	10	RPV BR1000	1
R 1/4	10	RPV BR1001	1
R 3/8	10	RPV BR1002	1
R 1/2	10	RPV BR1003	1
R 1/4	12	RPV BR1201	1
R 3/8	12	RPV BR1202	1
R 1/2	12	RPV BR1203	1



Regulador de caudal macho cilíndrico con tuerca - escape - RPV OG

T2

Rosca macho BSPP	Para tubo Ø ext. (mm)	Referencia	Emba.
G 1/8	4	RPV OG0400	1
G 1/4	4	RPV OG0401	1
G 1/8	6	RPV OG0600	1
G 1/4	6	RPV OG0601	1
G 3/8	6	RPV OG0602	1
G 1/2	6	RPV OG0603	1
G 1/8	8	RPV OG0800	1
G 1/4	8	RPV OG0801	1
G 3/8	8	RPV OG0802	1
G 1/2	8	RPV OG0803	1
G 1/8	10	RPV OG1000	1
G 1/4	10	RPV OG1001	1
G 3/8	10	RPV OG1002	1
G 1/2	10	RPV OG1003	1
G 1/4	12	RPV OG1201	1
G 3/8	12	RPV OG1202	1
G 1/2	12	RPV OG1203	1



Regulador de caudal macho cilíndrico bidireccional con tuerca - RPV BG

T2

Rosca macho BSPP	Para tubo Ø ext. (mm)	Referencia	Emba.
G 1/8	4	RPV BG0400	1
G 1/4	4	RPV BG0401	1
G 1/8	6	RPV BG0600	1
G 1/4	6	RPV BG0601	1
G 3/8	6	RPV BG0602	1
G 1/2	6	RPV BG0603	1
G 1/8	8	RPV BG0800	1
G 1/4	8	RPV BG0801	1
G 3/8	8	RPV BG0802	1
G 1/2	8	RPV BG0803	1
G 1/8	10	RPV BG1000	1
G 1/4	10	RPV BG1001	1
G 3/8	10	RPV BG1002	1
G 1/2	10	RPV BG1003	1
G 1/4	12	RPV BG1201	1
G 3/8	12	RPV BG1202	1
G 1/2	12	RPV BG1203	1



Regulador de caudal macho cilíndrico con tuerca - escape - RPV OG

T2

Rosca macho métrica	Para tubo Ø ext. (mm)	Referencia	Emba.
M5	4	RPV OG04M5	1
M5	6	RPV OG06M5	1



Regulador de caudal macho cilíndrico bidireccional con tuerca - RPV BG

T2

Rosca macho métrica	Para tubo Ø ext. (mm)	Referencia	Emba.
M5	4	RPV BG04M5	1
M5	6	RPV BG06M5	1



ENCHUFES INSTANTÁNEOS DE POLÍMERO REGULADORES DE CAUDAL

Regulador de caudal unidireccional - Tubo/Rosca macho cilíndrico - RPL PG

T2

Rosca macho BSPP	Para tubo Ø ext. (mm)	Referencia	Emba.
G 1/8	4	RPL PG0400	1
G 1/8	6	RPL PG0600	1
G 1/4	6	RPL PG0601	1
G 1/8	8	RPL PG0800	1
G 1/4	8	RPL PG0801	1
G 3/8	8	RPL PG0802	1
G 1/4	10	RPL PG1001	1
G 3/8	10	RPL PG1002	1
G 1/2	10	RPL PG1003	1
G 1/4	12	RPL PG1201	1
G 3/8	12	RPL PG1202	1
G 1/2	12	RPL PG1203	1



Regulador de caudal unidireccional - Rosca macho cilíndrico/Tubo - RPL TG

T2

Rosca macho BSPP	Para tubo Ø ext. (mm)	Referencia	Emba.
G 1/8	4	RPL TG0400	1
G 1/8	6	RPL TG0600	1
G 1/4	6	RPL TG0601	1
G 1/8	8	RPL TG0800	1
G 1/4	8	RPL TG0801	1
G 3/8	8	RPL TG0802	1
G 1/4	10	RPL TG1001	1
G 3/8	10	RPL TG1002	1
G 1/2	10	RPL TG1003	1
G 1/4	12	RPL TG1201	1
G 3/8	12	RPL TG1202	1
G 1/2	12	RPL TG1203	1



ENCHUFES INSTANTÁNEOS DE POLÍMERO REGULADORES DE CAUDAL

Regulador de caudal unidireccional - Rosca macho cilíndrico/Rosca macho cilíndrico - RPL DG

T2

Rosca macho BSPP	Rosca macho BSPP	Referencia	Emba.
G 1/8	G 1/8	RPL DG0000	1
G 1/4	G 1/4	RPL DG0101	1
G 3/8	G 3/8	RPL DG0202	1
G 1/2	G 1/2	RPL DG0303	1



Regulador de caudal unidireccional - Tubo/Tubo - RPL ET

T2

Para tubo Ø ext. (mm)	Referencia	Emba.
4	RPL ET0404	1
6	RPL ET0606	1
8	RPL ET0808	1
10	RPL ET1010	1
12	RPL ET1212	1



Regulador de caudal bidireccional - Tubo/Tubo - RPO ET

T2

Para tubo Ø ext. (mm)	Referencia	Emba.
4	RPO ET0404	1
6	RPO ET0606	1
8	RPO ET0808	1
10	RPO ET1010	1
12	RPO ET1212	1



ENCHUFES INSTANTÁNEOS DE POLÍMERO MICRO CONEX

Micro enchufe recto macho cilíndrico - RCD MG

T2

Rosca macho BSPP	Para tubo Ø ext. (mm)	Referencia	Emba.
G 1/8	4	RCD MG0400	10
G 1/8	6	RCD MG0600	10
Material : Láton niquelado			



ENCHUFES INSTANTÁNEOS DE POLÍMERO MICRO CONEX

Micro codo 90° macho cilíndrico - RCC MG

T2

Rosca macho BSPP	Para tubo Ø ext. (mm)	Referencia	Emba.
G 1/8	4	RCC MG0400	10
G 1/8	6	RCC MG0600	10



Micro enchufe recto macho cilíndrico - RCD MG

T2

Rosca macho métrica	Para tubo Ø ext. (mm)	Referencia	Emba.
M3	3	RCD MG03M3	10
M5	3	RCD MG03M5	10
M3	4	RCD MG04M3	10
M5	4	RCD MG04M5	10
M5	6	RCD MG06M5	10
Material : Láton niquelado			



Micro codo 90° macho cilíndrico - RCC MG

T2

Rosca macho métrica	Para tubo Ø ext. (mm)	Referencia	Emba.
M3	3	RCC MG03M3	10
M5	3	RCC MG03M5	10
M3	4	RCC MG04M3	10
M5	4	RCC MG04M5	10
M5	6	RCC MG06M5	10



Micro enchufe recto hembra cilíndrica - RCD FG

T2

Rosca hembra BSPP	Para tubo Ø ext. (mm)	Referencia	Emba.
G 1/8	4	RCD FG0400	10
G 1/8	6	RCD FG0600	10
Material : Láton niquelado			



Micro codo 90° macho cilíndrico largo - RCC LG

T2

Rosca macho BSPP	Para tubo Ø ext. (mm)	Referencia	Emba.
G 1/8	4	RCC LG0400	10
G 1/8	6	RCC LG0600	10



Micro enchufe recto hembra cilíndrica - RCD FG

T2

Rosca hembra métrica	Para tubo Ø ext. (mm)	Referencia	Emba.
M3	3	RCD FG03M3	10
M5	3	RCD FG03M5	10
M3	4	RCD FG04M3	10
M5	4	RCD FG04M5	10
M5	6	RCD FG06M5	10
Material : Láton niquelado			



Micro codo 90° macho cilíndrico largo - RCC LG

T2

Rosca macho métrica	Para tubo Ø ext. (mm)	Referencia	Emba.
M3	3	RCC LG03M3	10
M5	3	RCC LG03M5	10
M3	4	RCC LG04M3	10
M5	4	RCC LG04M5	10
M5	6	RCC LG06M5	10



ENCHUFES INSTANTÁNEOS DE POLÍMERO MICRO CONEX

Micro T macho cilíndrico en el centro - RCT CG

T2

Rosca macho BSPP	Para tubo Ø ext. (mm)	Referencia	Emba.
G 1/8	4	RCT CG0400	10
G 1/8	6	RCT CG0600	10



ENCHUFES INSTANTÁNEOS DE POLÍMERO MICRO CONEX

Micro unión igual para tubo - RCU ET

T2

Para tubo Ø ext. (mm)	Referencia	Emba.
3	RCU ET0303	10
4	RCU ET0404	10
6	RCU ET0606	10



Micro T macho cilíndrico en el centro - RCT CG

T2

Rosca macho métrica	Para tubo Ø ext. (mm)	Referencia	Emba.
M3	3	RCT CG03M3	10
M5	3	RCT CG03M5	10
M3	4	RCT CG04M3	10
M5	4	RCT CG04M5	10
M5	6	RCT CG06M5	10



Micro unión para pasatabiques - RCU TT

T2

Para tubo Ø ext. (mm)	Referencia	Emba.
3	RCU TT0303	10
4	RCU TT0404	10
6	RCU TT0606	10

Material : Latón niquelado



Micro T macho cilíndrico lateral - RCT AG

T2

Rosca macho BSPP	Para tubo Ø ext. (mm)	Referencia	Emba.
G 1/8	4	RCT AG0400	10
G 1/8	6	RCT AG0600	10



Micro codo igual 90° - RCC ET

T2

Para tubo Ø ext. (mm)	Referencia	Emba.
3	RCC ET0303	10
4	RCC ET0404	10
6	RCC ET0606	10



Micro T macho cilíndrico lateral - RCT AG

T2

Rosca macho métrica	Para tubo Ø ext. (mm)	Referencia	Emba.
M3	3	RCT AG03M3	10
M5	3	RCT AG03M5	10
M3	4	RCT AG04M3	10
M5	4	RCT AG04M5	10
M5	6	RCT AG06M5	10



Micro T igual - RCT ET

T2

Para tubo Ø ext. (mm)	Referencia	Emba.
3	RCT ET0303	10
4	RCT ET0404	10
6	RCT ET0606	10



ENCHUFES INSTANTÁNEOS DE POLÍMERO MICRO CONEX

Micro Y igual - RCY ET

T2

Para tubo Ø ext. (mm)	Referencia	Emba.
4	RCY ET0404	10
6	RCY ET0606	10

Micro regulador de caudal macho cilíndrico con moleta - admisión - RCM IG

T2

Rosca macho métrica	Para tubo Ø ext. (mm)	Referencia	Emba.
M5	3	RCM IG03M5	1
M5	4	RCM IG04M5	1

Micro regulador de caudal macho cilíndrico con moleta - escape - RCM OG

T2

Rosca macho métrica	Para tubo Ø ext. (mm)	Referencia	Emba.
M5	3	RCM OG03M5	1
M5	4	RCM OG04M5	1

Micro regulador de caudal macho cilíndrico con moleta bidireccional - RCM BG

T2

Rosca macho métrica	Para tubo Ø ext. (mm)	Referencia	Emba.
M5	3	RCM BG03M5	1
M5	4	RCM BG04M5	1

PRODUCTOS ASOCIADOS



Tubos de poliamida y poliuretano - p 114



Corta tubos - p 70

ENCHUFES INSTANTÁNEOS DE METAL

Enchufe recto macho cónico - RMD MR

T2

Rosca macho BSPT	Para tubo Ø ext. (mm)	Referencia	Emba.
R 1/8	4	RMD MR0400	10
R 1/8	6	RMD MR0600	10
R 1/4	6	RMD MR0601	10
R 1/8	8	RMD MR0800	10
R 1/4	8	RMD MR0801	10
R 3/8	8	RMD MR0802	10
R 1/4	10	RMD MR1001	10
R 3/8	10	RMD MR1002	10
R 3/8	12	RMD MR1202	5
R 1/2	12	RMD MR1203	5

Enchufe recto macho cilíndrico - RMD MG

T2

Rosca macho BSPP	Para tubo Ø ext. (mm)	Referencia	Emba.
G 1/8	4	RMD MG0400	10
G 1/4	4	RMD MG0401	10
G 1/8	6	RMD MG0600	10
G 1/4	6	RMD MG0601	10
G 1/8	8	RMD MG0800	10
G 1/4	8	RMD MG0801	10
G 3/8	8	RMD MG0802	10
G 1/4	10	RMD MG1001	10
G 3/8	10	RMD MG1002	10
G 1/2	10	RMD MG1003	10
G 1/4	12	RMD MG1201	5
G 3/8	12	RMD MG1202	5
G 1/2	12	RMD MG1203	5
G 3/8	14	RMD MG1402	5
G 1/2	14	RMD MG1403	5

Enchufe recto hembra cilíndrica - RMD FG

T2

Rosca hembra BSPP	Para tubo Ø ext. (mm)	Referencia	Emba.
G 1/8	4	RMD FG0400	10
G 1/8	6	RMD FG0600	10
G 1/4	6	RMD FG0601	10
G 1/8	8	RMD FG0800	10
G 1/4	8	RMD FG0801	10
G 1/4	10	RMD FG1001	10

ENCHUFES INSTANTÁNEOS DE METAL

Codo 90° macho cónico orientable - RMC MR

T2

Rosca macho BSPT	Para tubo Ø ext. (mm)	Referencia	Emba.
R 1/8	4	RMC MR0400	10
R 1/4	4	RMC MR0401	10
R 1/8	6	RMC MR0600	10
R 1/4	6	RMC MR0601	10
R 1/8	8	RMC MR0800	10
R 1/4	8	RMC MR0801	10
R 3/8	8	RMC MR0802	10
R 1/4	10	RMC MR1001	10
R 3/8	10	RMC MR1002	10
R 3/8	12	RMC MR1202	5
R 1/2	12	RMC MR1203	5
R 1/2	14	RMC MR1403	5



Codo 90° macho cilíndrico orientable - RMC MG

T2

Rosca macho BSPP	Para tubo Ø ext. (mm)	Referencia	Emba.
G 1/8	4	RMC MG0400	10
G 1/4	4	RMC MG0401	10
G 1/8	6	RMC MG0600	10
G 1/4	6	RMC MG0601	10
G 1/8	8	RMC MG0800	10
G 1/4	8	RMC MG0801	10
G 3/8	8	RMC MG0802	10
G 1/4	10	RMC MG1001	10
G 3/8	10	RMC MG1002	10
G 1/2	10	RMC MG1003	10
G 1/4	12	RMC MG1201	5
G 3/8	12	RMC MG1202	5
G 1/2	12	RMC MG1203	5
G 1/2	14	RMC MG1403	5



Codo 90° macho cónico fijo - RMC XR

T2

Rosca macho BSPT	Para tubo Ø ext. (mm)	Referencia	Emba.
R 1/8	4	RMC XR0400	10
R 1/8	6	RMC XR0600	10
R 1/4	6	RMC XR0601	10
R 1/8	8	RMC XR0800	10
R 1/4	8	RMC XR0801	10
R 1/4	10	RMC XR1001	10



ENCHUFES INSTANTÁNEOS DE METAL

T macho cónico en el centro orientable - RMT CR

T2

Rosca macho BSPT	Para tubo Ø ext. (mm)	Referencia	Emba.
R 1/8	4	RMT CR0400	10
R 1/4	4	RMT CR0401	10
R 1/8	6	RMT CR0600	10
R 1/4	6	RMT CR0601	10
R 1/8	8	RMT CR0800	10
R 1/4	8	RMT CR0801	10
R 3/8	8	RMT CR0802	10
R 1/4	10	RMT CR1001	10
R 3/8	10	RMT CR1002	10



T macho cilíndrico en el centro orientable - RMT CG

T2

Rosca macho BSPP	Para tubo Ø ext. (mm)	Referencia	Emba.
G 1/8	4	RMT CG0400	10
G 1/4	4	RMT CG0401	10
G 1/8	6	RMT CG0600	10
G 1/4	6	RMT CG0601	10
G 1/8	8	RMT CG0800	10
G 1/4	8	RMT CG0801	10
G 3/8	8	RMT CG0802	10
G 1/4	10	RMT CG1001	10
G 3/8	10	RMT CG1002	10
G 3/8	12	RMT CG1202	1
G 1/2	12	RMT CG1203	1
G 1/2	14	RMT CG1403	1



T macho cónico lateral orientable - RMT AR

T2

Rosca macho BSPT	Para tubo Ø ext. (mm)	Referencia	Emba.
R 1/8	4	RMT AR0400	10
R 1/8	6	RMT AR0600	10
R 1/4	6	RMT AR0601	10
R 1/8	8	RMT AR0800	10
R 1/4	8	RMT AR0801	10
R 1/4	10	RMT AR1001	10
R 3/8	10	RMT AR1002	10
R 3/8	12	RMT AR1202	1
R 1/2	12	RMT AR1203	1



ENCHUFES INSTANTÁNEOS DE METAL

T macho cilíndrico lateral orientable - RMT AG

T2

Rosca macho BSPP	Para tubo Ø ext. (mm)	Referencia	Emba.
G 1/8	4	RMT AG0400	10
G 1/8	6	RMT AG0600	10
G 1/4	6	RMT AG0601	10
G 1/8	8	RMT AG0800	10
G 1/4	8	RMT AG0801	10
G 1/4	10	RMT AG1001	10
G 3/8	10	RMT AG1002	10
G 3/8	12	RMT AG1202	1
G 1/2	12	RMT AG1203	1

ENCHUFES INSTANTÁNEOS DE METAL

Codo igual 90° - RMC ET

T2

Para tubo Ø ext. (mm)	Referencia	Emba.
4	RMC ET0404	10
6	RMC ET0606	10
8	RMC ET0808	10
10	RMC ET1010	10
12	RMC ET1212	5
14	RMC ET1414	5

Unión igual para tubo - RMU ET

T2

Para tubo Ø ext. (mm)	Referencia	Emba.
4	RMU ET0404	10
6	RMU ET0606	10
8	RMU ET0808	10
10	RMU ET1010	10
12	RMU ET1212	5
14	RMU ET1414	5

T igual - RMT ET

T2

Para tubo Ø ext. (mm)	Referencia	Emba.
4	RMT ET0404	10
6	RMT ET0606	10
8	RMT ET0808	10
10	RMT ET1010	10
12	RMT ET1212	1
14	RMT ET1414	1

Unión para pasatabiques - RMU TT

T2

Para tubo Ø ext. (mm)	Referencia	Emba.
4	RMU TT0404	10
6	RMU TT0606	10
8	RMU TT0808	10
10	RMU TT1010	10
12	RMU TT1212	1

Micro válvula - Tubos iguales - RMF ET

T2

Para tubo Ø ext. (mm)	Referencia	Emba.
4	RMF ET0404	1
6	RMF ET0606	1
8	RMF ET0808	1

ENCHUFES INSTANTÁNEOS DE INOX AISI 316

Enchufe recto macho cónico - RX1

T6

Rosca macho BSPT	Para tubo Ø ext. (mm)	Referencia	Emba.
R 1/8	4	RX1 418	1
R 1/8	6	RX1 618	1
R 1/4	6	RX1 614	1
R 1/8	8	RX1 818	1
R 1/4	8	RX1 814	1
R 3/8	8	RX1 838	1



ENCHUFES INSTANTÁNEOS DE INOX AISI 316

T igual - RX9

T6

Para tubo Ø ext. (mm)	Referencia	Emba.
4	RX9 4	1
6	RX9 6	1
8	RX9 8	1



Codo macho 90° cilíndrico orientable - RX5

T6

Rosca macho BSPP	Para tubo Ø ext. (mm)	Referencia	Emba.
G 1/8	4	RX5 418	1
G 1/8	6	RX5 618	1
G 1/4	6	RX5 614	1
G 1/8	8	RX5 818	1
G 1/4	8	RX5 814	1
G 3/8	8	RX5 838	1



ENCHUFES INSTANTÁNEOS - ACCESORIOS

Codo igual 90° - RX6

T6

Para tubo Ø ext. (mm)	Referencia	Emba.
4	RX6 4	1
6	RX6 6	1
8	RX6 8	1



Cortatubos - R22 CT

T2

Dénominación	Referencia	Emba.
Cortatubos	R22 CT	1
Diseñado especialmente para obtener cortes perfectos a 90°		



Herramienta de desconexión - R22

T2

Dénominación	Referencia	Emba.
Herramienta de desconexión	R22 TD	1



T macho en el centro cilíndrico orientable - RX7

T6

Rosca macho BSPP	Para tubo Ø ext. (mm)	Referencia	Emba.
G 1/8	4	RX7 418	1
G 1/8	6	RX7 618	1
G 1/4	6	RX7 614	1
G 1/8	8	RX7 818	1
G 1/4	8	RX7 814	1
G 3/8	8	RX7 838	1



PRODUCTOS ASOCIADOS



Tubos de poliamida y poliuretano
- p 114

ENCHUFES DE COMPRESIÓN

Enchufe recto rosca macho cónico - RB1

T2

Rosca macho BSPT	Para tubo Ø (mm)	Referencia	Emba.
R 1/8	6 x 4	RB1 618	10
R 1/4	6 x 4	RB1 614	10
R 1/8	8 x 6	RB1 818	10
R 1/4	8 x 6	RB1 814	10
R 3/8	8 x 6	RB1 838	10
R 1/4	10 x 8	RB1 1014	10
R 3/8	10 x 8	RB1 1038	10
R 3/8	12 x 10	RB1 1238	10

Unión igual - RB3

T2

Para tubo Ø (mm)	Referencia	Emba.
6 x 4	RB3 6	10
8 x 6	RB3 8	10
10 x 8	RB3 10	10
12 x 10	RB3 12	10

Codo macho 90° cónico - RB5

T2

Rosca macho BSPT	Para tubo Ø (mm)	Referencia	Emba.
R 1/8	6 x 4	RB5 618	10
R 1/4	6 x 4	RB5 614	10
R 1/8	8 x 6	RB5 818	10
R 1/4	8 x 6	RB5 814	10
R 3/8	8 x 6	RB5 838	10
R 1/4	10 x 8	RB5 1014	10
R 3/8	10 x 8	RB5 1038	10
R 3/8	12 x 10	RB5 1238	10

Codo igual - RB6

T2

Para tubo Ø (mm)	Referencia	Emba.
6 x 4	RB6 6	10
8 x 6	RB6 8	10
10 x 8	RB6 10	10

ENCHUFES DE COMPRESIÓN

T macho en el centro cónico - RB7

T2

Rosca macho BSPT	Para tubo Ø (mm)	Referencia	Emba.
R 1/8	6 x 4	RB7 618	10
R 1/4	6 x 4	RB7 614	10
R 1/4	8 x 6	RB7 814	10
R 1/4	10 x 8	RB7 1014	10
R 3/8	10 x 8	RB7 1038	10

T igual - RB9

T2

Para tubo Ø (mm)	Referencia	Emba.
6 x 4	RB9 6	10
8 x 6	RB9 8	10
10 x 8	RB9 10	10
12 x 10	RB9 12	10

Cruz igual - RB12

T2

Para tubo Ø (mm)	Referencia	Emba.
6 x 4	RB12 6	10
8 x 6	RB12 8	10
10 x 8	RB12 10	1

ENCHUFES DE OLIVETAS

Enchufe recto macho cónico - RO1

T2

Rosca macho BSPT	Para tubo Ø ext. (mm)	Referencia	Emba.
R 1/8	4	RO1 418	10
R 1/8	6	RO1 618	10
R 1/4	6	RO1 614	10
R 1/8	8	RO1 818	10
R 1/4	8	RO1 814	10
R 3/8	8	RO1 838	10
R 1/4	10	RO1 1014	10
R 3/8	10	RO1 1038	10
R 3/8	12	RO1 1238	10
R 1/2	12	RO1 1212	10

Unión igual - RO3

T2

Para tubo Ø ext. (mm)	Referencia	Emba.
4	RO3 4	10
6	RO3 6	10
8	RO3 8	10
10	RO3 10	10
12	RO3 12	10

Codo macho 90° cónico - RO5

T2

Rosca macho BSPT	Para tubo Ø ext. (mm)	Referencia	Emba.
R 1/8	4	RO5 418	10
R 1/8	6	RO5 618	10
R 1/4	6	RO5 614	10
R 1/8	8	RO5 818	10
R 1/4	8	RO5 814	10
R 3/8	8	RO5 838	10
R 1/4	10	RO5 1014	10
R 3/8	10	RO5 1038	10
R 3/8	12	RO5 1238	10
R 1/2	12	RO5 1212	10

ENCHUFES DE OLIVETAS

Codo igual - RO6

T2

Para tubo Ø ext. (mm)	Referencia	Emba.
4	RO6 4	10
6	RO6 6	10
8	RO6 8	10
10	RO6 10	10
12	RO6 12	10

T macho en el centro - RO7

T2

Rosca macho BSPT	Para tubo Ø ext. (mm)	Referencia	Emba.
R 1/8	4	RO7 418	10
R 1/8	6	RO7 618	10
R 1/4	6	RO7 614	10
R 1/8	8	RO7 818	10
R 1/4	8	RO7 814	10

T igual - RO9

T2

Para tubo Ø ext. (mm)	Referencia	Emba.
4	RO9 4	10
6	RO9 6	10
8	RO9 8	10
10	RO9 10	10
12	RO9 12	10

Tuerca - RO E

T2

Para tubo Ø ext. (mm)	Referencia	Emba.
4	RO E4	10
6	RO E6	10
8	RO E8	10
10	RO E10	10
12	RO E12	10

Precio por 100

Oliveta - RO O

T2

Para tubo Ø ext. (mm)	Referencia	Emba.
4	RO O4	10
6	RO O6	10
8	RO O8	10
10	RO O10	10
12	RO O12	10

Precio por 100

UNIONES PARA TUBO

Unión rosca macho cónico

T2

Rosca macho BSPT	Para tubo Ø int. (mm)	Referencia	Emba.
R 1/8	4	JFT 1804	10
R 1/8	6	JFT 1806	10
R 1/8	7	JFT 1807	10
R 1/8	8	JFT 1808	10
R 1/4	4	JFT 1404	10
R 1/4	6	JFT 1406	10
R 1/4	7	JFT 1407	10
R 1/4	8	JFT 1408	10
R 1/4	9	JFT 1409	10
R 1/4	10	JFT 1410	10
R 1/4	12	JFT 1412	10
R 3/8	8	JFT 3808	10
R 3/8	9	JFT 3809	10
R 3/8	10	JFT 3810	10
R 3/8	12	JFT 3812	10
R 3/8	14	JFT 3814	10
R 3/8	16	JFT 3816	10
R 1/2	12	JFT 1212	10
R 1/2	14	JFT 1214	10
R 1/2	16	JFT 1216	1
R 1/2	19	JFT 1219	10
Material : Latón			



Unión rosca macho cilíndrico - 1 garganta

T2

Rosca macho BSPP	Para tubo Ø int. (mm)	Referencia	Emba.
G 1/8	4	JFT 1804ZS	10
G 1/8	6	JFT 1806ZS	10
G 1/4	6	JFT 1406ZS	10
G 1/4	8	JFT 1408ZS	10
G 1/4	9	JFT 1409ZS	10
G 1/4	10	JFT 1410ZS	10
G 3/8	8	JFT 3808ZS	10
G 3/8	10	JFT 3810ZS	10
G 3/8	13	JFT 3813ZS	10
G 3/8	16	JFT 3816ZS	10
G 1/2	8	JFT 1208ZS	1
G 1/2	9	JFT 1209ZS	10
G 1/2	10	JFT 1210ZS	1
G 1/2	13	JFT 1213ZS	10
G 1/2	16	JFT 1216ZS	1
G 3/4	16	JFT 3416ZS	1
Material : acero tratado			



UNIONES PARA TUBO

Unión rosca macho cilíndrico - 2 gargantas

T2

Rosca macho BSPP	Para tubo Ø int. (mm)	Referencia	Emba.
G 1/2	19	JFT 1219ZS	1
G 3/4	19	JFT 3419ZS	1
G 3/4	25	JFT 3425ZS	1
G 1	19	JFT 0119ZS	1
G 1	25	JFT 0125ZS	1
Material : acero tratado			



Unión rosca macho cónico

T2

Rosca macho BSPT	Para tubo Ø int. (mm)	Referencia	Emba.
R 1/8	6	JPC 1806	10
R 1/8	7	JPC 1807	10
R 1/8	8	JPC 1808	10
R 1/4	6	JPC 1406	10
R 1/4	7	JPC 1407	10
R 1/4	8	JPC 1408	10
R 1/4	9	JPC 1409	10
R 1/4	10	JPC 1410	10
R 3/8	9	JPC 3809	10
R 3/8	10	JPC 3810	10
R 3/8	13	JPC 3813	10
R 3/8	16	JPC 3816	10
R 3/8	19	JPC 3819	10
R 1/2	10	JPC 1210	10
R 1/2	13	JPC 1213	10
R 1/2	17	JPC 1217	10
R 1/2	19	JPC 1219	10
R 3/4	15	JPC 3415	10
R 3/4	19	JPC 3419	10
R 3/4	24	JPC 3424	10
R 1	24	JPC 0124	10
R 1/4	13	JPC 1413	10
Material : Latón niquelado			



UNIONES PARA TUBO

Unión rosca macho cilíndrico con junta

T2

Rosca macho BSPP	Para tubo Ø int. (mm)	Referencia	Emba.
G 1/8	6	JMJ 1806	10
G 1/4	6	JMJ 1406	10
G 1/4	7	JMJ 1407	10
G 1/4	8	JMJ 1408	10
G 3/8	8	JMJ 3808	10
G 1/2	10	JMJ 1210	10
G 1/2	16	JMJ 1216	10

Material : Latón niquelado



UNIONES PARA TUBO

Unión rosca macho cilíndrico para tubo autoblocante

T1

Rosca macho BSPP	Para tubo Ø int. (mm)	Color del anillo	Referencia	Emba.
G 1/4	10	amarillo	AF 15110CN	10
G 1/4	13	amarillo	AF 15113CN	10
G 1/4	13	negro	AF 15113BK	10

Montaje sin abrazaderas con tubo Lockflex
Material : Latón



Unión rosca hembra cilíndrica

T2

Rosca hembra BSPP	Para tubo Ø int. (mm)	Referencia	Emba.
G 1/8	6	JTF 1806	10
G 1/4	6	JTF 1406	10
G 1/4	7	JTF 1407	10
G 1/4	8	JTF 1408	10
G 1/4	9	JTF 1409	10
G 3/8	10	JTF 3810	10

Material : Latón



Unión rosca hembra con tuerca giratoria

T2

Rosca hembra BSPP	Para tubo Ø int. (mm)	Referencia	Emba.
G 1/4	6	JFT 1406	10
G 1/4	8	JFT 1408	10

2 piezas de estanqueidad esférica
Material : Latón niquelado



Unión rosca macho orientable

T2

Rosca macho BSPP	Para tubo Ø int. (mm)	Referencia	Emba.
G 1/4	6	JFO 1406	10
G 1/4	7	JFO 1407	10
G 1/4	8	JFO 1408	10
G 1/4	9	JFO 1409	10
G 1/4	10	JFO 1410	10

Utilización : sólo aire
Material : Acero tratado



Unión doble

T2

Para tubo Ø int. (mm)	Referencia	Emba.
4	JDT 0404	10
6	JDT 0606	10
8	JDT 0808	10
9	JDT 0909	10
10	JDT 1010	10
12	JDT 1212	10
13	JDT 1313	10
16	JDT 1616	10
19	JDT 1919	10
23	JDT 2323	1

Material : Latón



ACCESORIOS DE CONEXIÓN TETONES - REDUCCIONES

Tetón doble rosca cilíndrico - A1

T2

Rosca macho	Rosca macho	Referencia	Emba.
M5	M5	A1 M5M5	10
G 1/8	M5	A1 M518	10
G 1/8	G 1/8	A1 1818	10
G 1/4	G 1/8	A1 1814	10
G 3/8	G 1/8	A1 1838	10
G 1/4	G 1/4	A1 1414	10
G 3/8	G 1/4	A1 1438	10
G 1/2	G 1/4	A1 1412	10
1/4 NPT	G 1/4	A1 14251	10
G 3/8	G 3/8	A1 3838	10
G 1/2	G 3/8	A1 3812	10
G 3/4	G 3/8	A1 3834	10
G 1/2	G 1/2	A1 1212	10
G 1	G 1/2	A1 1201	10
G 1/2	G 3/4	A1 3412	10
G 3/4	G 3/4	A1 3434	10
G 1	G 3/4	A1 3401	10
G 1 1/4	G 3/4	A1 3442	1
G 1	G 1	A1 0101	10



ACCESORIOS DE CONEXIÓN TETONES - REDUCCIONES

Tetón doble cónico giratorio (3 piezas) - A2T

T2

Rosca macho BSPT	Rosca macho BSPT	Referencia	Emba.
R 1/8	R 1/8	A2T 1818	10
R 1/4	R 1/4	A2T 1414	10
R 3/8	R 3/8	A2T 3838	10
R 1/2	R 1/2	A2T 1212	1
R 3/4	R 3/4	A2T 3434	1
R 1	R 1	A2T 0101	1



Tetón doble rosca cónico - A2

T2

Rosca macho BSPT	Rosca macho BSPT	Referencia	Emba.
R 1/8	R 1/8	A2 1818	10
R 1/8	R 1/4	A2 1814	10
R 1/8	R 3/8	A2 1838	10
R 1/8	R 1/4	A2 1414	10
R 1/4	R 3/8	A2 1438	10
R 1/4	R 1/2	A2 1412	10
R 3/8	R 3/8	A2 3838	10
R 3/8	R 1/2	A2 3812	10
R 1/2	R 1/2	A2 1212	10
R 1/2	R 3/4	A2 1234	10
R 3/4	R 3/4	A2 3434	10
R 3/4	R 1	A2 3401	1
R 1	R 1	A2 0101	1
R 1 1/2	R 1 1/4	A2 4942	1
R 1 1/4	R 1	A2 4201	1
R 1 1/4	R 1 1/4	A2 4242	1
R 1 1/2	R 1 1/2	A2 4949	1
R 2	R 1 1/2	A2 6049	1
R 2	R 2	A2 6060	1



Manguito igual - A3

T2

Rosca hembra	Referencia	Emba.
M5 x 0,8	A3 M5	10
G 1/8	A3 18	10
G 1/4	A3 14	10
G 3/8	A3 38	10
G 1/2	A3 12	10
G 3/4	A3 34	10
G 1	A3 01	1



ACCESORIOS DE CONEXIÓN TETONES - REDUCCIONES

Reducción rosca macho cónico / hembra cilíndrico - A4 T2

Rosca macho BSPT	Rosca hembra BSPP	Referencia	Emba.
R 1/4	G 1/8	A4 1418	10
R 3/8	G 1/8	A4 3818	10
R 3/8	G 1/4	A4 3814	10
R 1/2	G 1/8	A4 1218	10
R 1/2	G 1/4	A4 1214	10
R 1/2	G 3/8	A4 1238	10
R 3/4	G 3/8	A4 3438	10
R 3/4	G 1/2	A4 3412	10
R 1	G 1/2	A4 0112	10
R 1	G 3/4	A4 0134	10
R 1 1/4	G 3/4	A4 4234	1
R 1 1/4	G 1	A4 4201	1
R 1 1/2	G 1	A4 4901	1
R 1 1/2	G 1 1/4	A4 4942	10
R 2	G 1 1/4	A4 6042	1
R 2	G 1 1/2	A4 6049	1
R 2	G 1	A4 6001	1
R 2 1/2	G 1	A4 7601	1



Reducción macho / hembra cilíndrico - A4Z T2

Rosca macho BSPP	Rosca hembra	Referencia	Emba.
G 1/8	M5	A4 18M5	10
G 1/4	G 1/8	A4Z 1418	10
G 3/8	G 1/8	A4Z 3818	10
G 3/8	G 1/4	A4Z 3814	10
G 1/2	G 1/8	A4Z 1218	10
G 1/2	G 1/4	A4Z 1214	10
G 1/2	G 3/8	A4Z 1238	10
G 3/4	G 1/4	A4Z 3414	10
G 3/4	G 3/8	A4Z 3438	10
G 3/4	G 1/2	A4Z 3412	10
G 2	G 1 1/4	A4Z 6042	1
G 2	G 1 1/2	A4Z 6049	1
G 2 1/2	G 2	A4Z 7660	1



ACCESORIOS DE CONEXIÓN PROLONGADORES

Prolongador rosca macho / hembra - A5 T2

Rosca macho	Rosca hembra BSPP	Referencia	Emba.
R 1/8	G 1/8	A5 1818	10
R 1/8	G 1/4	A5 1814	10
R 1/8	G 3/8	A5 1838	10
R 1/4	G 1/4	A5 1414	10
R 1/4	G 3/8	A5 1438	10
R 1/4	G 1/2	A5 1412	10
R 3/8	G 3/8	A5 3838	10
R 3/8	G 1/2	A5 3812	10
G 3/8	G 3/4	A5 3834	10
R 1/2	G 1/2	A5 1212	10
R 1/2	G 3/4	A5 1234	10
R 1/2	G 1	A5 1201	1
R 3/4	G 3/4	A5 3434	10
R 3/4	G 1	A5 3401	1
R 3/4	G 1 1/4	A5 3442	1
R 1	G 1 1/4	A5 0142	1
R 1 1/4	G 1 1/2	A5 4249	1



Prolongador rosca macho / hembra cilíndrico T2

Rosca macho	Rosca hembra BSPP	Referencia	Emba.
M5	G 1/8	A5 M518	10
G 1/8	G 1/8	A5Z 1818	10
G 1/8	G 1/4	A5Z 1814	10
G 1/4	G 1/4	A5Z 1414	10
G 1/4	G 3/8	A5Z 1438	10
G 1/4	G 1/2	A5Z 1412	10
G 3/8	G 3/8	A5Z 3838	10
G 3/8	G 1/2	A5Z 3812	10
G 3/8	G 3/4	A5Z 3834	10
G 1/2	G 1/2	A5Z 1212	10



Unión 3 piezas macho / hembra cilíndrico - A5T T2

Rosca macho BSPP	Rosca hembra BSPP	Referencia	Emba.
G 3/8	G 3/8	A5T 3838	10
G 1/2	G 1/2	A5T 1212	10
G 3/4	G 3/4	A5T 3434	10
G 1	G 1	A5T 0101	1
G 1 1/4	G 1 1/4	A5T 4242	1



Enchufe macho giratorio / hembra cilíndrico (una pieza) - A35 T2

Rosca macho BSPP	Rosca hembra BSPP	Referencia	Emba.
G 1/2	G 1/2	A35 1212	20,75 1
G 1/2	G 3/4	A35 1234	37,55 1



ACCESORIOS DE CONEXIÓN PROLONGADORES, TAPÓNES

Prolongador macho / hembra cilíndrico - A5 RL

T2

Rosca macho BSPP	Rosca hembra BSPP	Referencia	Emba.
G 1/8	G 1/8	A5 1818RL	10
G 1/4	G 1/4	A5 1414RL	10
G 3/8	G 3/8	A5 3838RL	10
G 1/2	G 1/2	A5 1212RL	10



ACCESORIOS DE CONEXIÓN PROLONGADORES, TAPÓNES

Tapón hexagonal rosca macho con junta - A7 J

T2

Rosca macho	Fijación	Referencia	Emba.
M5	Llave BTR de 2,5	A7 M5J	10
G 1/8	Llave BTR de 5	A7 18J	10
G 1/4	Llave BTR de 6	A7 14J	10
G 3/8	Llave BTR de 8	A7 38J	10
G 1/2	Llave BTR de 10	A7 12J	10



Prolongador hembra / hembra - A6

T2

Rosca hembra	Rosca hembra BSPP	Referencia	Emba.
M5	G 1/8	A6 M518	10
G 1/8	G 1/4	A6 1814	10
G 1/8	G 3/8	A6 1838	10
G 1/4	G 3/8	A6 1438	10
G 1/4	G 1/2	A6 1412	10
G 3/8	G 1/2	A6 3812	10



Tapón hexagonal rosca macho cónico - A18

T2

Rosca macho BSPT	Referencia	Emba.
R 1/8	A18 18	10
R 1/4	A18 14	10
R 3/8	A18 38	10
R 1/2	A18 12	10
R 3/4	A18 34	10



Tapón hexagonal rosca macho - A7

T2

Rosca macho BSPP	Referencia	Emba.
M5 x 0,8	A7 M5	10
G 1/8	A7 18	10
G 1/4	A7 14	10
G 3/8	A7 38	10
G 1/2	A7 12	10
G 3/4	A7 34	10



Tapón hembra - A8

T2

Rosca hembra BSPP	Referencia	Emba.
G 1/8	A8 18	10
G 1/4	A8 14	10
G 3/8	A8 38	10
G 1/2	A8 12	10



ACCESORIOS DE CONEXIÓN CODO - T

Codo hembra - A9

T2

Rosca hembra BSPP	Rosca hembra BSPP	Referencia	Emba.
G 1/8	G 1/8	A9 1818	10
G 1/4	G 1/4	A9 1414	10
G 3/8	G 3/8	A9 3838	10
G 1/2	G 1/2	A9 1212	10
G 3/4	G 3/4	A9 3434	1
G 1	G 1	A9 0101	1



ACCESORIOS DE CONEXIÓN CODO - T

T igual hembra - A11

T2

Rosca hembra BSPP	Referencia	Emba.
G 1/8	A11 18	10
G 1/4	A11 14	10
G 3/8	A11 38	10
G 1/2	A11 12	1
G 3/4	A11 34	1
G 1	A11 01	1
G 1 1/4	A11 42	1
G 1 1/2	A11 49	1
G 2	A11 60	1



Codo macho - A33

T2

Rosca macho BSPT	Rosca macho BSPT	Referencia	Emba.
R 1/8	R 1/8	A33 18	10
R 1/4	R 1/4	A33 14	10
R 3/8	R 3/8	A33 38	10
R 1/2	R 1/2	A33 12	10
R 3/4	R 3/4	A33 34	10
R 1	R 1	A33 01	1



T igual macho cónico - A30

T2

Rosca macho BSPT	Referencia	Emba.
R 1/8	A30 18	10
R 1/4	A30 14	10
R 3/8	A30 38	10
R 1/2	A30 12	1
R 3/4	A30 34	1



Codo macho cónico / hembra cilíndrica - A10

T2

Rosca macho BSPT	Rosca hembra BSPP	Referencia	Emba.
R 1/8	G 1/8	A10 1818	10
R 1/4	G 1/4	A10 1414	10
R 3/8	G 3/8	A10 3838	10
R 1/2	G 1/2	A10 1212	10
R 3/4	G 3/4	A10 3434	1
R 1	G 1	A10 0101	1



T igual hembra / macho cónico en el centro - A12

T2

Rosca hembra BSPP	Rosca macho BSPT	Referencia	Emba.
G 1/8	R 1/8	A12 1818	10
G 1/4	R 1/4	A12 1414	10
G 3/8	R 3/8	A12 3838	10
G 1/2	R 1/2	A12 1212	1
G 3/4	R 3/4	A12 3434	1
G 1	R 1	A12 0101	1



ACCESORIOS DE CONEXIÓN CODO - T

T igual macho cónico / hembra cilíndrica en el centro - A31 T2

Rosca macho BSPT	Rosca hembra BSPP	Referencia	Emba.
R 1/8	G 1/8	A31 1818	10
R 1/4	G 1/4	A31 1414	10
R 3/8	G 3/8	A31 3838	10
R 1/2	G 1/2	A31 1212	1
R 3/4	G 3/4	A31 3434	1



T igual hembra / hembra, macho cónico lateral - A13 T2

Rosca hembra BSPP	Rosca macho BSPT	Referencia	Emba.
G 1/8	R 1/8	A13 1818	10
G 1/4	R 1/4	A13 1414	10
G 3/8	R 3/8	A13 3838	10
G 1/2	R 1/2	A13 1212	1
G 3/4	R 3/8	A13 3434	1
G 1	R 1	A13 0101	1



T igual macho / macho cónico, hembra lateral - A32 T2

Rosca macho BSPT	Rosca hembra BSPP	Referencia	Emba.
R 1/8	G 1/8	A32 1818	10
R 1/4	G 1/4	A32 1414	10
R 3/8	G 3/8	A32 3838	10
R 1/2	G 1/2	A32 1212	1
R 3/4	G 3/4	A32 3434	1



ACCESORIOS DE CONEXIÓN TAPÓN - FORRO - Y

Tapón hexagonal cilíndrico rosca macho - A20 T2

Rosca macho BSPP	Fijación	Referencia	Emba.
G 1/8	Llave BTR de 5	A20 18	10
G 1/4	Llave BTR de 6	A20 14	10
G 3/8	Llave BTR de 8	A20 38	10
G 1/2	Llave BTR de 10	A20 12	10



Pasatabiques hembra / hembra - A21 T2

Rosca hembra BSPP	Espesor del tabique (mm)	Ø de taladrado (mm)	Referencia	Emba.
G 1/8	10	16	A21 18	1
G 1/4	12	20	A21 14	1
G 3/8	12	26	A21 38	1
G 1/2	12	28	A21 12	1



Forro T2

Rosca macho BSPP	Rosca hembra BSPP	Referencia	Emba.
G 1/4	G 1/8	FOU 1014	10
G 3/8	G 1/4	FOU 1417	10
G 1/2	G 1/4	FOU 1421	10
G 1/2	G 3/8	FOU 1721	10
G 3/4	G 1/2	FOU 2127	10
G 1	G 3/4	FOU 2734	10



ACCESORIOS DE CONEXIÓN TAPÓN - FORRO - Y

Enchufe en Y igual rosca hembra cilíndrica

T2

Entrada rosca hembra BSPP	Salida rosca hembra BSPP	Referencia	Emba.
G 1/8	G 1/8	Y18	10
G 1/4	G 1/4	Y14	10
G 3/8	G 3/8	Y38	10
G 1/2	G 1/2	Y12	1
G 3/4	G 3/4	Y34	1

Enchufe en Y macho cónico en el centro / hembra cilíndrica x2 - YM

T2

Entrada rosca macho BSPT	Salida rosca hembra BSPP	Referencia	Emba.
R 1/8	G 1/8	Y18M	10
R 1/4	G 1/4	Y14M	10
R 3/8	G 3/8	Y38M	10
R 1/2	G 1/2	Y12M	1

ACCESORIOS DE CONEXIÓN CRUZ - CAPERUZAS - BLOQUES DE DERIVACIÓN

Cruz igual hembra - A14

T2

Rosca hembra BSPP	Referencia	Emba.
G 1/8	A14 18	10
G 1/4	A14 14	10
G 3/8	A14 38	10
G 1/2	A14 12	1

Cruz igual macho cilíndrico en el centro / hembra cilíndrica - A34

T2

Rosca macho BSPT	Rosca hembra BSPP	Referencia	Emba.
R 1/8	G 1/8	A34 1818	10
R 1/4	G 1/4	A34 1414	10
R 3/8	G 3/8	A34 3838	10
R 1/2	G 1/2	A34 1212	1

ACCESORIOS DE CONEXIÓN CRUZ - CAPERUZAS - BLOQUES DE DERIVACIÓN

Caperuza para tubería - Rosca macho cilíndrico G 1/4 BSPP - CO

T2

Para tubería Ø int./ext.	Referencia	Emba.
6 x 12	CO 0612	1
8 x 14	CO 0814	1
9 x 15	CO 0915	1
10 x 16	CO 1016	1

Presión : 10 bar máximo
Los enchufes de sujeción están compuestos de 2 piezas

Bloque de derivación hembra - A15

T2

Rosca hembra BSPP	Referencia	Emba.
G 1/8	A15 18	1
G 1/4	A15 14	1
G 3/8	A15 38	1
G 1/2	A15 12	1

Material : aluminio

Bloque de derivación hembra - A16

T2

Entrada rosca hembra BSPP	Salida rosca hembra BSPP	Referencia	Emba.
2 x G 3/8	2 x G 1/4	A16 3814S2	1
2 x G 3/8	3 x G 1/4	A16 3814S3	1
2 x G 3/8	4 x G 1/4	A16 3814S4	1
2 x G 3/8	5 x G 1/4	A16 3814S5	1
2 x G 3/8	6 x G 1/4	A16 3814S6	1

Material : aluminio
Centros de salida : 36 mm

ROTULAS

Rotulas orientables para aire comprimido

T2

Entrada	Salida rosca macho BSPP	Referencia	Emba.
G 1/4 H	G 1/4	PFA 085101	1
G 3/8 H	G 1/4	PFA 085102	1
Para tubería Ø 6 mm	G 1/4	PFA 085106	1
Para tubería Ø 8 mm	G 1/4	PFA 085108	1
Para tubería Ø 10 mm	G 1/4	PFA 085110	1



SURTIDO DE ACCESORIOS DE CONEXIÓN

Caja surtida de accesorios de conexión

T2

Composición	Referencia	Emba.
Caja de 105 accesorios de conexión :	MAL PA105	1
5 x JPC 1408		
5 x JPC 1410		
5 x JPC 3810		
5 x JDT 0606		
5 x JDT 0808		
5 x JDT 1010		
5 x A4 1418		
5 x A4 3818		
5 x A3 18		
5 x A3 14		
5 x A2 1414		
5 x A2 1438		
5 x A2 1412		
5 x A4 3814		
5 x A4 1214		
5 x A3 38		
5 x A2 3838		
5 x A2 3812		
5 x A4 1238		
5 x A3 12		
5 x A2 1212		



PIEZAS DE CONEXIÓN ACERO INOX

Unión rosca macho cilíndrico para tubo

T6

Rosca macho BSPP	Para tubo Ø int. (mm)	Referencia	Emba.
G 1/4	6	JFT 1406I	1
G 1/4	8	JFT 1408I	1
G 1/4	10	JFT 1410I	1
G 1/4	12	JFT 1412I	1

Material : Acero inoxidable 316 L



Tetón igual cónico

T6

Rosca macho BSPT	Rosca macho BSPT	Referencia	Emba.
R 1/8	R 1/8	A1 1818I	1
R 1/4	R 1/4	A1 1414I	1
R 3/8	R 3/8	A1 3838I	1
R 1/2	R 1/2	A1 1212I	1
R 3/4	R 3/4	A1 3434I	1

Material : Acero inoxidable 316 L



Tetón desigual cónico

T6

Rosca macho BSPT	Rosca macho BSPT	Referencia	Emba.
R 1/8	R 1/4	A1 1814I	1
R 1/4	R 3/8	A1 1438I	1
R 3/8	R 1/2	A1 3812I	1
R 1/2	R 3/4	A1 1234I	1

Material : Acero inoxidable 316 L



Enchufe macho cilíndrico giratorio / hembra (una pieza)

T6

Rosca macho BSPP	Rosca hembra BSPP	Referencia	Emba.
G 1/2	G 1/2	A35 1212I	1
G 1/2	G 3/4	A35 1234I	1

Material : acero inoxidable 316L



UNIONES PARA TUBOS FLEXIBLES

Unión rosca cónico

T2

Rosca macho BSPT	Para tubo Ø int. (mm)	Referencia	Emba.
R 1/8	4	JPL 1804	10
R 1/4	4	JPL 1404	10
R 1/8	6	JPL 1806	10
R 1/4	6	JPL 1406	10
R 3/8	6	JPL 3806	10
R 1/4	8	JPL 1408	10
R 3/8	8	JPL 3808	10
R 1/2	8	JPL 1208	10
R 1/4	10	JPL 1410	10
R 3/8	10	JPL 3810	10
R 3/8	12	JPL 3812	10
R 1/2	12	JPL 1212	10
Material : Poliamida			

Codo macho 90° cónico

T2

Rosca macho BSPT	Para tubo Ø int. (mm)	Referencia	Emba.
R 1/8	4	JPL 51804	10
R 1/4	4	JPL 51404	10
R 1/8	6	JPL 51806	10
R 1/4	6	JPL 51406	10
R 3/8	6	JPL 53806	10
R 1/8	8	JPL 51808	10
R 1/4	8	JPL 51408	10
R 3/8	8	JPL 53808	10
R 1/4	10	JPL 51410	10
R 3/8	10	JPL 53810	10
Material : Poliamida			

T macho en el centro cónico

T2

Rosca macho BSPT	Para tubo Ø int. (mm)	Referencia	Emba.
R 1/8	4	JPL 71804	10
R 1/4	4	JPL 71404	10
R 1/8	6	JPL 71806	10
R 1/4	6	JPL 71406	10
R 1/4	8	JPL 71408	10
R 3/8	10	JPL 73810	10
Material : Poliamida			

UNIONES PARA TUBOS FLEXIBLES

Unión doble para tubo

T2

Para tubo Ø int. (mm)	Referencia	Emba.
4	JPL 34	10
6	JPL 36	10
8	JPL 38	10
10	JPL 310	10
Material : Resina Acetal		

Codo igual 90°

T2

Para tubo Ø int. (mm)	Referencia	Emba.
4	JPL 64	10
6	JPL 66	10
8	JPL 68	10
10	JPL 610	10
Material : Resina Acetal		

T igual para tubo

T2

Para tubo Ø int. (mm)	Referencia	Emba.
4	JPL 94	10
6	JPL 96	10
8	JPL 98	10
10	JPL 910	10
Material : Resina Acetal		

Y

T2

Para tubo Ø int. (mm)	Referencia	Emba.
4	JPL Y4	10
6	JPL Y6	10
8	JPL Y8	10
10	JPL Y10	10
Material : Resina Acetal		

Cruz igual

T2

Para tubo Ø int. (mm)	Referencia	Emba.
4	JPL X4	10
6	JPL X6	10
Material : Resina Acetal		

VÁLVULAS DE MANGUITO ESFÉRICO

Válvulas latón hembra / hembra PN 40

T2

Rosca hembra BSPP	Presión máx de uso (bar)	Referencia	Emba.
G 1/4	40	RSI 13	1
G 3/8	40	RSI 17	1
G 1/2	40	RSI 21	1
G 3/4	40	RSI 27	1
G 1	40	RSI 34	1
G 1 1/4	32	RSI 42	1
G 1 1/2	32	RSI 49	1
G 2	32	RSI 60	1
G 2 1/2	25	RSI 76	1
G 3	25	RSI 90	1

VÁLVULAS DE MANGUITO ESFÉRICO

Válvulas de descompresión rosca cilíndrica hembra / hembra PN 40

T2

Rosca hembra BSPP	Referencia	Emba.
G 1/4	VDA 13	1
G 3/8	VDA 17	1
G 1/2	VDA 21	1
G 3/4	VDA 27	1
G 1	VDA 34	1
Sistema de descompresión automática		

Válvulas latón cilíndrica macho / macho PN 40

T2

Rosca macho BSPP	Referencia	Emba.
G 3/8	RSIM 17	1
G 1/2	RSIM 21	1
G 3/4	RSIM 27	1
G 1	RSIM 34	1

Válvulas Inox con candado cilíndrica de descompresión

T6

Rosca hembra BSPP	Referencia	Emba.
G 3/4	VICA 27	1
Sistema de descompresión automática Presión : 6 bar Material : Acero inoxidable 316 L		

Válvulas latón rosca cilíndrica macho / hembra PN 40

T2

Rosca macho BSPP	Rosca hembra BSPP	Referencia	Emba.
G 1/4	G 1/4	RSIMF 13	1
G 3/8	G 3/8	RSIMF 17	1
G 1/2	G 1/2	RSIMF 21	1
G 3/4	G 3/4	RSIMF 27	1
G 1	G 1	RSIMF 34	1

Candado de llave

T1

Dénominación	Referencia	Emba.
Bucle 30 mm	CADENAS	1

Válvulas mariposa rosca cilíndrica macho / macho PN40

T2

Rosca macho BSPP	Referencia	Emba.
G 1/2	RSIM 21PAP	1
G 3/4	RSIM 27PAP	1

Válvulas de dos grifos hembra BSPP

T2

Rosca hembra BSPP	Rosca hembra BSPP	Referencia	Emba.
G 1/2	2 x G 3/8	RD 17	1
G 3/4	2 x G 1/2	RD 21	1
G 1	2 x G 3/4	RD 27	1
G 1 1/4	2 x G 1	RD 34	1
Presión : 16 bar Temperatura de uso : desde -10°C hasta +110°C			

OTRAS VÁLVULAS

Miniválvulas mariposa hembra / hembra cilíndrico PN 16 T2

Rosca hembra BSPP	Referencia	Emba.
G 1/8	FSI 10	1
G 1/4	FSI 13	1
G 3/8	FSI 17	1
G 1/2	FSI 21	1
Paso reducido Temperatura de uso : desde - 10°C hasta +90°C Material : Latón cromado		

Miniválvulas mariposa macho / hembra cilíndrica PN 16 T2

Rosca macho BSPP	Rosca hembra BSPP	Referencia	Emba.
G 1/8	G 1/8	MSI 10	1
G 1/4	G 1/4	MSI 13	1
G 3/8	G 3/8	MSI 17	1
G 1/2	G 1/2	MSI 21	1
Paso reducido Temperatura de uso : desde -10°C hasta +90°C Material : Latón cromado			

Válvulas deslizantes hembra / hembra PN 10 T2

Rosca hembra BSPP	Referencia	Emba.
G 1/4	A17 14	1
G 3/8	A17 38	1
Presión : 10 bar máximo Temperatura de uso : desde -10°C hasta +80°C		

ACCESORIOS DE LÍNEA

Válvula antirretorno T2

Rosca hembra BSPP	Presión de uso (bar)	Temperatura (°C)	Referencia	Emba.
G 1/8	1 à 10	-10 a +130 máximo	A24 18	1
G 1/4	1 à 10	-10 a +130 máximo	A24 14	1
G 3/8	1 à 10	-10 a +130 máximo	A24 38	1
G 1/2	1 à 10	-10 a +130 máximo	A24 12	1

Válvula antirretorno T2

Rosca hembra BSPP	Presión máx de uso (bar)	Temperatura (°C)	Referencia	Emba.
G 3/4	25	- 20°C hasta + 100°C	A24 34	1

Válvula de escape rápido T2

Rosca hembra BSPP	Presión máx de uso (bar)	Temperatura (°C)	Referencia	Emba.
G 1/8	10	70	A25 18	1
G 1/4	10	70	A25 14	1
G 3/8	10	70	A25 38	1
G 1/2	10	70	A25 12	1
G 3/4	10	70	A25 34	1

VÁLVULA PROGRAMABLE

Válvula programable T2

Dénominación	Referencia	Emba.
Válvula programable	VPS 34	1
Rosca hembra : G 1 BSPP 230 V AC 50 Hz - 60 Hz Válvula provista de un temporizador que permite abrir y cerrar la red de aire comprimido programable (24 horas y los 7 días de la semana). Tiempo de apertura y cierre : 30 s. Temperatura ambiente máx : 50°C Temperatura máx. : 100°C Protección IP 54		

Limitador de caudal T2

Rosca macho BSPT	Rosca hembra BSPP	Referencia	Emba.
R 1/4	G 1/4	RG DT14	1
Reductor de caudal de aire por disminución del diámetro de paso			

Purga manual T1

Rosca macho BSPP	Referencia	Emba.
G 1/8	MA 18	1
G 1/4	MA 14	1
G 3/8	MA 38	1

SILENCIADORES

Silenciador de escape macho cilíndrico

T2

Rosca macho	Referencia	Emba.
M5 x 0,8	PPS M5	1
G 1/8	PPS 18	1
G 1/4	PPS 14	1
G 3/8	PPS 38	1
G 1/2	PPS 12	1
G 3/4	PPS 34	1

Silenciador de escape macho cilíndrico

T2

Rosca macho BSPP	Referencia	Emba.
G 1/8	PPB 18	1
G 1/4	PPB 14	1
G 3/8	PPB 38	1
G 1/2	PPB 12	1
G 3/4	PPB 34	1
G 1	PPB 01	1

Silenciador de escape macho plano cilíndrico

T2

Rosca macho	Referencia	Emba.
M5 x 0,8	PPC M5	1
G 1/8	PPC 18	1
G 1/4	PPC 14	1
G 3/8	PPC 38	1
G 1/2	PPC 12	1
G 3/4	PPC 34	1

Silenciador de escape macho plano reductor de cauda

T2

Rosca macho BSPP	Referencia	Emba.
G 1/8	A26 18	1
G 1/4	A26 14	1
G 3/8	A26 38	1

Silenciador de escape reductor de caudal

T2

Rosca macho BSPP	Referencia	Emba.
G 1/8	A27 18	1
G 1/4	A27 14	1
G 3/8	A27 38	1

SILENCIADORES

Silenciador de escape macho cilíndrico - PPP

T2

Rosca macho	Referencia	Emba.
M5	PPP M5	1
G 1/8	PPP 18	1
G 1/4	PPP 14	1
G 3/8	PPP 38	1
G 1/2	PPP 12	1
G 3/4	PPP 34	1
G 1	PPP 01	1

PRODUCTOS DE ESTANQUEIDAD

Producto de estanqueidad

T2

Dénominación	Referencia	Emba.
Tubo de producto de estanqueidad	ETANCHE 177	1
Contenido : 50 g Estanqueidad : 2 horas con roscas de G 1/8 a G 1 BSPP Tiempo de fraguado : inmediato a 25°C Resistencia a la presión : 6 bar Materiales a ensamblar : acero y latón niquelado Color : violeta Resistencia al cizallamiento : 17-23 N/mm ² tra 24 horas No tóxico		

Rodillo de cinta estanqueidad PTFE

T2

Long. (metros)	Anchura (mm)	Espesor (mm)	Referencia	Emba.
12	12	0,076	TEFLON 12	1

Fibra estanqueidad

T2

Dénominación	Referencia	Emba.
Fibra multifilamentos impregnada Cinta de estanqueidad 100 % PTFE	FLT 150	1
Longitud : 150 metros en la caja /enrollador de plástico Presión máxima de servicio : - Aire comprimido : 7.5 bar - Agua : 16 bar - Gas : 5 bar Compatible con Aire, agua, Gas natural		

Redes de aire comprimido

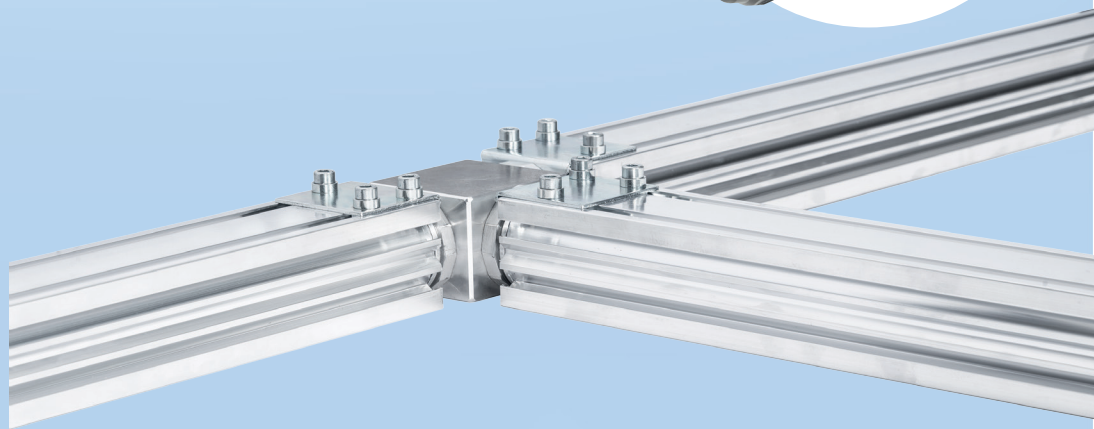

Tubos y enchufes para redes PPS	87 - 93
Aplicques murales	93 - 96
Pletinas equipados para vigas HEA	96 - 98
Tubos y enchufes para redes en aluminio AMPS	98 - 101
Tubos y enchufes para redes PVR	102 - 106
Válvulas de seguridad	106

CONCEPTO PPS REDES TODO ALUMINIO

PPS - Tubo de aluminio azul para aire comprimido

T4

NUEVO	Tubo Ø ext. (mm)	Long. (m)	Referencia	Emba.
	16	4	PPS TUB16L4	4
	20	4	PPS TUB20L4	4
	20	6	PPS TUB20L6	6
	25	4	PPS TUB25L4	4
	25	6	PPS TUB25L6	6
	32	4	PPS TUB32L4	4
	32	6	PPS TUB32L6	6
	40	4	PPS TUB40L4	4
	40	6	PPS TUB40L6	6
	50	6	PPS TUB50L6	6
	63	6	PPS TUB63L6	6
	80	6	PPS TUB80L6	6

Precio por metro

PPS - Tubo de aluminio gris para vacío

T4

NUEVO	Tubo Ø ext. (mm)	Long. (m)	Referencia	Emba.
	16	4	PPS TUG16L4	4
	20	6	PPS TUG20L6	6
	25	6	PPS TUG25L6	6
	32	6	PPS TUG32L6	6
	40	6	PPS TUG40L6	6
	50	6	PPS TUG50L6	6
	63	6	PPS TUG63L6	6
	80	6	PPS TUG80L6	6

Precio por metro

PPS - Tubo de aluminio verde para nitrógeno

T4

NUEVO	Tubo Ø ext. (mm)	Long. (m)	Referencia	Emba.
	20	6	PPS TUV20L6	6
	25	6	PPS TUV25L6	6

Precio por metro

PPS - Tubo de enlace curvado

T4

	Tubo Ø ext. (mm)	Referencia	Emba.
	16	PPS LMCB16	1
	20	PPS LMCB20	1
	25	PPS LMCB25	1

CONCEPTO PPS REDES TODO ALUMINIO

PPS1 UN - Unión simple de aluminio para tubo

T4

NUEVO	Para tubo Ø ext. (mm)	Referencia	Emba.
	16	PPS1 UN16	1
	20	PPS1 UN20	1
	25	PPS1 UN25	1
	32	PPS1 UN32	1
	40	PPS1 UN40	1
	50	PPS1 UN50	1
	63	PPS1 UN63	1
	80	PPS1 UN80	1

PPS1 UNS - Unión deslizante de aluminio para tubo

T4

NUEVO	Para tubo Ø ext. (mm)	Referencia	Emba.
	25	PPS1 UNS25	1
	32	PPS1 UNS32	1
	40	PPS1 UNS40	1
	50	PPS1 UNS50	1
	63	PPS1 UNS63	1
	80	PPS1 UNS80	1

PPS1 MR - Reducción para tubo

T4

NUEVO	Para tubo Ø ext. (mm)	Para tubo Ø ext. (mm)	Referencia	Emba.
	25	20	PPS1 MR2520	1
	32	25	PPS1 MR3225	1
	40	32	PPS1 MR4032	1
	50	40	PPS1 MR5040	1
	63	50	PPS1 MR6350	1
	80	63	PPS1 MR8063	1

PPS1 9C - Codo igual 90° de aluminio para tubo

T4

NUEVO	Para tubo Ø ext. (mm)	Referencia	Emba.
	16	PPS1 9C16	1
	20	PPS1 9C20	1
	25	PPS1 9C25	1
	32	PPS1 9C32	1
	40	PPS1 9C40	1
	50	PPS1 9C50	1
	63	PPS1 9C63	1
	80	PPS1 9C80	1

CONCEPTO PPS REDES TODO ALUMINIO

PPS1 9CM - Codo 90° rosca macho cónica para tubo T4

NUEVO	Para tubo Ø ext. (mm)	Rosca macho BSPT	Referencia	Emba.
	16	R 3/8	PPS1 9CM1617	1
	16	R 1/2	PPS1 9CM1612	1
	20	R 1/2	PPS1 9CM2012	1
	25	R 1/2	PPS1 9CM2512	1
	25	R 3/4	PPS1 9CM2527	1
	32	R 1	PPS1 9CM3234	1
	40	R 1 1/4	PPS1 9CM4042	1
	40	R 1 1/2	PPS1 9CM4049	1

PPS1 4C - Codo igual 45° de aluminio para tubo T4

NUEVO	Para tubo Ø ext. (mm)	Referencia	Emba.
	16	PPS1 4C16	1
	20	PPS1 4C20	1
	25	PPS1 4C25	1
	32	PPS1 4C32	1
	40	PPS1 4C40	1

PPS1 BO - Tapón de aluminio para tubo T4

NUEVO	Para tubo Ø ext. (mm)	Referencia	Emba.
	16	PPS1 B016	1
	20	PPS1 B020	1
	25	PPS1 B025	1
	32	PPS1 B032	1
	40	PPS1 B040	1
	50	PPS1 B050	1
	63	PPS1 B063	1
	80	PPS1 B080	1

CONCEPTO PPS REDES TODO ALUMINIO

PPS1 TE - Te igual de aluminio para tubo T4

NUEVO	Para tubo Ø ext. (mm)	Referencia	Emba.
	16	PPS1 TE16	1
	20	PPS1 TE20	1
	25	PPS1 TE25	1
	32	PPS1 TE32	1
	40	PPS1 TE40	1
	50	PPS1 TE50	1
	63	PPS1 TE63	1
	80	PPS1 TE80	1

PPS1 TR - Te reducida hembra T4

NUEVO	Para tubo Ø ext. (mm)	Para tubo Ø ext. (mm)	Referencia	Emba.
	20	16	PPS1 TR2016	1
	25	16	PPS1 TR2516	1
	25	20	PPS1 TR2520	1
	32	16	PPS1 TR3216	1
	32	32	PPS1 TR3220	1
	32	25	PPS1 TR3225	1

PPS1 TT - Te de aluminio rosca hembra central para tubo T4

NUEVO	Para tubo Ø ext. (mm)	Rosca hembra BSPP	Referencia	Emba.
	16	G 3/8	PPS1 TT1617	1
	20	G 1/2	PPS1 TT2012	1
	25	G 1/2	PPS1 TT2512	1
	25	G 3/4	PPS1 TT2527	1
	32	G 3/4	PPS1 TT3227	1
	32	G 1	PPS1 TT3234	1
	40	G 3/4	PPS1 TT4027	1
	40	G 1	PPS1 TT4034	1
	40	G 1 1/4	PPS1 TT4042	1
	50	G 1	PPS1 TT5034	1
	50	G 1 1/4	PPS1 TT5042	1
	50	G 1 1/2	PPS1 TT5049	1
	63	G 1	PPS1 TT6334	1
	63	G 1 1/4	PPS1 TT6342	1
	63	G 1 1/2	PPS1 TT6349	1
	63	G 2	PPS1 TT6360	1
	80	G 1	PPS1 TT8034	1
	80	G 1 1/2	PPS1 TT8049	1
	80	G 2	PPS1 TT8060	1
	80	G 2 1/2	PPS1 TT8076	1

CONCEPTO PPS REDES TODO ALUMINIO

PPS1 MM - Racor recto rosca macho cónico de aluminio para tubo

T4

NUEVO	Para tubo Ø ext. (mm)	Rosca macho BSPT	Referencia	Emba.
	16	R 3/8	PPS1 MM1617	1
	16	R 1/2	PPS1 MM1612	1
	20	R 1/2	PPS1 MM2012	1
	20	R 3/4	PPS1 MM2027	1
	25	R 1/2	PPS1 MM2512	1
	25	R 3/4	PPS1 MM2527	1
	25	R 1	PPS1 MM2534	1
	32	R 1	PPS1 MM3234	1
	32	R 1 1/4	PPS1 MM3242	1
	40	R 1 1/4	PPS1 MM4042	1
	40	R 1 1/2	PPS1 MM4049	1
	50	R 1 1/2	PPS1 MM5049	1
	50	R 2	PPS1 MM5060	1
	63	R 2	PPS1 MM6360	1
	63	R 2 1/2	PPS1 MM6376	1
	80	R 2 1/2	PPS1 MM8076	1
	80	R 3	PPS1 MM8090	1



PPS1 MF - Racor rosca hembra cilíndrica aluminio para tubo

T4

NUEVO	Para tubo Ø ext. (mm)	Rosca hembra BSPP	Referencia	Emba.
	16	G 3/8	PPS1 MF1617	1
	16	G 1/2	PPS1 MF1612	1
	20	G 1/2	PPS1 MF2012	1
	20	G 3/4	PPS1 MF2027	1
	25	G 1/2	PPS1 MF2512	1
	25	G 3/4	PPS1 MF2527	1
	25	G 1	PPS1 MF2534	1
	32	G 1	PPS1 MF3234	1
	32	G 1 1/4	PPS1 MF3242	1
	40	G 1 1/4	PPS1 MF4042	1
	40	G 1 1/2	PPS1 MF4049	1
	50	G 1 1/2	PPS1 MF5049	1
	50	G 2	PPS1 MF5060	1
	63	G 2	PPS1 MF6360	1
	63	G 2 1/2	PPS1 MF6376	1
	80	G 2 1/2	PPS1 MF8076	1
	80	G 3	PPS1 MF8090	1



CONCEPTO PPS REDES TODO ALUMINIO

PPS1 RSIF - Válvulas rosca hembra cilíndrica con conexión para tubo

T4

NUEVO	Para tubo Ø ext. (mm)	Rosca hembra BSPP	Referencia	Emba.
	16	G 1/2	PPS1 RSIF1612	1
	20	G 1/2	PPS1 RSIF2012	1
	25	G 3/4	PPS1 RSIF2527	1
	32	G 1	PPS1 RSIF3234	1
	40	G 1 1/4	PPS1 RSIF4042	1
	50	G 1 1/2	PPS1 RSIF5049	1
	63	G 2	PPS1 RSIF6360	1
	80	G 2 1/2	PPS1 RSIF8076	1
	Cuerpo Latón			



PPS1 RSIM - Válvulas rosca macho cónico con conexión para tubo

T4

NUEVO	Para tubo Ø ext. (mm)	Rosca macho BSPT	Referencia	Emba.
	16	R 1/2	PPS1 RSIM1612	1
	20	R 1/2	PPS1 RSIM2012	1
	25	R 3/4	PPS1 RSIM2527	1
	32	R 1	PPS1 RSIM3234	1
	40	R 1 1/4	PPS1 RSIM4042	1
	50	R 1 1/2	PPS1 RSIM5049	1
	Cuerpo Latón			



PPS1 RSI - Válvula esférica para tubos

T4

NUEVO	Para tubo Ø ext. (mm)	Referencia	Emba.
	16	PPS1 RSI16	1
	20	PPS1 RSI20	1
	25	PPS1 RSI25	1
	32	PPS1 RSI32	1
	40	PPS1 RSI40	1
	50	PPS1 RSI50	1
	63	PPS1 RSI63	1
	80	PPS1 RSI80	1
	Cuerpo Latón		



CONCEPTO PPS REDES TODO ALUMINIO

PPS1 BP - Brida de derivación aluminio para tubo

T4

NUEVO	Para tubo Ø ext. (mm)	Para tubo Ø ext. (mm)	Referencia	Emba.
	25	16	PPS1 BP2516	1
	25	20	PPS1 BP2520	1
	32	16	PPS1 BP3216	1
	32	20	PPS1 BP3220	1
	40	16	PPS1 BP4016	1
	40	20	PPS1 BP4020	1
	40	25	PPS1 BP4025	1
	50	16	PPS1 BP5016	1
	50	20	PPS1 BP5020	1
	50	25	PPS1 BP5025	1
	63	20	PPS1 BP6320	1
	63	25	PPS1 BP6325	1
	63	32	PPS1 BP6332	1
	80	20	PPS1 BP8020	1
	80	25	PPS1 BP8025	1
	80	32	PPS1 BP8032	1



PPS1 BT - Brida de derivación rosca hembra cilíndrica para tubo

T4

NUEVO	Para tubo Ø ext. (mm)	Rosca hembra BSPP	Referencia	Emba.
	25	G 3/8	PPS1 BT2517	1
	25	G 1/2	PPS1 BT2512	1
	32	G 1/2	PPS1 BT3212	1
	32	G 3/4	PPS1 BT3227	1
	40	G 1/2	PPS1 BT4012	1
	40	G 3/4	PPS1 BT4027	1
	40	G 1	PPS1 BT4034	1
	50	G 1/2	PPS1 BT5012	1
	50	G 3/4	PPS1 BT5027	1
	50	G 1	PPS1 BT5034	1
	63	G 1/2	PPS1 BT6312	1
	63	G 3/4	PPS1 BT6327	1
	63	G 1	PPS1 BT6334	1
	80	G 1/2	PPS1 BT8012	1
	80	G 3/4	PPS1 BT8027	1
	80	G 1	PPS1 BT8034	1



CONCEPTO PPS REDES TODO ALUMINIO

PPS1 NUT - Tuerca aluminio

T4

NUEVO	Para racor Ø (mm)	Referencia	Emba.
	16	PPS1 NUT16	1
	20	PPS1 NUT20	1
	25	PPS1 NUT25	1
	32	PPS1 NUT32	1
	40	PPS1 NUT40	1
	50	PPS1 NUT50	1
	63	PPS1 NUT63	1
	80	PPS1 NUT80	1



PPS1 SEAL - Junta

T4

NUEVO	Para racor Ø (mm)	Composición	Referencia	Emba.
	16	10	PPS1 SEAL16	1
	20	10	PPS1 SEAL20	1
	25	10	PPS1 SEAL25	1
	32	10	PPS1 SEAL32	1
	40	5	PPS1 SEAL40	1
	50	5	PPS1 SEAL50	1
	63	2	PPS1 SEAL63	1
	80	2	PPS1 SEAL80	1



PPS1 IP - Kit de partes internas

T4

NUEVO	Para racor Ø (mm)	Referencia	Emba.
	16	PPS1 IP16	1
	20	PPS1 IP20	1
	25	PPS1 IP25	1
	32	PPS1 IP32	1
	40	PPS1 IP40	1
	50	PPS1 IP50	1
	63	PPS1 IP63	1
	80	PPS1 IP80	1



A3T - Manguito igual cilíndrico hembra giratorio (3 piezas)

T4

Rosca hembra BSPP	Referencia	Emba.
G 1	A3T 01	1
G 1 1/4	A3T 42	1
G 1 1/2	A3T 49	1
G 2	A3T 60	1



ACCESORIOS PARA MONTAJE PARA REDES PPS

PPS1 CLE - Llave de apriete

T4

NUEVO	Para racor Ø (mm)	Referencia	Emba.
	16	PPS1 CLE16	1
	20	PPS1 CLE20	1
	25	PPS1 CLE25	1
	32	PPS1 CLE32	1
	40	PPS1 CLE40	1
	50	PPS1 CLE50	1
	63	PPS1 CLE63	1
	80	PPS1 CLE80	1

PPS CLESTD - Llave ajustable neutra

T4

NUEVO	Para racor Ø (mm)	Referencia	Emba.
	16 a 80	PPS CLESTD	1

PPS SP - Broca de corona

T4

NUEVO	Ø de taladrado (mm)	Para tubo Ø ext. (mm)	Referencia	Emba.
	16	25 a 32	PPS SP16	1
	22	40 a 50	PPS SP22	1
	30	63 a 80	PPS SP30	1
	Herramienta de perforación para colocar derivación AVR BT y ALR BP			

Herramienta para achaflanar

T4

	Para tubo Ø ext. (mm)	Función	Referencia	Emba.
	16 a 50 (1)	-	PPS CH50	1
	16 a 50 (1)	-	PPS CHP50	1
	63 a 80 (2)	-	PPS CH110	1
	(3) -	Desbarbado interior/ exterior	PPS CHERAP	1

ACCESORIOS PARA MONTAJE PARA REDES PPS

PPS AL - Líquido de ensamblaje

T4

	Capacidad (ml)	Referencia	Emba.
	650	PPS AL	1

PPS CTU - Cortatubos

T4

	Para tubo Ø ext. (mm)	Referencia	Emba.
	16 a 63	PPS CTU63	1
	63 a 80	PPS CTU110	1

PPS1 CI - Abrazaderas de fijación (unidad de venta = 1 caja de 5 orejas)

T4

	Para tubo Ø ext. (mm)	Referencia	Emba.
	16	PPS1 CI16	5
	20	PPS1 CI20	5
	25	PPS1 CI25	5
	32	PPS1 CI32	5
	40	PPS1 CI40	5
	50	PPS1 CI50	5
	63	PPS1 CI63	5
	80	PPS1 CI80	5

Consola metálica de soporte

	Dénominación	Referencia	Emba.
	Long. 180 mm	CS 180L	1
	Long. 300 mm	CS 310L	1
	Long. 420 mm	CS 420L	1
	Long. 510 mm	CS 500	1
	Tornillo de fijación M8 (3) para consola CS 500	CS VIS	1
	Tornillo de fijación (4) para CS 180L - CS 310L - CS 420L	CS VIS2	1

Clips de fijación taladrados M8

T4

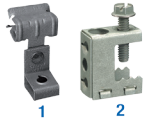
	Espesor del tabique (mm)	Rosca métrica	Referencia	Emba.
	3 a 8 (1)		CP 38	1
	8 a 14 (1)		CP 814	1
	14 a 20 (1)		CP 1420	1
	0 a 16 (2)	M6 o recto	CP 016	1

ACCESORIOS PARA MONTAJE PARA REDES PPS

Tornillo de estrella Ø 6 mm

T4

	Long. (mm)	Referencia	Emba.
	60	TVB 660	10
	90	TVB 690	10

Tornillo a tuerca M8

T4

	Long. (mm)	Referencia	Emba.
	60	TVM 860	10

Taco galvanizado rosca M8

T4

	Long. (mm)	Uso	Rosca métrica	Referencia	Emba.
	50	Para cualquier material de construcción	M8	PV 80	10
	80	Para cualquier material de construcción	M8	PV 880	10

Tira-fondo Ø 8 mm

T4

	Long. (mm)	Referencia	Emba.
	50	TTF 850	10
	80	TTF 880	10

Distanciador M8

T4

	Rosca métrica	Referencia	Emba.
	M8	TL M8	1

Varilla roscada M8

T4

	Dénominación	Rosca métrica	Long. (m)	Referencia	Emba.
	Varilla roscada	M8	1	TF M8100	1
	Unión para esparrago M8	M8	-	TL RM8	1
	Tuerca	M8	-	TE M8	100

MALETINES DE MONTAJE PPS

PPS CK - Maletín de llaves de apriete

T4

	NUEVO	Composición	Referencia	Emba.
		- 1 Llave de apriete Ø 16 mm : PPS1 CLE16 - 1 Llave de apriete Ø 20 mm : PPS1 CLE20 - 1 Llave de apriete Ø 25 mm : PPS1 CLE25 - 1 Llave de apriete Ø 32 mm : PPS1 CLE32 - 1 Boligrafo marcador : PPS PEN	PPS CK1632	1
		- 1 Llave de apriete Ø 40 mm : PPS1 CLE40 - 1 Llave de apriete Ø 50 mm : PPS1 CLE50 - 1 Boligrafo marcador : PPS PEN	PPS CK4050	1
		- 1 Llave de apriete Ø 63 mm : PPS1 CLE63 - 1 Llave de apriete Ø 80 mm : PPS1 CLE80 - 1 Boligrafo marcador : PPS1 PEN	PPS CK6380	1

PPS CT - Herramientas para la preparación del montaje

T4

	NUEVO	Composición	Referencia	Emba.
		- 1 Corta tubos para tubo PPS Ø ext. 16 a 63 mm : PPS CTU63 - 1 Achaflanador para tubo PPS Ø ext. 16 a 50 mm : PPS CH50 - 1 Desbarbador int/ext : PPS CHERAP - 1 Broca de perforación para tubo Ø 16 a 32 mm : PPS SP16 - 1 Broca de perforación para tubo Ø 40 a 50 mm : PPS SP22 - 1 Boligrafo marcador : PPS PEN	PPS CT1650	1

TUBOS FLEXIBLES DE ENLACE

Tubos flexibles de compensación de dilataciones y contracciones de la red - Enchufes macho giratorios

T4

Rosca macho BSPT	Long. (m)	Referencia	Emba.
R 1/2	0,75	LAM 21	1
R 3/4	0,75	LAM 27	1
R 1	0,75	LAM 34	1
R 1 1/4	1,1	LAM 42	1
R 1 1/2	1,25	LAM 49	1
R 2	1	LAM 60	1

Tubos flexibles de enlace - Conexiones hembra giratorias

T4

Rosca hembra BSPP	Long. (m)	Referencia	Emba.
G 3/8	1,5	LEF 17	1
G 1/2	1,5	LEF 21	1
G 3/4	1,5	LEF 27	1
G 1	1,5	LEF 34	1
G 1 1/4	2,2	LEF 42	1
G 1 1/2	2,5	LEF 49	1
G 2	2	LEF 60	1

Tubos flexibles de enlace con cable de acero de seguridad - Conexiones hembra giratorias

T4

Rosca hembra BSPP	Long. (m)	Referencia	Emba.
G 3/8	1,5	LEF 17S	1
G 1/2	1,5	LEF 21S	1
G 3/4	1,5	LEF 27S	1
G 1	1,5	LEF 34S	1

Tubos flexibles de enlace - Conexiones macho giratorias

T4

Rosca macho BSPT	Long. (m)	Referencia	Emba.
R 3/8	1,5	LEM 17	1
R 1/2	1,5	LEM 21	1
R 3/4	1,5	LEM 27	1
R 1	1,5	LEM 34	1
R 1 1/4	2,2	LEM 42	1
R 1 1/2	2,5	LEM 49	1
R 2	2	LEM 60	1

Tubos flexibles de enlace con cable de seguridad - Conexiones macho giratorias

T4

Rosca macho BSPT	Long. (m)	Referencia	Emba.
R 3/8	1,5	LEM 17S	1
R 1/2	1,5	LEM 21S	1
R 3/4	1,5	LEM 27S	1
R 1	1,5	LEM 34S	1

APLIQUES MURALES

Aplique mural rosca hembra - 2 enchufes y purga - Perfil ISO 6150 B - Paso 6 mm

T1

Entrada rosca hembra BSPP	Salida : 2 enchufes	Referencia	Emba.
G 1/2	ISI 06	ISI 068103WK	1
G 3/4	ISI 06	ISI 068104WK	1

Aplique mural rosca hembra - 2 enchufes y purga - Perfil ISO 6150 B - Paso 8 mm

T1

Entrada rosca hembra BSPP	Salida : 2 enchufes	Referencia	Emba.
G 1/2	ISI 08	ISI 088103WK	1
G 3/4	ISI 08	ISI 088104WK	1

Aplique mural rosca hembra - 2 enchufes y purga - Perfil ISO 6150 B - Paso 8 y 6 mm

T1

Entrada rosca hembra BSPP	Salida : 2 enchufes	Referencia	Emba.
G 3/4	ISI 08 ISI 06	ISI 088104WKI6	1

Aplique mural rosca hembra - 2 enchufes y purga - Perfil ISO 6150 B - Paso 11 mm

T1

Entrada rosca hembra BSPP	Salida : 2 enchufes	Referencia	Emba.
G 3/4	ISI 11	ISI 118104WK	1

Aplique mural rosca hembra - 2 enchufes y purga - Perfil ISO 6150 B - Paso 11 y 6 mm

T1

Entrada rosca hembra BSPP	Salida : 2 enchufes	Referencia	Emba.
G 3/4	ISI 11 ISI 06	ISI 118104WKI6	1

APLIQUES MURALES

Aplique mural rosca hembra - 2 enchufes y purga - Perfil ISO 6150 B - Paso 6 mm y Perfil European - Paso 7,4 mm

T1

Entrada rosca hembra BSPP	Salida : 2 enchufes	Referencia	Emba.
G 3/4	ISI 06 ESI 07	ISI 068104WKE7	1



Aplique mural rosca hembra - 2 enchufes y purga - Perfil ISO 6150 B y ISO 6150 C - Paso 6 mm

T1

Entrada rosca hembra BSPP	Salida : 2 enchufes	Referencia	Emba.
G 3/4	ISI 06 CSI 06	ISI 068104WKC6	1



Aplique mural rosca hembra - 2 enchufes y purga - Perfil ISO 6150 B - ISG - Paso 11 mm

T1

Entrada rosca hembra BSPP	Salida : 2 enchufes	Referencia	Emba.
G 3/4	ISG 11	ISG 118104WK	1



Aplique mural rosca hembra - 2 enchufes y purga - Perfil ISO 6150 B - ISG - Paso 11 mm y ISI Paso 6 mm

T1

Entrada rosca hembra BSPP	Salida : 2 enchufes	Referencia	Emba.
G 3/4	ISG 11 ISI 06	ISG 118104WKI6	1



Aplique mural rosca hembra - 2 enchufes y purga - Perfil European - Paso 7,4 mm

T1

Entrada rosca hembra BSPP	Salida : 2 enchufes	Referencia	Emba.
G 1/2	ESI 07	ESI 078103WK	1
G 3/4	ESI 07	ESI 078104WK	1



APLIQUES MURALES

Aplique mural rosca hembra - 2 enchufes y purga - Perfil European - Paso 10,4 mm

T1

Entrada rosca hembra BSPP	Salida : 2 enchufes	Referencia	Emba.
G 3/4	ESI 11	ESI 118104WK	1



Aplique mural rosca hembra - 2 enchufes y purga - Perfil European - Paso 10,4 mm y 7,4 mm

T1

Entrada rosca hembra BSPP	Salida : 2 enchufes	Referencia	Emba.
G 3/4	ESI 11 ESI 07	ESI 118104WKE7	1



Aplique mural rosca hembra - 2 enchufes y purga - Perfil ISO 6150 C - Paso 6 mm

T1

Entrada rosca hembra BSPP	Salida : 2 enchufes	Referencia	Emba.
G 1/2	CSI 06	CSI 068103WK	1
G 3/4	CSI 06	CSI 068104WK	1



Aplique mural rosca hembra - 2 enchufes y purga - Perfil ISO 6150 C - Paso 8 mm

T1

Entrada rosca hembra BSPP	Salida : 2 enchufes	Referencia	Emba.
G 1/2	CSI 08	CSI 088103WK	1
G 3/4	CSI 08	CSI 088104WK	1



Aplique mural rosca hembra - 2 enchufes y purga - Perfil ISO 6150 C - Paso 8 mm y 6 mm

T1

Entrada rosca hembra BSPP	Salida : 2 enchufes	Referencia	Emba.
G 3/4	CSI 06 CSI 08	CSI 088104WKC6	1



APLIQUES MURALES SIMPLES

Aplique mural rosca hembra - 1 enchufe y purga -
Perfil ISO 6150 B - Paso 6 mm

T1

	Entrada rosca hembra BSPP	Salida : 1 enchufe	Referencia	Emba.
	G 1/2	ISI 06	ISI 061103WK	1

APLIQUES MURALES SIMPLES

Aplique mural rosca hembra - 1 enchufe y purga -
Perfil European - Paso 7,4 mm

T1

	Entrada rosca hembra BSPP	Salida : 1 enchufe	Referencia	Emba.
	G 1/2	ESI 07	ESI 071103WK	1

Aplique mural rosca hembra - 1 enchufe y purga -
Perfil ISO 6150 B - Paso 8 mm

T1

	Entrada rosca hembra BSPP	Salida : 1 enchufe	Referencia	Emba.
	G 1/2	ISI 08	ISI 081103WK	1

Aplique mural rosca hembra - 1 enchufe y purga -
Perfil European - Paso 10,4 mm

T1

	Entrada rosca hembra BSPP	Salida : 1 enchufe	Referencia	Emba.
	G 1/2	ESI 11	ESI 111103WK	1

Aplique mural rosca hembra - 1 enchufe y purga -
Perfil ISO 6150 B - Paso 11 mm

T1

	Entrada rosca hembra BSPP	Salida : 1 enchufe	Referencia	Emba.
	G 1/2	ISI 11	ISI 111103WK	1

Aplique mural rosca hembra - 1 enchufe y purga -
Perfil ISO 6150 C - Paso 6 mm

T1

	Entrada rosca hembra BSPP	Salida : 1 enchufe	Referencia	Emba.
	G 1/2	CSI 06	CSI 061103WK	1

Aplique mural rosca hembra - 1 enchufe y purga -
Perfil ISO 6150 B - ISG - Paso 11 mm

T1

	Entrada rosca hembra BSPP	Salida : 1 enchufe	Referencia	Emba.
	G 1/2	ISG 11	ISG 111103WK	1

Aplique mural rosca hembra - 1 enchufe y purga -
Perfil ISO 6150 C - Paso 8 mm

T1

	Entrada rosca hembra BSPP	Salida : 1 enchufe	Referencia	Emba.
	G 1/2	CSI 08	CSI 081103WK	1

APLIQUES MURALES SIMPLES

Aplique mural rosca hembra - Salida 1 enchufe y purga T4

NUEVO	Entrada rosca hembra BSPP	Salida rosca hembra BSPP	Referencia	Emba.
	G 1/2	G 1/2	MF 103S1	1

Aplique mural rosca hembra - Salida 2 enchufes y purga T4

NUEVO	Entrada rosca hembra BSPP	Salida rosca hembra BSPP	Referencia	Emba.
	G 1/2	G 1/2	MF 103S2	1
	G 3/4	G 1/2	MF 104S2	1

PLETINAS EQUIPADOS PARA VIGAS HEA (IPN)

Pletina modelo grande para enrolladores DMO - DGO - DVO - DGF - DSF - DPF - DRF - DMF T2

	Composición	Compatibilidad	Peso (máx. kg)	Referencia	Emba.
	- 1 pletina PLA 2000N - 4 garras de fijación - 2 kits de tornillos - 1 tope de caucho	Pletina para fijación de los enrolladores : DMO-DGO-DVO-DGF-DSF-DPF-DRF-DMF	100	PLA 2000	1

Pletina modelo pequeño para enrolladores DSF - DPF - DRF - DMF T2

	Composición	Compatibilidad	Peso (máx. kg)	Referencia	Emba.
	- 1 pletina PLA 450N - 2 garras - 1 kit de tornillos y tuercas - 1 larguero de 420 mm	Pletina para fijación de los enrolladores: DSF - DMF - DRF - DPF	40	PLA 450	1

Pletina modelo grande para apliques prevoS1, conjuntos de tratamiento de aire ALTO, accesorios T2

	Composición	Compatibilidad	Peso (máx. kg)	Referencia	Emba.
	- 1 pletina PLA 1000N - 4 garras de fijación - 1 kit de tornillos y tuercas	Pletina para fijación : - Apliques prevoS1 - Soporte universal - Conjunto de tratamiento de aire ALTO	100	PLA 1000	1

Pletina modelo pequeño para apliques prevoS1, conjuntos de tratamiento de aire ALTO, accesorios T2

	Composición	Compatibilidad	Peso (máx. kg)	Referencia	Emba.
	- 1 pletina PLA 225N - 2 garras - 1 larguero de 40 mm - 1 kit de tornillos y tuercas	Pletina para fijación : - Apliques Prevo S1 - Conjunto de tratamiento de aire ALTO - Soporte universal	40	PLA 225	1

PRODUCTOS ASOCIADOS



Enrolladores para aire comprimido- p 108



Grupos de tratamiento del aire **ALTO** - p 160

PLETINAS SIMPLES PARA FIJACIÓN MURAL

Pletina simple modelo grande para enrolladores DMO - DGO - DVO - DGF - DSF - DPF - DRF - DMF

T2

Dénominación	Peso (máx. kg)	Referencia	Emba.
Pletina para fijación de los enrolladores : DMO-DGO-DVO-DGF-DSF-DPF-DRF-DMF	100	PLA 2000N	1

Pletina simple para enrolladores DSF - DPF - DRF - DMF

T2

Dénominación	Peso (máx. kg)	Referencia	Emba.
Pletina modelo pequeño para fijación de los enrolladores DSF - DPF - DRF - DMF	40	PLA 450N	1

Pletina simple modelo grande para apliques prevoS1, conjuntos de tratamiento de aire ALTO, accesorios

T2

Dénominación	Peso (máx. kg)	Referencia	Emba.
Pletina para fijación : - Apliques prevoS1 - Accesorios - Conjunto de tratamiento de aire	100	PLA 1000N	1

Pletina simple modelo pequeño para apliques prevoS1, conjuntos de tratamiento de aire ALTO, accesorios

T2

Dénominación	Peso (máx. kg)	Referencia	Emba.
Pletina para fijación - Apliques prevoS1 - Soporte universal - Conjunto de tratamiento de aire	40	PLA 225N	1

ACCESORIOS PARA PLETINAS

Soporte universal para accesorios

T2

Dénominación	Referencia	Emba.
Soporte universal para : - soporte para tubos flexibles - caja para tuercas - porta-herramientas	PLA FIX	1

Soporte para tubos

T2

Composición	Referencia	Emba.
Soporte para tubos con : - 1 gancho para pistola de soplado - 1 kit de tornillos y tuercas - 2 tapones de relleno en caucho	PLA HR	1
Soporte para tubos con : - 1 kit de iman	PLA HRM	1

Caja para tuercas

T2

Composición	Referencia	Emba.
Caja para tuercas compuesta por : - 1 soporte - 1 caja para tuercas - 1 kit de tornillos y tuercas	PLA BB	1
Caja para tuercas compuesta por : - 1 soporte - 1 caja para tuercas - 1 kit de iman	PLA BBM	1

Porta-herramientas

T2

Composición	Referencia	Emba.
Porta-herramientas : - 1 escuadra de fijación - 1 caja porta-herramientas - 1 kit de tornillos y tuercas	PLA TH	1

Gancho de suspensión

T2

Composición	Referencia	Emba.
Gancho de fijación se entrega con tornillos y tuercas M6 x 14 mm y tuercas estándar M6	PLA K	1

PIEZAS SUeltas PARA PLETINAS

Garra de fijación en viga HEA

T2

Composición	Referencia	Emba.
 Sistema de fijación compuesto de - 1 garra para fijación - 1 tornillo de cabeza rectangular M10 x 50 mm - 1 tuerca M10	PLA CR	1

Kit de tornillos y tuercas para fijación en pletinas

T2

Composición	Referencia	Emba.
 Kit de : - 4 tornillos M10 x 20 mm - 2 tuercas M10 - 2 tuercas prisioneras M10	PLA VEGM	1
Kit de : - 2 tornillos M8 x 20 mm - 1 tuerca M8 - 1 tuerca prisionera M8	PLA VEPM	1
Kit de : - 12 tornillos M6 x 20 - 12 tuercas M6 para fijación de un accesorio, de un aplique y de un conjunto ALTO	PLA VEAF	1
Kit de : - 4 tornillos M6 x 20 mm - 4 tuercas M6	PLA VEWF	1

Larguero para fijación de las pletinas modelos pequeños en vigas HEA

T2

Dénominación	Función	Referencia	Emba.
 Larguero de 420mm	Fijación de las pletinas PLA 450 y PLA 225 en la viga HEA	PLA RA	1

Tope de retención

T2

Composición	Referencia	Emba.
 Tope de caucho Ø 25 mm se entrega con - 1 tornillo M4 x 25 mm - 1 tuerca estándar M4	PLA TC	1

Gancho para soporte de tubos

T2

Dénominación	Referencia	Emba.
 Gancho de suspensión para fijación en el soporte para tubos	PLA HRK	1

CONCEPTO AMPS REDES EN PERFIL DE ALUMINIO PARA AIRE COMPRIMIDO

AMPS PRO - Barra de perfil de aluminio para aire comprimido

T4

Tubo Ø int. (mm)	Long. (m)	Referencia	Emba.
25	6	AMPS PRO25L6	6
38	6	AMPS PRO38L6	6
50	6	AMPS PRO50L6	6
75	6	AMPS PRO75L6	6
100	6	AMPS PRO100L6	6

Precio por metro

AMPS LK - Kit de unión

T4

Para 2 tubos Ø int. (mm)	Nº de bridas	Referencia	Emba.
25	2	AMPS LK25	1
38	2	AMPS LK38	1
50	4	AMPS LK50	1
75	2	AMPS LK75	1
100	2	AMPS LK100	1

AMPS L - Codo

T4

Para 2 tubos Ø int. (mm)	Referencia	Emba.
25	AMPS L25	1
38	AMPS L38	1
50	AMPS L50	1
75	AMPS L75	1
100	AMPS L100	1

AMPS LP - Codo con tapón

T4

Rosca hembra BSPP	Para 2 tubos Ø int. (mm)	Referencia	Emba.
G 3/4	25	AMPS LP25	1
G 1 1/4	38	AMPS LP38	1
G 1 1/2	50	AMPS LP50	1
G 2 1/2	75	AMPS LP75	1
G 3 1/2	100	AMPS LP100	1

AMPS T - Te

T4

Para 3 tubos Ø int. (mm)	Referencia	Emba.
25	AMPS T25	1
38	AMPS T38	1
50	AMPS T50	1
75	AMPS T75	1
100	AMPS T100	1

CONCEPTO AMPS REDES EN PERFIL DE ALUMINIO PARA AIRE COMPRIMIDO

AMPS B - Bloque de 5 vías

T4

Rosca hembra BSPP	Para tubo Ø int. (mm)	Referencia	Emba.
G 3/4	25	AMPS B2534	1
G 1 1/4	38	AMPS B38114	1
G 1 1/2	50	AMPS B50112	1
G 2 1/2	75	AMPS B75212	1

AMPS MS - Enchufe recto macho

T4

Rosca macho BSPP	Para tubo Ø int. (mm)	Referencia	Emba.
G 1/2	25	AMPS MS2512	1
G 3/4	25	AMPS MS2534	1
G 1 1/4	38	AMPS MS38114	1
G 1 1/2	50	AMPS MS50112	1
G 2 1/2	75	AMPS MS75212	1
G 3	100	AMPS MS1003	1
G 3 1/2	100	AMPS MS100312	1

AMPS FS - Enchufe recto hembra

T4

Rosca hembra BSPP	Para tubo Ø int. (mm)	Referencia	Emba.
G 3/8	25	AMPS FS2538	1
G 1/2	25	AMPS FS2512	1
G 1/2	38	AMPS FS3812	1
G 3/4	38	AMPS FS3834	1
G 1/2	50	AMPS FS5012	1
G 3/4	50	AMPS FS5034	1
G 1	50	AMPS FS501	1
G 1 1/2	75	AMPS FS75112	1
G 2 1/2	75	AMPS FS75212	1
G 2 1/2	100	AMPS FS100212	1
G 3	100	AMPS FS1003	1

AMPS P - Tapón macho

T4

Rosca macho BSPP	Referencia	Emba.
G 3/4	AMPS P2534	1
G 1 1/4	AMPS P38114	1
G 1 1/2	AMPS P50112	1
G 2 1/2	AMPS P75212	1
G 3 1/2	AMPS P100312	1

CONCEPTO AMPS REDES EN PERFIL DE ALUMINIO PARA AIRE COMPRIMIDO

AMPS EP - Tapón de extremo

T4

Para tubo Ø int. (mm)	Referencia	Emba.
25	AMPS EP25	1
38	AMPS EP38	1
50	AMPS EP50	1
75	AMPS EP75	1
100	AMPS EP100	1

AMPS R - Reducción macho/hembra

T4

Rosca macho BSPP	Rosca hembra BSPP	Referencia	Emba.
G 1 1/4	G 3/4	AMPS R11434	1
G 1 1/2	G 1 1/4	AMPS R112114	1
G 2 1/2	G 1 1/2	AMPS R212112	1
G 3 1/2	G 1 1/2	AMPS R312112	1
G 3 1/2	G 2 1/2	AMPS R312212	1
G 3 1/2	G 3	AMPS R3123	1

AMPS VB - Rótula orientable de 80° a 180°

T4

Para 2 tubos Ø int. (mm)	Referencia	Emba.
25	AMPS VB25	1
38	AMPS VB38	1
50	AMPS VB50	1
75	AMPS VB75	1

AMPS DK - Kit de dilatación

T4

Para tubo Ø int.	Referencia	Emba.
25	AMPS DK25	1
38	AMPS DK38	1
50	AMPS DK50	1

CONCEPTO AMPS REDES EN PERFIL DE ALUMINIO PARA AIRE COMPRIMIDO

AMPS HP - Placa de retención

T4

Para tubo Ø int. (mm)	Nº de bridas	Referencia	Emba.
25	2 x M6 x 12	AMPS HP25	1
38	2 x M6 x 12	AMPS HP38	1
50	3 x M6 x 12	AMPS HP50	1
75	4 x M6 x 12	AMPS HP75	1
100	4 x M6 x 12	AMPS HP100	1

CONCEPTO AMPS PIEZAS DE EMPALME PARE REDES AMPS DE AIRE COMPRIMIDO

AMPS WB - Soporte mural con clips

T4

Para tubo Ø int. (mm)	Profundidad (mm)	Referencia	Emba.
25 a 75	20	AMPS WB20	1
25 a 75	50	AMPS WB50	1

AMPS CP - Placa de conexión

T4

Rosca hembra BSPP	Para tubo Ø int. (mm)	Referencia	Emba.
G 1/8	25 a 75	AMPS CP318	1
G 1/4	25 a 75	AMPS CP314	1

AMPS WB - Escuadra

T4

Para tubo Ø int. (mm)	Profundidad (mm)	Referencia	Emba.
25 a 75	60	AMPS WB60	1

AMPS CP - Placa de conexión

T4

Rosca hembra BSPP	Para tubo Ø int. (mm)	Referencia	Emba.
G 3/8	25 a 75	AMPS CP38	1
G 1/2	25 a 75	AMPS CP12	1
G 3/4	25 a 75	AMPS CP34	1
G 1	25 a 75	AMPS CP1	1

AMPS WB - Soporte de fijación de techo

T4

Para tubo Ø int. (mm)	Para varilla roscada (mm)	Referencia	Emba.
25 a 75	M8	AMPS WB80	1
100	M10	AMPS WB100	1

AMPS CP - Placa de conexión

T4

Rosca hembra BSPP	Para tubo Ø int. (mm)	Referencia	Emba.
G 1/2	75	AMPS CP7512	1
G 3/4	75	AMPS CP7534	1
G 1 1/4	75	AMPS CP75114	1
G 1 1/2	75	AMPS CP75112	1
G 2	75	AMPS CP752	1

AMPS LF1 - Brida de unión para kits de unión

T4

Para tubo Ø int. (mm)	Referencia	Emba.
25 a 50	AMPS LF1	1
75 a 100	AMPS LF2	1

AMPS CP - Placa de conexión

T4

Rosca hembra BSPP	Para tubo Ø int. (mm)	Referencia	Emba.
G 1/2	100	AMPS CP10012	1
G 3/4	100	AMPS CP10034	1
G 1 1/4	100	AMPS CP100114	1
G 1 1/2	100	AMPS CP100112	1
G 2	100	AMPS CP1002	1

AMPS N - Tuerca

T4

Rosca métrica (mm)	Para tubo Ø int. (mm)	Referencia	Emba.
M6	25 a 50	AMPS N1	10
M6	75	AMPS N2	10
M6	100	AMPS N3	10

CONCEPTO AMPS PIEZAS DE EMPALME PARE REDES AMPS DE AIRE COMPRIMIDO

AMPS S - Tornillo

T4

	Rosca métrica (mm)	Para tubo Ø int. (mm)	Referencia	Emba.
	M6 x 8	25 a 50	AMPS S1	10
	M6 x 12	75	AMPS S2	10
	M6 x 16	100	AMPS S3	10

AMPS SK - Kit tornillo + tuerca con muelle

T4

	Rosca métrica (mm)	Para tubo Ø int. (mm)	Referencia	Emba.
	M6 x 12	25 a 50	AMPS SK2	10
	M6 x 16	75	AMPS SK3	10
	M6 x 16	100	AMPS SK4	1

AMPS SN - Tornillo + tuerca

T4

	Rosca métrica (mm)	Para tubo Ø int. (mm)	Referencia	Emba.
	M6 x 8	25 a 50	AMPS SN1	10
	M6 x 12	25 a 50	AMPS SN2	10
	M6 x 16	75	AMPS SN3	10
	M6 x 16	100	AMPS SN4	1

AMPS D - Herramienta de perforación

T4

	Rosca (de la placa de conexión correspondiente)	Referencia	Emba.
	G 3/8	AMPS D38	1
	G 1/2	AMPS D12	1
	G 3/4	AMPS D34	1

AMPS DS - Broca para herramienta de perforación

T4

	Rosca (de la placa de conexión correspondiente)	Referencia	Emba.
	G 3/8	AMPS DS38	1
	G 1/2	AMPS DS12	1
	G 3/4	AMPS DS34	1

CONCEPTO AMPS PIEZAS DE EMPALME PARE REDES AMPS DE AIRE COMPRIMIDO

AMPS W - Llave de apriete

T4

	Para racor para tubo Ø int. (mm)	Cota en plano	Referencia	Emba.
	38	44	AMPS W44	1
	50	55	AMPS W55	1
	75	80	AMPS W80	1
	100	106	AMPS W106	1

AMPS CLE - Llave hexagonal

T4

	Tamaño (mm)	Referencia	Emba.
	5	AMPS CLE5	1

PPS CHE - Herramienta para desbarbado

T4

	Función	Referencia	Emba.
	Desbarbado interior/ exterior	PPS CHERAP	1

AMPS G - Gel de lubricado

T4

	Capacidad (ml)	Referencia	Emba.
	50	AMPS G50	1

AMPS OR - Junta tórica

T4

	Para racor para tubo Ø int. (mm)	Referencia	Emba.
	25	AMPS OR25	10
	38	AMPS OR38	10
	50	AMPS OR50	10
	75	AMPS OR75	10
	100	AMPS OR100	10

SISTEMA PVR REDES TODO PVC

Tubo rígido de PVC

T4

	Ø ext. (mm)	Long.	Referencia	Emba.
	20	4	PVR TU20	4
	25	4	PVR TU25	4
	32	4	PVR TU32	4
	40	4	PVR TU40	4
	50	4	PVR TU50	4
	63	4	PVR TU63	4
	Referencia gestionada en metros			

Precio por metro

ENCHUFES PVR PARA PEGAR

PVR UNI - Unión simple

T4

	Para tubo Ø ext. (mm)	Referencia	Emba.
	20	PVR UNI20	1
	25	PVR UNI25	1
	32	PVR UNI32	1
	40	PVR UNI40	1
	50	PVR UNI50	1
	63	PVR UNI63	1

PVR BTP - Brida de derivación para tubo

T4

NUEVO	Canalización primaria Ø ext. (mm)	Bajada Ø ext. tubo (mm)	Referencia	Emba.
	25	20	PVR BTP2520	1
	32	20	PVR BTP3220	1
	40	20	PVR BTP4020	1
	40	25	PVR BTP4025	1
	50	20	PVR BTP5020	1
	50	25	PVR BTP5025	1
	63	20	PVR BTP6320	1
	63	25	PVR BTP6325	1
	63	32	PVR BTP6332	1

PVR 4CE - Codo igual 45° hembra

T4

	Para tubo Ø ext. (mm)	Referencia	Emba.
	20	PVR 4CE20	1
	25	PVR 4CE25	1
	32	PVR 4CE32	1
	40	PVR 4CE40	1
	50	PVR 4CE50	1
	63	PVR 4CE63	1

PPS1 BT - Brida de derivación rosca hembra cilíndrica para tubo

T4

NUEVO	Para tubo Ø ext. (mm)	Rosca hembra BSPP	Referencia	Emba.
	25	G 3/8	PPS1 BT2517	1
	25	G 1/2	PPS1 BT2512	1
	32	G 1/2	PPS1 BT3212	1
	32	G 3/4	PPS1 BT3227	1
	40	G 1/2	PPS1 BT4012	1
	40	G 3/4	PPS1 BT4027	1
	40	G 1	PPS1 BT4034	1
	50	G 1/2	PPS1 BT5012	1
	50	G 3/4	PPS1 BT5027	1
	50	G 1	PPS1 BT5034	1
	63	G 1/2	PPS1 BT6312	1
	63	G 3/4	PPS1 BT6327	1
	63	G 1	PPS1 BT6334	1

PVR 9CE - Codo igual 90° hembra

T4

	Para tubo Ø ext. (mm)	Referencia	Emba.
	20	PVR 9CE20	1
	25	PVR 9CE25	1
	32	PVR 9CE32	1
	40	PVR 9CE40	1
	50	PVR 9CE50	1
	63	PVR 9CE63	1

PVR BOU - Tapón hembra

T4

	Para tubo Ø ext. (mm)	Referencia	Emba.
	20	PVR BOU20	1
	25	PVR BOU25	1
	32	PVR BOU32	1
	40	PVR BOU40	1
	50	PVR BOU50	1
	63	PVR BOU63	1

ENCHUFES PVR PARA PEGAR

PVR TEE - Te igual hembra

T4

Para tubo Ø ext. (mm)	Referencia	Emba.
20	PVR TEE20	1
25	PVR TEE25	1
32	PVR TEE32	1
40	PVR TEE40	1
50	PVR TEE50	1
63	PVR TEE63	1

ENCHUFES PVR PARA PEGAR

PVR RMT - Enchufe recto hembra

T4

Para enchufe Ø int. (mm)	Rosca hembra BSPP	Referencia	Emba.
20	G 1/2	PVR RMT2012	1
25	G 3/4	PVR RMT2527	1

PVR TER - T reducida hembra hembra hembra

T4

Para tubo Ø ext. (mm)	Para tubo Ø ext. (mm)	Referencia	Emba.
25	20	PVR TER2520	1
32	20	PVR TER3220	1
32	25	PVR TER3225	1
40	20	PVR TER4020	1
40	25	PVR TER4025	1
50	20	PVR TER5020	1
50	25	PVR TER5025	1
63	20	PVR TER6320	1
63	25	PVR TER6325	1

PVR 9CT - Codo 90° hembra taladrada

T4

Para tubo Ø ext. (mm)	Rosca hembra BSPP	Referencia	Emba.
20	G 1/2	PVR 9CT2012	1
25	G 3/4	PVR 9CT2527	1

PVR RFT - Conexión recta hembra taladrada

T4

Para tubo Ø ext. (mm)	Rosca hembra BSPP	Referencia	Emba.
20	G 1/2	PVR RFT2012	1
25	G 3/4	PVR RFT2527	1
32	G 1	PVR RFT3234	1

PVR TET - T hembra / hembra taladrada

T4

Para tubo Ø ext. (mm)	Rosca hembra BSPP	Referencia	Emba.
20	G 1/2	PVR TET2012	1
25	G 3/4	PVR TET2527	1
32	G 1	PVR TET3234	1

PVR RFM - Conexión roscada recta para enchufe a pegar

T4

Para enchufe Ø int. (mm)	Para tubo Ø ext. (mm)	Rosca macho BSPP	Referencia	Emba.
20	16	G 1/2	PVR RFM162012	1
25	20	G 1/2	PVR RFM202512	1
32	25	G 3/4	PVR RFM253227	1
40	32	G 1	PVR RFM324034	1
50	40	G 1	PVR RFM405042	1
63	50	G 1 1/4	PVR RFM506349	1
75	63	G 2	PVR RFM637560	1

PVR 3UL - Unión 3 piezas latón hembra taladrada

T4

Para tubo Ø ext. (mm)	Rosca hembra BSPP	Referencia	Emba.
20	G 1/2	PVR 3UL2012	1
25	G 3/4	PVR 3UL2527	1
32	G 1	PVR 3UL3234	1
40	G 1 1/4	PVR 3UL4042	1
50	G 1 1/2	PVR 3UL5049	1
63	G 2	PVR 3UL6360	1

ENCHUFES PVR PARA PEGAR

PVR 3UN - Unión 3 piezas hembra / hembra

T4

Para tubo Ø ext. (mm)	Referencia	Emba.
20	PVR 3UN20	1
25	PVR 3UN25	1
32	PVR 3UN32	1
40	PVR 3UN40	1
50	PVR 3UN50	1
63	PVR 3UN63	1



PVR RDS - Reducción simple

T4

Ø ext. (mm)	Ø int. (mm)	Referencia	Emba.
25	20	PVR RDS2520	1
32	25	PVR RDS3225	1
40	32	PVR RDS4032	1
50	40	PVR RDS5040	1
63	50	PVR RDS6350	1



PVR RDD - Reducción doble

T4

Para enchufe Ø int. (mm)	Para tubo Ø ext. (mm)	Referencia	Emba.
32	20	PVR RDD3220	1
40	25	PVR RDD4025	1
50	32	PVR RDD5032	1
63	40	PVR RDD6340	1

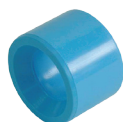

PRODUCTOS ASOCIADOS



Pletinas equipados para vigas **IPN / HEA** - p 96



Purgas eléctricas y mecánicas - p 184

ACCESORIOS PARA MONTAJE PARA REDES PVR

PPS1 CI - Abrazaderas de fijación (unidad de venta = 1 caja de 5 orejas)

T4

Para tubo Ø ext. (mm)	Referencia	Emba.
16	PPS1 CI16	5
20	PPS1 CI20	5
25	PPS1 CI25	5
32	PPS1 CI32	5
40	PPS1 CI40	5
50	PPS1 CI50	5
63	PPS1 CI63	5



Consola metálica de soporte

T4

Dénominación	Referencia	Emba.
Long. 180 mm	CS 180L	1
Long. 300 mm	CS 310L	1
Long. 420 mm	CS 420L	1
Long. 510 mm	CS 500	1
Tornillo de fijación M8 (3) para consola CS 500	CS VIS	1
Tornillo de fijación (4) para CS 180L - CS 310L - CS 420L	CS VIS2	1

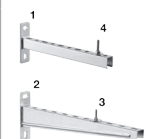

Clips de fijación taladrados M8

T4

Espesor del tabique (mm)	Rosca métrica	Referencia	Emba.
3 a 8 (1)		CP 38	1
8 a 14 (1)		CP 814	1
14 a 20 (1)		CP 1420	1
0 a 16 (2)	M6 o recto	CP 016	1

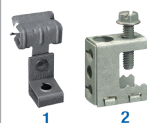

ACCESORIOS PARA MONTAJE PARA REDES PVR

Tornillo de estrella Ø 6 mm

T4

	Long. (mm)	Referencia	Emba.
	60	TVB 660	10
	90	TVB 690	10

Tornillo a tuerca M8

T4

	Long. (mm)	Referencia	Emba.
	60	TVM 860	10

Taco galvanizado rosca M8

T4

	Long. (mm)	Uso	Rosca métrica	Referencia	Emba.
	50	Para cualquier material de construcción	M8	PV 80	10
	80	Para cualquier material de construcción	M8	PV 880	10

Tira-fondo Ø 8 mm

T4

	Long. (mm)	Referencia	Emba.
	50	TTF 850	10
	80	TTF 880	10

Distanciador M8

T4

	Rosca métrica	Referencia	Emba.
	M8	TL M8	1

Varilla roscada M8

T4

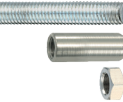
	Dénominación	Rosca métrica	Long. (m)	Referencia	Emba.
	Varilla roscada	M8	1	TF M8100	1
	Unión para esparrago M8	M8	-	TL RM8	1
	Tuerca	M8	-	TE M8	100

ACCESORIOS PARA MONTAJE PARA REDES PVR

Aplique mural rosca hembra - Salida 1 enchufe y purga

T4

NUEVO	Entrada rosca hembra BSPP	Salida rosca hembra BSPP	Referencia	Emba.
	G 1/2	G 1/2	MF 103S1	1

Aplique mural rosca hembra - Salida 2 enchufes y purga

T4

NUEVO	Entrada rosca hembra BSPP	Salida rosca hembra BSPP	Referencia	Emba.
	G 1/2	G 1/2	MF 103S2	1
	G 3/4	G 1/2	MF 104S2	1

PVR VFF - Válvula de manguito esférica roscada

T4

	Para tubo Ø ext. (mm)	Referencia	Emba.
	20	PVR VFF20	1
	25	PVR VFF25	1
	32	PVR VFF32	1
	40	PVR VFF40	1
	50	PVR VFF50	1
	63	PVR VFF63	1

ACCESORIOS PARA MONTAJE PARA REDES PVR

PVR DEC - Decapante para tubo PVR

T4

	Capacidad (ml)	Función	Referencia	Emba.
	500	Desengrasante / limpiador	PVR DEC500	1

PVR COL - Soldadura en frío para tubo PVR y su pincel

T4

	Capacidad (ml)	Referencia	Emba.
	250	PVR COL250	1
	500	PVR COL500	1
	1000	PVR COL1000	1
Cola para ensamblar enchufes / tubos con pincel integrado en el tapón.			



PVR KITM - Kit de ensamblaje para tubo PVR

T4

	Composición	Referencia	Emba.
	- 1 Herramienta para achaflanar tubos Ø ext : 20 a 50 mm - 1 Decapante 500 ml - 1 Cola y pincel 500 ml	PVR KITM	1



PVR CTU - Cortatubos

T4

	Dénominación	Para tubo Ø ext. (mm)	Referencia	Emba.
	1 Cortatubos para tubo PVR	20 a 40	PVR CTU40	1
	2 Cortatubos para tubo PVR	50 a 63	PVR CTU110	1

PPS/PVR CHE - Herramienta para achaflanar

T4

	Para tubo Ø ext. (mm)	Función	Referencia	Emba.
	20 a 110 (4)	-	PVR CHE110	1
	16 a 50 (2)	-	PPS CHE50P	1
	(3)	Desbarbado interior/ exterior	PPS CHERAP	1

VÁLVULAS DE SEGURIDAD CON ESCAPE RÁPIDO

Válvulas de seguridad con escape rápido

Válvulas conformes a la directiva 97/23/CE				
Rosca macho BSPP	Gamas de calibrado de 0,5 en 0,5 bar	Referencia		Cond.
G 1/4	0,5 a 12	A23 14T...		1
G 1/4	12,5 a 20	A23 14T...		1
G 1/4	20,5 a 30	A23 14T...		1
G 3/8	0,5 a 12	A23 38T...		1
G 3/8	12,5 a 20	A23 38T...		1
G 3/8	20,5 a 30	A23 38T...		1
G 1/2	0,5 a 12	A23 12T...		1
G 1/2	12,5 a 20	A23 12T...		1
G 1/2	20,5 a 30	A23 12T...		1
G 3/4	0,5 a 12	A23 34T...		1
G 3/4	12,5 a 20	A23 34T...		1
G 3/4	20,5 a 30	A23 34T...		1
G 1	0,5 a 12	A23 01T...		1
G 1	12,5 a 20	A23 01T...		1
G 1	20,5 a 30	A23 01T...		1



En el pedido:
Especifique imperativamente para cada válvula encargada su referencia y la presión de disparo deseada

Elección:
La elección de la válvula depende del caudal del compresor. El caudal de la válvula debe ser superior o igual al caudal del compresor.

Presión de escape:
La presión inicial de apertura de la válvula es igual a la presión de disparo. La válvula está a pleno caudal a una presión de apertura de +10%. La presión de cierre es igual a la presión de disparo - 10%.

Instalación:
En posición vertical, lo más cerca posible de la capacidad a proteger y comprobando que en caso de escape la descarga a la atmósfera no presenta ningún peligro.

Ejemplo :
Válvula : G 1/4
Presión : 6,5 bar
Referencia : A23 14T6,5

Ejemplo de caudal (Nm³/h) función de la presión (bar)

	G 1/4	G 3/8	G 1/2	G 3/4	G 1
Ref.	A23 14T	A23 38T	A23 12T	A23 34T	A23 01T
Presión					
3	88	177	214	30	610
6	155	313	379	530	1079
7	178	358	434	607	1235
8	200	404	489	694	1392
9	223	449	544	761	1548
10	146	495	599	838	1708
12	392	586	708	991	2022
15	360	724	873	1222	2497
16	382	770	928	1299	2654
20		955	1148	1606	3291
25		1183	1422	1990	
30		1411	1697	2374	

Enrolladores, tubos y abrazaderas



Enrolladores	108 - 114
Tubos de poliamida y de poliuretano	114 - 117
Tubos en rollo	118 - 119
Prolongadores de tubo con enchufes	120 - 122
Tubos en espiral	123 - 125
Abrazaderas de orejas y de tornillo	126 - 130
Protectores	130
Equilibradores y brazos de suspensión BAL	131

ENROLLADORES PARA AIRE COMPRIMIDO CON TAMBOR CERRADO / ACERO

Serie DSF - Modelo pequeño - Tubo poliuretano con base poliéster

T2

Ø int./ext. (mm)	Long. (m)	Enchufe	Referencia	Emba.
8 x 11	5	ISI 06	DSF 0805IS	1
10 x 14	3	ISI 06	DSF 1003IS	1
8 x 11	5	ESI 07	DSF 0805ES	1
10 x 14	3	ESI 07	DSF 1003ES	1
8 x 11	5	CSI 06	DSF 0805CS	1
10 x 14	3	CSI 06	DSF 1003CS	1

Soporte orientable 180°
Entrada : 1 m de tubo
Presión : 12 bar
Temperatura : -15° C a +40° C



ENROLLADORES PARA AIRE COMPRIMIDO CON TAMBOR CERRADO / ACERO

Serie DRFB - Enrollador con retorno controlado del tubo - Tubo PU/PVC

T2

Ø int./ext. (mm)	Long. (m)	Enchufe	Referencia	Emba.
8 x 12	12	ISI 06	DRFB 0812IS	1
8 x 12	15	ISI 06	DRFB 0815IS	1
10 x 14	10	ISI 06	DRFB 1010IS	1
10 x 14	12	ISI 06	DRFB 1012IS	1
8 x 12	12	ESI 07	DRFB 0812ES	1
8 x 12	15	ESI 07	DRFB 0815ES	1
10 x 14	10	ESI 07	DRFB 1010ES	1
10 x 14	12	ESI 07	DRFB 1012ES	1
8 x 12	12	CSI 06	DRFB 0812CS	1
8 x 12	15	CSI 06	DRFB 0815CS	1
10 x 14	10	CSI 06	DRFB 1010CS	1
10 x 14	12	CSI 06	DRFB 1012CS	1

Soporte orientable 180°
Entrada : 1 m de tubo
Presión : 12 bar
Temperatura : -15° C a +65° C



SEGURIDAD

Serie DMF - Modelo industrial - Tubo poliuretano

T2

Ø int./ext. (mm)	Long. (m)	Enchufe	Referencia	Emba.
8 x 12	10	ISI 06	DMF 0810IS	1
8 x 12	10	ESI 07	DMF 0810ES	1
8 x 12	10	CSI 06	DMF 0810CS	1

Soporte orientable 180°
Entrada : G 3/8 H + 1 m de tubo
Presión : 12 bar
Temperatura : -15° C a +40° C



Serie DPF - Modelo Industrial - Tubo poliuretano

T2

Ø int./ext. (mm)	Long. (m)	Enchufe	Referencia	Emba.
8 x 12	12	ISI 06	DPF 0812IS	1
10 x 14	10	ISI 06	DPF 1010IS	1
8 x 12	12	ESI 07	DPF 0812ES	1
10 x 14	10	ESI 07	DPF 1010ES	1
8 x 12	12	CSI 06	DPF 0812CS	1
10 x 14	10	CSI 06	DPF 1010CS	1

Soporte orientable 180°
Entrada : G 3/8 H + 1 m de tubo
Presión : 12 bar
Temperatura : -15° C a +40° C



Serie DRF - Modelo Eco - Tubo Ext : PU/PVC, Int. PU con base poliéster

T2

Ø int./ext. (mm)	Long. (m)	Enchufe	Referencia	Emba.
8 x 12	12	ISI 06	DRF 0812IS	1
8 x 12	15	ISI 06	DRF 0815IS	1
10 x 14	10	ISI 06	DRF 1010IS	1
10 x 14	12	ISI 06	DRF 1012IS	1
10 x 14	15	ISI 06	DRF 1015IS	1
8 x 12	12	ESI 07	DRF 0812ES	1
8 x 12	15	ESI 07	DRF 0815ES	1
10 x 14	10	ESI 07	DRF 1010ES	1
10 x 14	12	ESI 07	DRF 1012ES	1
10 x 14	15	ESI 07	DRF 1015ES	1
8 x 12	12	CSI 06	DRF 0812CS	1
8 x 12	15	CSI 06	DRF 0815CS	1
10 x 14	10	CSI 06	DRF 1010CS	1

Soporte orientable 180°
Entrada : 1 m de tubo
Presión : 12 bar
Temperatura : -15° C a +65° C



Serie DGF - Grande Modelo Industrial - Tubo caucho

T2

Ø int./ext. (mm)	Long. (m)	Enchufe	Referencia	Emba.
8 x 14	10	ISI 06	DGF 0810IS	1
8 x 14	15	ISI 06	DGF 0815IS	1
8 x 14	20	ISI 06	DGF 0820IS	1
10 x 17	10	ISI 06	DGF 1010IS	1
10 x 17	15	ISI 06	DGF 1015IS	1
13 x 20	10	ISI 08	DGF 1310IS	1
8 x 14	10	ESI 07	DGF 0810ES	1
8 x 14	15	ESI 07	DGF 0815ES	1
8 x 14	20	ESI 07	DGF 0820ES	1
10 x 17	10	ESI 07	DGF 1010ES	1
10 x 17	15	ESI 07	DGF 1015ES	1
13 x 20	10	ESI 07	DGF 1310ES	1
8 x 14	10	CSI 06	DGF 0810CS	1
8 x 14	15	CSI 06	DGF 0815CS	1
8 x 14	20	CSI 06	DGF 0820CS	1
10 x 17	10	CSI 06	DGF 1010CS	1
10 x 17	15	CSI 06	DGF 1015CS	1
13 x 20	10	CSI 08	DGF 1310CS	1

Soporte fijo
Entrada : G 3/8 H
Entrada : G 1/2 M para el modelo DGF 1310
Presión máx : 12 bar
Temperatura : -15° C a +40° C



ENROLLADORES PARA AIRE COMPRIMIDO CON TAMBOR CERRADO / ACERO INOX

Serie DSF/I - Modelo acero inox 304 - Tubo de poliuretano trenzado

T2

Ø int./ext. (mm)	Long. (m)	Enchufe	Referencia	Emba.
8 x 12	5	ESI 07HE	DSFI 0805ESHE	1
Soporte orientable 180° Entrada : 1 m de tubo Presión máx : 12 bar Temperatura : -15° C a +70° C				



Serie DRF - Modelo acero inox 304 - Tubo de poliuretano con base ether

T2

Ø int./ext. (mm)	Long. (m)	Enchufe	Referencia	Emba.
10 x 14	12	ESI 07HE	DRFI 1012ESHE	1
Soporte orientable 180° Presión máx : 12 bar Entrada : 1 m de tubo Temperatura : -15° C a +65° C entrada fija				



Serie DRFB/I - Enrollador con retorno controlado del tubo - Modelo acero inox 304 - Tubo PU/PVC

T2

Ø int./ext. (mm)	Long. (m)	Enchufe	Referencia	Emba.
10 x 14	12	ESI 07HE	DRFINB 1012ESHE	1
Soporte orientable 180° Entrada : 1 m de tubo Presión : 12 bar Temperatura : -15° C a +65° C entrada fija				



SEGURIDAD

ENROLLADORES PARA AIRE COMPRIMIDO CON TAMBOR CERRADO / ACERO

Serie DMO - Modelo mediano - Tubo caucho

T2

Ø int./ext. (mm)	Long. (m)	Enchufe	Referencia	Emba.
8 x 14	10	ISI 06	DMO 0810IS	1
8 x 14	15	ISI 06	DMO 0815IS	1
8 x 14	20	ISI 06	DMO 0820IS	1
10 x 17	10	ISI 06	DMO 1010IS	1
10 x 17	15	ISI 06	DMO 1015IS	1
10 x 17	20	ISI 06	DMO 1020IS	1
13 x 20	15	ISI 08	DMO 1315IS	1
8 x 14	10	ESI 07	DMO 0810ES	1
8 x 14	15	ESI 07	DMO 0815ES	1
8 x 14	20	ESI 07	DMO 0820ES	1
10 x 17	10	ESI 07	DMO 1010ES	1
10 x 17	15	ESI 07	DMO 1015ES	1
10 x 17	20	ESI 07	DMO 1020ES	1
13 x 20	15	ESI 07	DMO 1315ES	1
8 x 14	10	CSI 06	DMO 0810CS	1
8 x 14	15	CSI 06	DMO 0815CS	1
8 x 14	20	CSI 06	DMO 0820CS	1
10 x 17	10	CSI 06	DMO 1010CS	1
10 x 17	15	CSI 06	DMO 1015CS	1
10 x 17	20	CSI 06	DMO 1020CS	1
13 x 20	15	CSI 08	DMO 1315CS	1
Soporte fijo Entrada : G 3/8 H Entrada : G 1/2 M para el modelo DMO 1315 + 1 m de tubo Presión : 12 bar Temperatura : -15° C a +40° C				



Serie DGO - Modelo grande - Tubo caucho

T2

Ø int./ext. (mm)	Long. (m)	Enchufe	Referencia	Emba.
10 x 17	25	ISI 06	DGO 1025IS	1
13 x 20	20	ISI 08	DGO 1320IS	1
16 x 23	10	ISI 11	DGO 1610IS	1
16 x 23	10	ISG 11	DGO 1610	1
10 x 17	25	ESI 07	DGO 1025ES	1
16 x 23	10	ESI 11	DGO 1610ES	1
13 x 20	20	ESI 07	DGO 1320ES	1
10 x 17	25	CSI 06	DGO 1025CS	1
13 x 20	20	CSI 08	DGO 1320CS	1
16 x 23	10	CSM 11	DGO 1610CSM	1
Soporte fijo Entrada : G 3/8 H Entrada : G 1/2 M para el modelo DGO 1320 + DGO 1610 + 1 m de tubo Presión : 12 bar Temperatura : -15° C a +65° C				



ENROLLADORES PARA AIRE COMPRIMIDO CON TAMBOR CERRADO / ACERO

Serie DLO - Modelo extra grande - Tubo caucho

T2

Ø int./ext. (mm)	Long. (m)	Enchufe	Referencia	Emba.
13 x 20	30	ISI 11	DLO 1330IS	1
16 x 23	25	ISI 11	DLO 1625IS	1
19 x 27	20	ISI 11	DLO 1920IS	1
13 x 20	30	ESI 11	DLO 1330ES	1
16 x 23	25	ESI 11	DLO 1625ES	1
19 x 27	20	ESI 11	DLO 1920ES	1

 Soporte fijo
 Entrada : G 1/2 M
 Entrada : G 1 M para el modelo DLO 1920
 + 1 m de tubo
 Presión : 12 bar
 Temperatura : -15° C a +70° C

Serie DVO - Modelo mediano - Tubo de poliuretano trenzado

T2

Ø int./ext. (mm)	Long. (m)	Enchufe	Referencia	Emba.
10 x 14	25	ISI 06	DVO 1025IS	1
10 x 14	25	ESI 07	DVO 1025ES	1



 Soporte fijo
 Entrada : G 3/8 H
 + 1 m de tubo
 Presión : 12 bar
 Temperatura : -15° C a +40° C

ENROLLADOR CON TAMBOR ABIERTO

Serie DMP - Tubo poliuretano

T2

Ø int./ext. (mm)	Long. (m)	Enchufe	Referencia	Emba.
8 x 12	30	ISI 06	DMP 0830IS	1
10 x 14	25	ISI 06	DMP 1025IS	1
8 x 12	30	ESI 07	DMP 0830ES	1
10 x 14	25	ESI 07	DMP 1025ES	1



ENROLLADORES INDUSTRIALES PARA AIRE COMPRIMIDO SIN TUBO

Serie DMO - Sin tubo - Acero

T2

Entrada giratoria rosca hembra BSPP	Salida rosca macho BSPP	Referencia	Emba.
G 3/8	G 3/8	DMO N	1



 Presión : 15 bar

ENROLLADORES PARA AGUA CON TAMBOR CERRADO / ACERO

Serie DMO - DGO / Acero con tubo caucho - calidad alimentaria

T2

Ø int./ext. (mm)	Long. (m)	Enchufe	Referencia	Emba.
16 x 24	10	ELS 09	DMO 1610LS	1
16 x 24	15	ELS 09	DGO 1615LS	1

 Entrada : G 1/2 M
 + 1 m de tubo
 Presión máx : 10 bar
 Temperatura : -15° C a +60° C

Serie DLO / Acero con tubo caucho - calidad alimentaria

T2

Ø int./ext. (mm)	Long. (m)	Enchufe	Referencia	Emba.
16 x 24	25	ELS 09	DLO 1625LS	1
19 x 28	20	ELS 09	DLO 1920LS	1

 Soporte fijo
 Entrada : G 1/2 M para DLO 1625
 G 1 M para DLO 1920
 + 1 m de tubo
 Presión máx : 10 bar
 Temperatura : -15° C a +60° C

Serie DVO - Acero con tubo PVC

T2

Ø int./ext. (mm)	Long. (m)	Enchufe	Referencia	Emba.
12,7 x 17	20	ELS 09	DVO 1320LS	1
15 x 21	15	ELS 09	DVO 1515LS	1

 Soporte fijo
 Entrada : G 1/2 M
 + 1 m de tubo
 Presión máx : 10 bar
 Temperatura : -15° C a +60° C

ENROLLADORES PARA AGUA CON TAMBOR CERRADO / ACERO INOX

Serie DSF/I - Modelo acero inox 304 - Tubo de poliuretano trenzado con base ether

T2

Ø int./ext. (mm)	Long. (m)	Enchufe	Referencia	Emba.
8 x 12	5	ELS 09	DSFI 0805LS	1
 <p>Soporte orientable 180° Presión máx : 10 bar Entrada : 1 m de tubo Temperatura : -15° C a +40° C</p>				

Serie DRF - Modelo acero inox 304 - Tubo de poliuretano con base ether

T2

Ø int./ext. (mm)	Long. (m)	Enchufe	Referencia	Emba.
10 x 14	12	ELS 09	DRFI 1012LS	1
 <p>Soporte orientable 180° Presión máx : 10 bar Entrada : 1 m de tubo Temperatura : -15° C a +65° C</p>				

ENROLLADORES PARA AGUA CON TAMBOR ABIERTO/ ACERO INOX

Serie DMOI - DGOI / Acero inox 304 con tubo caucho - calidad alimentaria

T2

Ø int./ext. (mm)	Long. (m)	Enchufe	Referencia	Emba.
16 x 24	10	ELS 09	DMOI 1610LS	1
16 x 24	15	ELS 09	DGOI 1615LS	1
 <p>Soporte fijo Entrada : G 1/2 M + 1 m de tubo Presión máx : 10 bar Temperatura : -15° C a +60° C</p>				

Serie DLOI / Acero inox 304 con tubo caucho - calidad alimentaria

T2

Ø int./ext. (mm)	Long. (m)	Entrada giratoria rosca macho BSPP	Referencia	Emba.
16 x 24	25	G 1/2	DLOI 1625LS	1
19 x 28	20	G 1	DLOI 1920LS	1
 <p>Soporte fijo Entrada : G 1/2 M para DLOI 1625 G 1 M para DLOI 1920 + 1 m de tubo Presión máx : 10 bar Temperatura : -15° C a +60° C</p>				

ENROLLADORES PARA AGUA CALIENTE ALTA PRESIÓN

Serie DMO - DGO - Acero alta presión - Tubo caucho reforzado alta presión

T2

Ø int./ext. (mm)	Long. (m)	Referencia	Emba.
8 x 15	15	DMO 0815HP	1
8 x 15	20	DGO 0820HP	1
 <p>Entrada : G 3/8 H Salida : G 3/8 M y enchufe M22 x 1,5 Presión : 400 bar Temperatura : -40° C a +150° C</p>			

Serie DMO - DGO - Inox alta presión - Tubo caucho reforzado alta presión

T2

Ø int./ext. (mm)	Long. (m)	Referencia	Emba.
8 x 15	15	DMO 0815HPI	1
8 x 15	20	DGO 0820HPI	1
 <p>Entrada : G 3/8 H Salida : G 3/8 M y enchufe M22 x 1,5 Presión : 400 bar Temperatura : -40° C a +150° C</p>			

Serie DMO - DGO - Inox alta presión - Tubo caucho reforzado alta presión

T2

Ø int./ext. (mm)	Long. (m)	Referencia	Emba.
8 x 15	3	DMG KITHP3	1
8 x 15	6	DMG KITHP6	1
 <p>Adaptable Enrolladores alta presión : M22 x 1,5 Máquina agua : G 3/8 H Presión : 400 bar</p>			

ENROLLADORES PARA AGUA SIN TUBO / ACERO

Serie DMO - DGO - Sin tubo - Acero alta presión

T2

Salida rosca macho BSPP	Entrada giratoria rosca hembra BSPP	Capacidad (m)	Referencia	Emba.
G 3/8	G 3/8	15	DMO NHP	1
G 3/8	G 3/8	20	DGO NHP	1
 <p>Presión : 400 bar</p>				

ENROLLADORES PARA AGUA SIN TUBO / INOX

Serie DMO - DGO - Sin tubo - Inox 304 Alta presión

T2

Capacidad (m)	Referencia	Emba.
15	DMO NHPI	1
20	DGO NHPI	1

Presión : 400 bar



Serie DMO - DGO - Sin tubo - Inox 304 baja presión

T2

Capacidad (m)	Referencia	Emba.
15	DMO NI	1
20	DGO NI	1

Presión : 60 bar



ENROLLADORES CON TUBOS PARA ACEITE Y GRASA

Serie DMO-DGO OIL - Tubo caucho - Aceite media presión

T2

Ø int./ext. (mm)	Long. (m)	Referencia	Emba.
13 x 19	10	DMO 1310OIL	1
13 x 19	15	DGO 1315OIL	1
13 x 19	20	DGO 1320OIL	1

Soporte fijo
Entrada : G 1/2 M
Presión máx : 60 bar
Temperatura : -10° C à +40° C



Serie DMO-DGO GR - Tubo caucho - Grasa alta presión

T2

Ø int./ext. (mm)	Long. (m)	Referencia	Emba.
6,4 x 14,7	10	DMO 0610GR	1
6,4 x 14,7	15	DMO 0615GR	1
6,4 x 14,7	20	DGO 0620GR	1

Soporte fijo
Entrada : G 1/4 F
Presión máx : 400 bar
Temperatura : -10° C à +100° C



ENROLLADORES PARA TUBO DE SOLDADURA

Serie DGO - Tubos emparejados sin enchufe de seguridad ISOFLAM

T2

Ø int./ext. (mm)	Long. (m)	Referencia	Emba.
10 x 17	15	DGO 10150A	1

Salida :
Oxígeno : G 3/8 hembra azul
Acetileno : G 3/8 hembra rojo
La gama ISOFLAM es conforme a los :
- Dispositivos de seguridad conformes a las normas :
* Internacionales : ISO 5175
* Europeas : EN 730
- Dispositivos de conexión conformes a las normas :
* Internacionales : ISO 7289
* Europeas : EN 5611



Serie DGO - Tubos emparejados con enchufe de seguridad ISOFLAM

T2

Ø int./ext. (mm)	Long. (m)	Referencia	Emba.
10 x 17	15	DGO 1015SIC	1

Salida :
Oxígeno : enchufe protección soldador SIO 061810S2
Acetileno : enchufe protección soldador SIA 061810S2
La gama ISOFLAM es conforme a los :
- Dispositivos de seguridad conformes a las normas :
* Internacionales : ISO 5175
* Europeas : EN 730
- Dispositivos de conexión conformes a las normas :
* Internacionales : ISO 7289
* Europeas : EN 5611



TUBOS DE ALIMENTACIÓN PARA ENROLLADORES

Tubo de enlace - Unión entre el enrollador y la tubería -
Longitud : 1 m

T2

Para enrolladores	Diámetro (mm)	Conexión (Tubo engastado)	Referencia	Emba.
DSF 0805 DRF 0812 DRF 0815 DRFB 0812 DRFB 0815	8 x 12	Enchufe de plástico	DMG 0448	1
DSF 1003 DRF 1010 DRF 1012 DRFB 1010 DRFB 1012	10 x 14	Enchufe de plástico	DMG 0449	1
DSFIN 0805	8 x 12	Enchufe de plástico	DMG 0448LPU	1
DRFIN 1012 DRFINB 1012	10 x 14	Enchufe de plástico	DMG 0449LPU	1
DMF 0810 DPF 0812	8 x 12	G 3/8 M	DMG 0161	1
DPF 1010 DVO 1025	10 x 15	G 3/8 M	DMG 0305	1
DMP 0830	8 x 12	G 1/4 F	DMP 0542	1
DMP 1025	10 x 14	G 3/8 F	DMP 0427	1
DMO 0810 DMO 0815 DMO 0820 DGF 0810 DGF 0815 DGF 0820	8 x 14	G 3/8 M	DMG T0801L	1
DMO 1010 DMO 1015 DMO 1020 DGO 1020 DGO 1025 DGF 1010 DGF 1015	10 x 17	G 3/8 M	DMG T1001L	1
DMO 1315 DGO 1320 DGF 1310	13 x 20	G 1/2 F	DMG T1301L	1
DLO 1330	13 x 20	G 1/2 F	DMG TF1301	1
DMO 1610 DGO 1610	16 x 23	G 1/2 F	DMG T1601L	1
DLO 1625 DLO 1630	16 x 24	G 1/2 F	DMG TF1601	1
DLO 1625LS DLOI 1625LS	16 x 24	G 1/2 F	DMG TF1601K	1
DMO 1610LS DGO 1615LS DMOI 1610LS DGOI 1615LS	16 x 24	G 1/2 F	DMG T1601KL	1
DLO 1920LS DLOI 1920LS	19 x 28	G 3/4 F	DMG TF1901K	1
DLO 1920	19 x 27	G 3/4 F	DMG TF1901	1

SOPORTE ORIENTABLE PARA ENROLLADORES ACERO INOX

Soporte orientable acero inox para enrollador

T2

Modelo (del enrollador)	Referencia	Emba.
Para DMOI	DMOI PIV2	1
Para DGOI	DGOI PIV2	1
Para DLOI	DLOI PIV	1



SOPORTE ORIENTABLE PARA ENROLLADORES

Soporte orientable para enrollador DGF

T2

Compatibilidad	Referencia	Emba.
Para DGF	DGF PIV	1



Soporte orientable para enrollador

T2

Modelo (de enrollador)	Referencia	Emba.
Para DMO	DMO PIV2	1
Para DGO	DGO PIV2	1
Para DLO	DLO PIV	1



ENROLLADORES DE CABLE ELÉCTRICO

Enrollador de cable eléctrico

T2

	Referencia	Emba.
	Potencia : 1,2 KW enrollado 1,8 KW desenrollado Long. : 14 m (+ 1 m en el exterior) Tensión de alimentación : 230 V Sección : Cable eléctrico : 3 G x 1,5 mm ² Material : Cable eléctrico : PVC H05V V-F	DEL 31514 1
	Potencia : 2 KW enrollado 3 KW desenrollado Long. : 17 m (+ 2 m en el exterior) Tensión de alimentación : 230 V Sección : Cable eléctrico : 3 G 2,5 mm ² Material : Cable eléctrico : Caucho H07 RN-F Alimentación : 230 V Protección enrollador : IP 42	DEL 32520 1

Enrollador de cable con lámpara de mano 230V

T2

	Referencia	Emba.
	Long. : 14 m (+ 1,5 m en el exterior) Tensión de alimentación : 230 V Sección : Cable eléctrico : 2 x 1 mm ² Material : Cable eléctrico : Caucho H05 RN-F Alimentación : 230 V Protección enrollador : IP 42	DEL BA230 1

Enrollador de cable con lámpara de mano 24 V

T2

	Referencia	Emba.
	Long. : 14 m (+ 1,5 m en el exterior) Protección : Enrollador : IP 42 Lámpara : IP 55 Tensión de alimentación : 24V Sección : Cable eléctrico : 2 x 1 mm ² Material : Cable eléctrico : Caucho H05 RN-F Enrollador con alimentación eléctrica de 24V	DEL BA24 1

TUBOS DE POLIAMIDA

Tubo de poliamida en caja de 25 m (unidad de venta = 1 caja)

T2

Ø int./ext. (mm)	Color	Referencia	Emba.
1,8 x 3	Azul	PAMBE 180325	1
1,8 x 3	Negro	PAMBK 180325	1
2 x 4	Azul	PAMBE 020425	1
2 x 4	Incolor	PAMCL 020425	1
2 x 4	Amarillo	PAMYW 020425	1
2 x 4	Negro	PAMBK 020425	1
2 x 4	Rojo	PAMRD 020425	1
2 x 4	Verde	PAMGN 020425	1
2,7 x 4	Azul	PAMBE 270425	1
2,7 x 4	Incolor	PAMCL 270425	1
2,7 x 4	Amarillo	PAMYW 270425	1
2,7 x 4	Negro	PAMBK 270425	1
2,7 x 4	Rojo	PAMRD 270425	1
2,7 x 4	Verde	PAMGN 270425	1
3 x 5	Azul	PAMBE 030525	1
3 x 5	Incolor	PAMCL 030525	1
3 x 5	Negro	PAMBK 030525	1
4 x 6	Azul	PAMBE 040625	1
4 x 6	Incolor	PAMCL 040625	1
4 x 6	Amarillo	PAMYW 040625	1
4 x 6	Negro	PAMBK 040625	1
4 x 6	Rojo	PAMRD 040625	1
4 x 6	Verde	PAMGN 040625	1
6 x 8	Azul	PAMBE 060825	1
6 x 8	Incolor	PAMCL 060825	1
6 x 8	Amarillo	PAMYW 060825	1
6 x 8	Negro	PAMBK 060825	1
6 x 8	Rojo	PAMRD 060825	1
6 x 8	Verde	PAMGN 060825	1
8 x 10	Azul	PAMBE 081025	1
8 x 10	Incolor	PAMCL 081025	1
8 x 10	Amarillo	PAMYW 081025	1
8 x 10	Negro	PAMBK 081025	1
8 x 10	Rojo	PAMRD 081025	1
8 x 10	Verde	PAMGN 081025	1
10 x 12	Azul	PAMBE 101225	1
10 x 12	Incolor	PAMCL 101225	1
10 x 12	Negro	PAMBK 101225	1
12 x 14	Azul	PAMBE 121425	1
12 x 14	Incolor	PAMCL 121425	1
12 x 14	Negro	PAMBK 121425	1
13 x 16	Azul	PAMBE 131625	1
13 x 16	Incolor	PAMCL 131625	1
13 x 16	Negro	PAMBK 131625	1



TUBOS DE POLIAMIDA

Tubo de poliamida en rollo de 100 m
(unidad de venta = 1 rollo)

T2

Ø int./ext. (mm)	Color	Referencia	Emba.
2 x 4	Azul	PAMBE 0204100	1
2 x 4	Incolor	PAMCL 0204100	1
2 x 4	Amarillo	PAMYW 0204100	1
2 x 4	Negro	PAMBK 0204100	1
2 x 4	Rojo	PAMRD 0204100	1
2 x 4	Verde	PAMGN 0204100	1
2,7 x 4	Azul	PAMBE 2704100	1
2,7 x 4	Incolor	PAMCL 2704100	1
2,7 x 4	Amarillo	PAMYW 2704100	1
2,7 x 4	Negro	PAMBK 2704100	1
2,7 x 4	Rojo	PAMRD 2704100	1
2,7 x 4	Verde	PAMGN 2704100	1
3 x 5	Azul	PAMBE 0305100	1
3 x 5	Incolor	PAMCL 0305100	1
3 x 5	Negro	PAMBK 0305100	1
4 x 6	Azul	PAMBE 0406100	1
4 x 6	Incolor	PAMCL 0406100	1
4 x 6	Amarillo	PAMYW 0406100	1
4 x 6	Negro	PAMBK 0406100	1
4 x 6	Rojo	PAMRD 0406100	1
4 x 6	Verde	PAMGN 0406100	1
6 x 8	Azul	PAMBE 0608100	1
6 x 8	Incolor	PAMCL 0608100	1
6 x 8	Amarillo	PAMYW 0608100	1
6 x 8	Negro	PAMBK 0608100	1
6 x 8	Rojo	PAMRD 0608100	1
6 x 8	Verde	PAMGN 0608100	1
8 x 10	Azul	PAMBE 0810100	1
8 x 10	Incolor	PAMCL 0810100	1
8 x 10	Amarillo	PAMYW 0810100	1
8 x 10	Negro	PAMBK 0810100	1
8 x 10	Rojo	PAMRD 0810100	1
8 x 10	Verde	PAMGN 0810100	1
10 x 12	Azul	PAMBE 1012100	1
10 x 12	Incolor	PAMCL 1012100	1
10 x 12	Negro	PAMBK 1012100	1
12 x 14	Azul	PAMBE 1214100	1
12 x 14	Incolor	PAMCL 1214100	1
12 x 14	Negro	PAMBK 1214100	1
13 x 16	Azul	PAMBE 1316100	1
13 x 16	Incolor	PAMCL 1316100	1
13 x 16	Negro	PAMBK 1316100	1



PA

TUBOS DE POLIAMIDA

Tubo de poliamida en rollo de 300 m
(unidad de venta = 1 rollo)

T2

Ø int./ext. (mm)	Color	Referencia	Emba.
8 x 10	Azul	PAMBE 0810300	1
8 x 10	Negro	PAMBK 0810300	1
8 x 10	Incolor	PAMCL 0810300	1
8 x 10	Verde	PAMGN 0810300	1
8 x 10	Rojo	PAMRD 0810300	1
8 x 10	Amarillo	PAMYW 0810300	1



PA

Tubo de poliamida en rollo de 500 m
(unidad de venta = 1 rollo)

T2

Ø int./ext. (mm)	Color	Referencia	Emba.
6 x 8	Azul	PAMBE 0608500	1
6 x 8	Incolor	PAMCL 0608500	1
6 x 8	Amarillo	PAMYW 0608500	1
6 x 8	Negro	PAMBK 0608500	1
6 x 8	Rojo	PAMRD 0608500	1
6 x 8	Verde	PAMGN 0608500	1



PA

TUBOS DE POLIAMIDA

Tubo de poliamida en rollo de 1000 m
(unidad de venta = 1 rollo)

T2

Ø int./ext. (mm)	Color	Referencia	Emba.
2,7 x 4	Azul	PAMBE 27041000	1
2,7 x 4	Incolor	PAMCL 27041000	1
2,7 x 4	Amarillo	PAMYW 27041000	1
2,7 x 4	Negro	PAMBK 27041000	1
2,7 x 4	Rojo	PAMRD 27041000	1
2,7 x 4	Verde	PAMGN 27041000	1
4 x 6	Azul	PAMBE 04061000	1
4 x 6	Incolor	PAMCL 04061000	1
4 x 6	Amarillo	PAMYW 04061000	1
4 x 6	Negro	PAMBK 04061000	1
4 x 6	Rojo	PAMRD 04061000	1
4 x 6	Verde	PAMGN 04061000	1



TUBOS DE POLIURETANO CON BASE ESTER

Tubo de poliuretano con base Ester en caja de 25 m
(unidad de venta = 1 caja)

T2

Ø int./ext. (mm)	Color	Referencia	Emba.
1,8 x 3	Negro	PUBK M180325	1
2,5 x 4	Negro	PUBK M250425	1
2,5 x 4	Azul	PUBE M250425	1
2,5 x 4	Incoloro	PUCR M250425	1
2,5 x 4	Verde	PUGN M250425	1
2,5 x 4	Amarillo	PUYW M250425	1
2,5 x 4	Gris	PUGY M250425	1
2,5 x 4	Rojo	PURD M250425	1
3 x 5	Negro	PUBK M030525	1
3 x 5	Azul	PUBE M030525	1
4 x 6	Negro	PUBK M040625	1
4 x 6	Azul	PUBE M040625	1
4 x 6	Incoloro	PUCR M040625	1
4 x 6	Verde	PUGN M040625	1
4 x 6	Amarillo	PUYW M040625	1
4 x 6	Gris	PUGY M040625	1
4 x 6	Rojo	PURD M040625	1
5,5 x 8	Negro	PUBK M550825	1
5,5 x 8	Azul	PUBE M550825	1
5,5 x 8	Incoloro	PUCR M550825	1
5,5 x 8	Verde	PUGN M550825	1
5,5 x 8	Amarillo	PUYW M550825	1
5,5 x 8	Gris	PUGY M550825	1
5,5 x 8	Rojo	PURD M550825	1
7 x 10	Negro	PUBK M071025	1
7 x 10	Azul	PUBE M071025	1
7 x 10	Incoloro	PUCR M071025	1
7 x 10	Verde	PUGN M071025	1
7 x 10	Amarillo	PUYW M071025	1
7 x 10	Gris	PUGY M071025	1
7 x 10	Rojo	PURD M071025	1
8 x 12	Negro	PUBK M081225	1
8 x 12	Azul	PUBE M081225	1
8 x 12	Incoloro	PUCR M081225	1
9,5 x 14	Negro	PUBK M951425	1
9,5 x 14	Azul	PUBE M951425	1
9,5 x 14	Incoloro	PUCR M951425	1
11 x 16	Negro	PUBK M111625	1



PRODUCTOS ASOCIADOS

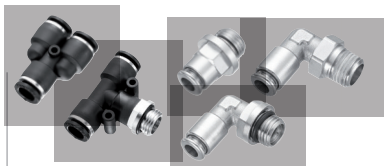

Enchufes instantáneos
CONEX - p 47



Corta tubos - p 70

Precio por metro

TUBOS DE POLIURETANO CON BASE ESTER

Tubo de poliuretano con base Ester en rollo de 100 m (unidad de venta = 1 rollo)

T2

Ø int./ext. (mm)	Color	Referencia	Emba.
2,5 x 4	Negro	PUBK M2504100	1
2,5 x 4	Azul	PUBE M2504100	1
2,5 x 4	Incoloro	PUCR M2504100	1
2,5 x 4	Verde	PUGN M2504100	1
2,5 x 4	Amarillo	PUYW M2504100	1
2,5 x 4	Gris	PUGY M2504100	1
2,5 x 4	Rojo	PURD M2504100	1
4 x 6	Negro	PUBK M0406100	1
4 x 6	Azul	PUBE M0406100	1
4 x 6	Incoloro	PUCR M0406100	1
4 x 6	Verde	PUGN M0406100	1
4 x 6	Amarillo	PUYW M0406100	1
4 x 6	Gris	PUGY M0406100	1
4 x 6	Rojo	PURD M0406100	1
5,5 x 8	Negro	PUBK M5508100	1
5,5 x 8	Azul	PUBE M5508100	1
5,5 x 8	Incoloro	PUCR M5508100	1
5,5 x 8	Verde	PUGN M5508100	1
5,5 x 8	Amarillo	PUYW M5508100	1
5,5 x 8	Gris	PUGY M5508100	1
5,5 x 8	Rojo	PURD M5508100	1
7 x 10	Negro	PUBK M0710100	1
7 x 10	Azul	PUBE M0710100	1
7 x 10	Incoloro	PUCR M0710100	1
8 x 12	Negro	PUBK M0812100	1
8 x 12	Azul	PUBE M0812100	1
8 x 12	Incoloro	PUCR M0812100	1
9,5 x 14	Negro	PUBK M9514100	1



PU

TUBOS DE POLIURETANO CON BASE ETHER

Tubo de poliuretano con base Ether en caja de 25 m (unidad de venta = 1 caja)

T2

Ø int./ext. (mm)	Color	Referencia	Emba.
2,5 x 4	Negro	PHBK M250425	1
2,5 x 4	Azul	PHBE M250425	1
2,5 x 4	Incoloro	PHCR M250425	1
4 x 6	Negro	PHBK M040625	1
4 x 6	Azul	PHBE M040625	1
4 x 6	Incoloro	PHCR M040625	1
5,5 x 8	Negro	PHBK M550825	1
5,5 x 8	Azul	PHBE M550825	1
5,5 x 8	Incoloro	PHCR M550825	1
7 x 10	Azul	PHBE M071025	1
7 x 10	Negro	PHBK M071025	1
7 x 10	Incoloro	PHCR M071025	1
8 x 12	Negro	PHBK M081225	1
8 x 12	Azul	PHBE M081225	1
8 x 12	Incoloro	PHCR M081225	1
9,5 x 14	Incoloro	PHCR M951425	1



PH

Tubo de poliuretano con base Ether en rollo de 100 m (unidad de venta = 1 rollo)

T2

Ø int./ext. (mm)	Color	Referencia	Emba.
2,5 x 4	Negro	PHBK M2504100	1
2,5 x 4	Azul	PHBE M2504100	1
2,5 x 4	Incoloro	PHCR M2504100	1
4 x 6	Negro	PHBK M0406100	1
4 x 6	Azul	PHBE M0406100	1
4 x 6	Incoloro	PHCR M0406100	1
5,5 x 8	Negro	PHBK M5508100	1
5,5 x 8	Azul	PHBE M5508100	1
5,5 x 8	Incoloro	PHCR M5508100	1
7 x 10	Negro	PHBK M0710100	1
7 x 10	Azul	PHBE M0710100	1
7 x 10	Incoloro	PHCR M0710100	1
8 x 12	Negro	PHBK M0812100	1
8 x 12	Azul	PHBE M0812100	1
8 x 12	Incoloro	PHCR M0812100	1



PH

PRODUCTOS ASOCIADOS

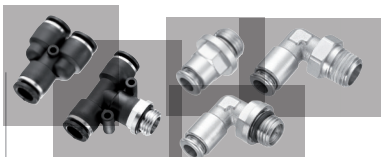

Enchufes instantáneos
CONEX - p 47



Corta tubos - p 70

PRODUCTOS ASOCIADOS



Enchufes instantáneos
CONEX - p 47



Corta tubos - p 70

TUBOS EN ROLLO

Tubo de PVC DIFLEX - en rollo

T2

Ø int./ext. (mm)	Rollo (m)	Color	Referencia	Emba.
6 x 12	50	Azul	DIFLEX 6	50
8 x 14	50	Azul	DIFLEX 8	50
8 x 14	50	Rojo	DIFLEX 8RG	50
8 x 14	25	Azul	DIFLEX 8C25	25
9 x 15	50	Azul	DIFLEX 9	50
10 x 16	50	Azul	DIFLEX 10	50
10 x 16	50	Rojo	DIFLEX 10RG	50
10 x 16	25	Azul	DIFLEX 10C25	25
12 x 19	50	Azul	DIFLEX 12	50
12 x 19	50	Rojo	DIFLEX 12RG	50
13 x 20	50	Azul	DIFLEX 13	50
13 x 20	50	Rojo	DIFLEX 13RG	50
16 x 22	25	Azul	DIFLEX 16	25
19 x 26	25	Azul	DIFLEX 19	25
25 x 33	25	Azul	DIFLEX 25	25
32 x 42	25	Incoloro	DIFLEX 32	25
38 x 48	25	Incoloro	DIFLEX 38	25
50 x 64	25	Incoloro	DIFLEX 50	25

Temperatura : -15°C a +60°C

ALIMENTICIO

Precio por metro

Tubo de caucho AIRCA - en rollo

T2

Ø int./ext. (mm)	Rollo (m)	Referencia	Emba.
6 x 13	40	AIRCA 6	40
8 x 15	40	AIRCA 8	40
8 x 15	20	AIRCA 8C20	20
10 x 18	40	AIRCA 10	40
13 x 22	40	AIRCA 13	40
16 x 25	40	AIRCA 16	40
19 x 28	40	AIRCA 19	40
25 x 34	40	AIRCA 25	40

Temperatura : -40°C a +70°C

Precio por metro

TUBOS EN ROLLO

Tubo envainado de PVC SURFLEX - en rollo

T2

Ø int./ext. (mm)	Rollo (m)	Referencia	Emba.
6,3 x 11	50	SURFLEX 6	50
6,3 x 11	30	SURFLEX 6C30	30
8 x 13	50	SURFLEX 8	50
8 x 13	30	SURFLEX 8C30	30
9 x 14,5	50	SURFLEX 9	50
9 x 14,5	30	SURFLEX 9C30	30
10 x 15	50	SURFLEX 10	50
10 x 15	30	SURFLEX 10C30	30
12,7 x 19	50	SURFLEX 13	50
12,7 x 19	30	SURFLEX 13C30	30

Temperatura : -20°C a +60°C

Precio por metro

Tubo antiestático caucho STOFLEX - en rollo

T2

Ø int./ext. (mm)	Rollo (m)	Referencia	Emba.
8 x 15	50	STOFLEX 8	50
9 x 16	50	STOFLEX 9	50
10 x 18	50	STOFLEX 10	50

Temperatura : -40°C a +100°C

PINTURA

Precio por metro

Tubo de poliuretano VALYFLEX - en rollo

T2

Ø int./ext. (mm)	Rollo (m)	Referencia	Emba.
8 x 14	30	VALYFLEX 8	30
10 x 16	30	VALYFLEX 10	30
12,7 x 19	30	VALYFLEX 13	30

Temperatura : 15°C a +60°C

Precio por metro

TUBOS EN ROLLO

Tubo autoblocante LOCKFLEX NBR/PVC

T2

	Ø int./ext. (mm)	Rollo (m)	Referencia	Emba.
	10 x 17,5	20	LOCKFLEX 10BL	20
	10 x 17,5	20	LOCKFLEX 10RG	20
	13 x 20,4	20	LOCKFLEX 13BL	20
	13 x 20,4	20	LOCKFLEX 13RG	20
Puede ser montado sin abrazaderas con las uniones, referencia AF + conectores CPI *CNRE, CPI *CNRO, CPI *CN Temperatura : +3°C à +90°C				

Precio por metro

Tubo de poliuretano ENROULEX (especial enrolladores)

T2

	Ø int./ext. (mm)	Rollo (m)	Referencia	Emba.
	8 x 12	120	ENROULEX 8	1
	10 x 14	90	ENROULEX 10	1
Temperatura : -20°C à +75°C				

Tubo de caucho industrial DOLEX - calidad alimentación

T2

	Ø int./ext. (mm)	Rollo (m)	Referencia	Emba.
	15,8 x 24	20	DOLEX 15	20
	19,4 x 28,4	20	DOLEX 19	20
Temperatura : -20°C à +95°C				

ALIMENTICIO

Precio por metro

Tubo de PVC antitorsión HOFLEX

T2

	Ø int./ext. (mm)	Rollo (m)	Referencia	Emba.
	15 x 21	25	HOFLEX 15	25
Temperatura : -20°C à +60°C				

Precio por metro

TUBO DE SOLDADURA OXIGENO Y ACETILENO

Tubo de soldadura en rollo (20 m)

T1

	Ø int./ext. (mm)	Fluido	Referencia	Emba.
	6 x 12	Oxígeno	TUB OX6	20
	6 x 12	Acetileno	TUB SET6	20
	10 x 17	Oxígeno	TUB OX10	20
	10 x 17	Acetileno	TUB SET10	20
Tubo conducto simple Presión de uso a 20°C : 20 bar Presión de ruptura a 20 °C : 60 bar Temperatura máx. de uso : + 60°C				

Precio por metro

Tubo doble conducto desolidarizable (20 m)

T1

	Ø int./ext. (mm)	Referencia	Emba.
	6 x 12	TUB OA6	20
	10 x 17	TUB OA10	20
Tubo doble conducto desolidarizable oxígeno y acetileno Presión de uso a 20°C : 20 bar Presión de ruptura a 20 °C : 60 bar Temperatura máx. de uso : + 60°C			

Precio por metro

ALARGADORES DE MANGUERA RESISTENTES A LOS ACEITES

Manguera AIRCA provistos de enchufes rápidos prevoS1

T1

Ø int./ext. (mm)	Long. (m)	Enchufe	Referencia	Emba.
8 x 15	10	ISI 06	RAL AISB810	1
10 x 18	5	ISI 06	RAL AISB105	1
10 x 18	10	ISI 06	RAL AISB1010	1
13 x 22	10	ISI 08	RAL AIS1310	1
8 x 15	10	ESI 07	RAL AESB810	1
10 x 18	10	ESI 07	RAL AESB1010	1
10 x 18	5	ESI 07	RAL AESB105	1
13 x 22	10	ESI 07	RAL AES1310	1
8 x 15	10	CSI 06	RAL ACSB810	1
10 x 18	5	CSI 06	RAL ACSB105	1
10 x 18	10	CSI 06	RAL ACSB1010	1
13 x 22	10	CSI 08	RAL ACS1310	1
Montada con abrazaderas de oreja e protectores				



ALARGADORES DE MANGUERA RESISTENTES A LOS ACEITES

Manguera engastada AIRCA provistos de enchufes rápidos ISG "alto caudal"

T1

Ø int./ext. (mm)	Long. (m)	Enchufe	Referencia	Emba.
13 x 22	10	ISG 11	RAL AIG1310	1
13 x 22	20	ISG 11	RAL AIG1320	1
16 x 25	10	ISG 11	RAL AIG1610	1
16 x 25	20	ISG 11	RAL AIG1620	1
19 x 28	10	ISG 11	RAL AIG1910	1
19 x 28	20	ISG 11	RAL AIG1920	1
Montada con abrazaderas de oreja				



TRABAJOS PESADOS

Manguera engastada AIRCA provistos de enchufes rápidos prevoS1

T1

Ø int./ext. (mm)	Long. (m)	Enchufe	Referencia	Emba.
8 x 15	10	ISI 06	RST AISB810	1
10 x 18	10	ISI 06	RST AISB1010	1
13 x 22	10	ISI 08	RST AIS1310	1
8 x 15	10	ESI 07	RST AESB810	1
10 x 18	10	ESI 07	RST AESB1010	1
13 x 22	10	ESI 07	RST AES1310	1
8 x 15	10	CSI 06	RST ACSB810	1
10 x 18	10	CSI 06	RST ACSB1010	1
13 x 22	10	CSI 08	RST ACS1310	1



Manguera AIRCA provistos de enchufes rápidos prevoS1 ESI 11CB

T1

Ø int./ext. (mm)	Long. (m)	Enchufe	Referencia	Emba.
13 x 22	10	ESI 11CB	RAL AESL1310	1
13 x 22	20	ESI 11CB	RAL AESL1320	1
16 x 25	10	ESI 11CB	RAL AESL1610	1
16 x 25	20	ESI 11CB	RAL AESL1620	1
Montada con abrazaderas de oreja				



TRABAJOS PESADOS

Manguera AIRCA provistos de enchufe rápidos metálicos de seguridad

T1

Ø int./ext. (mm)	Long. (m)	Enchufe	Referencia	Emba.
16 x 25	10	ISI 11	RAL AIS1610	1
16 x 25	20	ISI 11	RAL AIS1620	1
19 x 28	10	ISI 11	RAL AIS1910	1
19 x 28	20	ISI 11	RAL AIS1920	1
16 x 25	10	ESI 11	RAL AES1610	1
16 x 25	20	ESI 11	RAL AES1620	1
19 x 28	10	ESI 11	RAL AES1910	1
19 x 28	20	ESI 11	RAL AES1920	1
8 x 15	10	CSM 06	RAL ACMB810	1
10 x 18	10	CSM 06	RAL ACMB1010	1
13 x 22	10	CSM 08	RAL ACM1310	1
16 x 25	10	CSM 11	RAL ACM1610	1
16 x 25	20	CSM 11	RAL ACM1620	1
19 x 28	10	CSM 11	RAL ACM1910	1
19 x 28	20	CSM 11	RAL ACM1920	1
Montada con abrazaderas de oreja				



Manguera AIRCA provistos de enchufes orientables prevoS1

T1

Ø int./ext. (mm)	Long. (m)	Enchufe	Referencia	Emba.
8 x 15	10	ISI 06SW	RAL AISW810	1
10 x 18	10	ISI 06SW	RAL AISW1010	1
13 x 22	10	ISI 08SW	RAL AISW1310	1
8 x 15	10	ESI 07SW	RAL AESW810	1
10 x 18	10	ESI 07SW	RAL AESW1010	1
13 x 22	10	ESI 07SW	RAL AESW1310	1
8 x 15	10	CSI 06SW	RAL ACSW810	1
10 x 18	10	CSI 06SW	RAL ACSW1010	1
13 x 22	10	CSI 08SW	RAL ACSW1310	1
Montada con abrazaderas de oreja e protectores				



ALARGADORES DE MANGUERA RESISTENTES A LOS ACEITES

Manguera engastada AIRCA provistos de enchufes orientables prevoS1

T1

Ø int./ext. (mm)	Long. (m)	Enchufe	Referencia	Emba.
8 x 15	10	ISI 06SW	RST AISW810	1
10 x 18	10	ISI 06SW	RST AISW1010	1
13 x 22	10	ISI 08SW	RST AISW1310	1
8 x 15	10	ESI 07SW	RST AESW810	1
10 x 18	10	ESI 07SW	RST AESW1010	1
13 x 22	10	ESI 07SW	RST AESW1310	1
8 x 15	10	CSI 06SW	RST ACSW810	1
10 x 18	10	CSI 06SW	RST ACSW1010	1
13 x 22	10	CSI 08SW	RST ACSW1310	1

ALARGADORES DE MANGUERA DE CAUCHO ANTIESTÁTICO

Manguera de caucho antiestático STOFLEX antirrayaduras con enchufes rapidos prevoS1

T1

Ø int./ext. (mm)	Long. (m)	Enchufe	Referencia	Emba.
8 x 15	10	ISI 06	RAL SISB810	1
10 x 18	12,5	ISI 06	RAL SISB1012	1
8 x 15	10	ESI 07	RAL SESB810	1
10 x 18	12,5	ESI 07	RAL SESB1012	1
8 x 15	10	CSI 06	RAL SCSB810	1
10 x 18	12,5	CSI 06	RAL SCSB1012	1

Montada con abrazaderas de oreja e protectores

PINTURA

Manguera engastada en caucho EPDM antiestático STOFLEX antirrayaduras con enchufes rapidos prevoS1

T1

Ø int./ext. (mm)	Long. (m)	Enchufe	Referencia	Emba.
8 x 15	10	ISI 06	RST SISB810	1
10 x 18	12,5	ISI 06	RST SISB1012	1
8 x 15	10	ESI 07	RST SESB810	1
10 x 18	12,5	ESI 07	RST SESB1012	1
8 x 15	10	CSI 06	RST SCSB810	1
10 x 18	12,5	CSI 06	RST SCSB1012	1

PINTURA

MANGUITO PARA ENLACE - TUBO EN CAUCHO AIRCA PARA HERRAMIENTAS NEUMÁTICAS

Manguito para enlace

T1

Ø int./ext. (mm)	Conector	Rosca	Referencia	Emba.
10 x 18	IRP 06	R 1/4	MAI 061410	1
10 x 18	IRP 06	R 1/2	MAI 061210	1
13 x 22	IRP 08	R 3/8	MAI 083813	1
13 x 22	IRP 08	R 1/2	MAI 081213	1
16 x 25	IRP 11	R 1/2	MAI 111216	1
16 x 25	IRP 11	R 3/4	MAI 113416	1
10 x 18	ERP 07	R 1/4	MAE 071410	1
13 x 22	ERP 07	R 3/8	MAE 073813	1
10 x 18	CRP 06	R 1/4	MAC 061410	1
13 x 22	CRP 08	R 3/8	MAC 083813	1

Long. 0.4 m

Manguera de caucho antiestático STOFLEX provistos de enchufes orientables prevoS1

T1

Ø int./ext. (mm)	Long. (m)	Enchufe	Referencia	Emba.
8 x 15	10	ISI 06SW	RAL SISW810	1
10 x 18	12,5	ISI 06SW	RAL SISW1012	1
8 x 15	10	ESI 07SW	RAL SESW810	1
10 x 18	12,5	ESI 07SW	RAL SESW1012	1
8 x 15	10	CSI 06SW	RAL SCSW810	1
10 x 18	12,5	CSI 06SW	RAL SCSW1012	1

Montada con abrazaderas de oreja e protectores

PINTURA

Manguera engastada STOFLEX provistos de enchufes orientables prevoS1

T1

Ø int./ext. (mm)	Long. (m)	Enchufe	Referencia	Emba.
8 x 15	10	ISI 06SW	RST SISW810	1
10 x 18	12,5	ISI 06SW	RST SISW1012	1
8 x 15	10	ESI 07SW	RST SESW810	1
10 x 18	12,5	ESI 07SW	RST SESW1012	1
8 x 15	10	CSI 06SW	RST SCSW810	1
10 x 18	12,5	CSI 06SW	RST SCSW1012	1

PINTURA

ALARGADORES DE MANGUERA PVC PARA AIRE NON LUBRICADO

Manguera PVC DIFLEX con enchufe rápido prevoS1

T1

Ø int./ext. (mm)	Long. (m)	Enchufe	Referencia	Emba.
8 x 14	10	ISI 06	RAL DISB810	1
8 x 14	10	ESI 07	RAL DESB810	1
8 x 14	10	CSI 06	RAL DCSB810	1
Montada con abrazaderas de oreja e protectores				



Manguera PVC "SURFLEX" con enchufe rápido prevoS1

T1

Ø int./ext. (mm)	Long. (m)	Enchufe	Referencia	Emba.
8 x 13	10	ESI 07	RAL XESB810	1
8 x 13	12,5	ESI 07	RAL XESB812	1
8 x 13	15	ESI 07	RAL XESB815	1
Montada con abrazaderas de oreja e protezioni				



ALARGADORES DE MANGUERA ALTA FLEXIBILIDAD DE POLÍMERO HIBRIDO

Alargadores de manguera alta flexibilidad de polímero híbrido FLEXAIR con enchufes rápidos prevoS1

T1

NUEVO	Ø int./ext. (mm)	Long. (m)	Enchufe	Referencia	Emba.
	10 x 16	10	ISI 06	RAL RISB1010	1
	10 x 16	10	ESI 07	RAL RESB1010	1
	10 x 16	10	CSI 06	RAL RCSB1010	1
Montada con abrazaderas de oreja e protectors					



TUBOS PARA CIRCUITOS DE AGUA

Prolongador de tubo PVC equipado con enchufe de obturación y conector

T1

Ø int./ext. (mm)	Long. (m)	Referencia	Emba.
15 x 21	25	RAL 1525TLS	1
Equipado de enchufes ELS 091815 y ELP 096815			



SOPORTE DE TUBO

Soporte para tubos

T2

Composición	Referencia	Emba.
Soporte para tubos con : - 1 gancho para pistola de soplado - 1 kit de tornillos y tuercas - 2 tapones de relleno en caucho	PLA HR	1
Soporte para tubos con : - 1 kit de iman	PLA HRM	1



Soporte de tubo Inox 304

T2

Dénominación	Referencia	Emba.
Soporte fijación mural Longitud : 25 m de tubo	EHS 25	1



TUBOS EN ESPIRAL DE POLIURETANO CON ENCHUFES

Mini tubo en espiral de poliuretano : equipado con enchufes instantáneos CONEX - RPD MG

T2

Rosca macho BSPP	Ø int./ext. (mm)	Longitud máx. (m)	Referencia	Emba.
G 1/8	2,5 x 4	2	PUS 22	1
G 1/8	2,5 x 4	4	PUS 24	1
G 1/4	4 x 6	2	PUS 42	1
G 1/4	4 x 6	4	PUS 44	1



Tubo en espiral de poliuretano : equipado con enchufes macho fijo y rotativo

T2

Rosca macho BSPT	Ø int./ext. (mm)	Longitud máx. (m)	Referencia	Emba.
R 1/4	5 x 8	2	PUS 52	1
R 1/4	5 x 8	4	PUS 54	1
R 1/4	5 x 8	6	PUS 56	1
R 1/4	5 x 8	8	PUS 58	1
R 1/4	6,5 x 10	4	PUS 64	1
R 1/4	6,5 x 10	6	PUS 66	1
R 1/4	6,5 x 10	8	PUS 68	1
R 1/4	6,5 x 10	10	PUS 610	1
R 3/8	8 x 12	4	PUS 84	1
R 3/8	8 x 12	6	PUS 86	1
R 3/8	8 x 12	8	PUS 88	1
R 3/8	8 x 12	15	PUS 815	1



Tubo en espiral de poliuretano : equipado con enchufes macho fijo y rotativo

T2

Rosca macho BSPT	Ø int./ext. (mm)	Longitud máx. (m)	Referencia	Emba.
R 1/4	6,5 x 10	4	PUS 64R	1
R 1/4	6,5 x 10	6	PUS 66R	1



TUBOS EN ESPIRAL DE POLIURETANO CON ENCHUFES

Tubo en espiral de poliuretano : equipado con enchufes macho fijo y rotativo

T2

Rosca macho BSPT	Ø int./ext. (mm)	Longitud máx. (m)	Referencia	Emba.
R 1/4	6,5 x 10	4	PUS 64J	1
R 1/4	6,5 x 10	6	PUS 66J	1



Tubo en espiral de poliuretano : equipado con enchufes macho fijo y rotativo

T2

Rosca macho BSPT	Ø int./ext. (mm)	Longitud máx. (m)	Referencia	Emba.
R 1/4	6,5 x 10	4	PUS 64V	1
R 1/4	6,5 x 10	6	PUS 66V	1



Tubo en espiral de poliuretano : equipado con enchufes macho fijo y rotativo

T2

Rosca macho BSPT	Ø int./ext. (mm)	Longitud máx. (m)	Referencia	Emba.
R 1/4	6,5 x 10	4	PUS 64NR	1
R 1/4	6,5 x 10	6	PUS 66NR	1



Tubo en espiral de poliuretano : equipado con enchufes macho rotativo

T2

Rosca macho BSPT	Ø int./ext. (mm)	Longitud máx. (m)	Referencia	Emba.
R 1/4	6,5 x 10	8	PUS 68FF	1
R 3/8	8 x 12	6	PUS 86FF	1
R 1/2	11 x 16	4	PUS 114	1
R 1/2	11 x 16	8	PUS 118	1



TUBOS EN ESPIRAL DE POLIURETANO Y PVC CON ENCHUFES FIJOS

Tubo en espiral de poliuretano y PVC : equipado con enchufes machos fijos - SOLDADURA especial

T2

Ø int./ext. (mm)	Longitud máx. (m)	Referencia	Emba.
6,5 x 12	7,5	PUS 66CX	1
8 x 14	7,5	PUS 86CX	1

Taller para usos intensivos con estaciones de trabajo de alta exigencia
Talleres de soldadura, amolado, desbarbado, discado
Circuitos de refrigeración molde y prensa de inyección



TUBOS EN ESPIRAL DE POLIAMIDA

Tubo en espiral de poliamida con enchufes macho rotativos

T2

Rosca macho BSPP	Ø int./ext. (mm)	Longitud máx. (m)	Referencia	Emba.
G 1/4	6 x 8	2,5	SPIC 62	1
G 1/4	6 x 8	5	SPIC 65	1
G 1/4	6 x 8	10	SPIC 610	1
G 1/4	6 x 8	20	SPIC 620	1
G 1/4	8 x 10	2,5	SPIC 82	1
G 1/4	8 x 10	5	SPIC 85	1
G 1/4	8 x 10	10	SPIC 810	1
G 1/4	8 x 10	20	SPIC 820	1
G 3/8	9,5 x 12	2,5	SPIC 102	1
G 3/8	9,5 x 12	4	SPIC 104	1
G 3/8	9,5 x 12	17	SPIC 1016	1
G 3/8	9,5 x 12	8,5	SPIC 108	1



Tubo en espiral de poliamida con enchufes macho fijos

T2

Rosca macho BSPP	Ø int./ext. (mm)	Longitud máx. (m)	Referencia	Emba.
G 1/4	6 x 8	5	SPIC 65FX	1
G 1/4	6 x 8	10	SPIC 610FX	1
G 1/4	8 x 10	5	SPIC 85FX	1
G 1/4	8 x 10	10	SPIC 810FX	1



TUBOS EN ESPIRAL DE POLIURETANO CON ENCHUFE RÁPIDO Y CONECTOR

Tubos en espiral de poliuretano con enchufes rápidos

T2

Ø int./ext. (mm)	Enchufe	Longitud máx. (m)	Referencia	Emba.
5 x 8	ESI 07	2	PUS 52ES	1
5 x 8	ESI 07	4	PUS 54ES	1
6,5 x 10	ESI 07	4	PUS 64ES	1
6,5 x 10	ESI 07	6	PUS 66ES	1
6,5 x 10	ESI 07	8	PUS 68ES	1
8 x 12	ESI 07	8	PUS 88ES	1
6,5 x 10	ISI 06	4	PUS 64IS	1
6,5 x 10	ISI 06	6	PUS 66IS	1
6,5 x 10	ISI 06	8	PUS 68IS	1
8 x 12	ISI 06	6	PUS 86IS	1
8 x 12	ESI 07	4	PUS 84ES	1
8 x 12	ESI 07	6	PUS 86ES	1



Tubo en espiral de poliamida "especial extremidades levantadas" - enchufes macho fijos

T2

Rosca macho BSPP	Ø int./ext. (mm)	Longitud máx. (m)	Referencia	Emba.
G 1/4	6,5 x 8	5	SPI 95	1



Tubo en espiral de poliamida sin enchufe

T2

Ø int./ext. (mm)	Longitud máx. (m)	Referencia	Emba.
2,7 x 4	10	SPIR 2710	1
4,5 x 6	9	SPIR 456	1
4 x 6	26	SPIR 4526	1
6 x 8	10	SPIR 610	1
6 x 8	20	SPIR 620	1
8 x 10	20	SPIR 820	1
9,5 x 12	17	SPIR 1016	1
12,7 x 16	24	SPIR 12730	1
16 x 20	20	SPIR 1630	1



TUBOS EN ESPIRAL EQUIPADO CON PISTOLA DE SOPLADO

Conjunto de soplado poliuretano

T2

	Referencia	Emba.
	Rosca macho BSPT : R 1/4 Long. : 2 m Equipado con : 1 pistola de soplado 27102 MTL 1 tubo en espiral de poliuretano PUS 52	HELICOL 6P 1
	Rosca macho BSPT : R 1/4 Long. : 4 m Equipado con : 1 pistola de soplado 27102 MTL 1 tubo en espiral de poliuretano PUS 54	HELICOL 7P 1

Conjunto de soplado con conexión fija

T2

	Referencia	Emba.
	Rosca macho BSPP : G 1/4 Long. : 5 m Equipado con : 1 pistola de soplado 27102 MTL 1 tubo en espiral de poliamida SPI 95	HELICOL 3 1

Conjunto de soplado con BGM 104, tubo espiral y enchufe rápido estándar

T2

	Referencia	Emba.
	Enchufe : IRC 06 Long. : 2 m Equipado con : 1 tubo en espiral de poliuretano PUS 52 1 enchufe IRC 06 y 2 conectores IRP 06 1 pistola de soplado BGM 104	HELICOL 9 1

Conjunto con pistola de soplado a deformación - Empalme fijo

T2

	Referencia	Emba.
	Rosca macho BSPP : G 1/4 Long. : 4 m Equipado con : 1 tubo en espiral de poliuretano 1 pistola de soplado antirrayaduras	HELICOL 4 1
Incluye :		
	1 tubo en espiral de poliuretano G 1/4 M	
	1 pistola de soplado antirrayaduras	

Conjunto con 27102 MTL, espiral, conector y enchufe de seguridad

T2

Ø int./ext. (mm)	Enchufe	Long. (máx.(m))	Referencia	Emba.
5 x 8	ESI 07	4	PUS 54BES	1
6,5 x 10	ESI 07	6	PUS 66BES	1
6,5 x 10	ESI 07	8	PUS 68BES	1
5 x 8	ISI 06	2	PUS 52BIS	1
5 x 8	ISI 06	4	PUS 54BIS	1
6,5 x 10	ISI 06	4	PUS 64BIS	1
6,5 x 10	ISI 06	6	PUS 66BIS	1
6,5 x 10	ISI 06	8	PUS 68BIS	1
Incluye :				
- 1 tubo en espiral de poliuretano				
- 1 enchufe previo S1				
- 2 conectores				
- 1 pistola de soplado 27102 MTL				

EQUILIBRADORES DE ALIMENTACIÓN CON TUBO EN ESPIRAL

Equilibradores con manguera espiral

T2

Salida de aire (BSPP)	Peso (de la herramienta)(kg))	Referencia	Emba.
G 1/4 M	0,2 a 0,5	SPI 1	1
G 1/4 F	0,7 a 2	SPI 3	1
G 3/8 F	2,5 a 5	SPI 5	1
G 3/8 F	6 a 10	SPI 7	1

ENCHUFES PARA TUBOS EN ESPIRAL DE POLIURETANO

Enchufe rotativo con tratamiento previo Teflón "especial poliuretano"

T2

Rosca macho BSPT	Ø int./ext. (mm)	Referencia	Emba.
R 1/4	5 x 8	PUR 813R	1
R 1/4	6,5 x 10	PUR 1013R	1
R 3/8	8 x 12	PUR 1238R	1

Enchufe fijo con tratamiento previo Teflón "especial poliuretano"

T2

Rosca macho BSPT	Ø int./ext. (mm)	Referencia	Emba.
R 1/4	5 x 8	PUR 813F	1
R 1/4	6,5 x 10	PUR 1013F	1
R 3/8	8 x 12	PUR 1238F	1
R 1/2	11 x 16	PUR 1121F	1

ENCHUFES PARA TUBOS DE POLIAMIDA

Enchufe rotativo "especial poliamida"

T2

Rosca (BSPP)	Ø int./ext. (mm)	Referencia	Emba.
G 1/4 M	4 x 6	20	1
G 1/4 M	6 x 8	22	1
G 1/4 M	8 x 10	25	1
G 3/8 M	8 x 10	25M38	1
G 3/8 M	10 x 12	27	1
G 3/8 F	10 x 12	27F38	1

Enchufe fijo "especial poliamida"

T2

Rosca macho BSPP	Ø int./ext. (mm)	Referencia	Emba.
G 1/4	4 x 6	20FX	1
G 1/4	6 x 8	22FX	1
G 1/4	8 x 10	25FX	1
G 3/8	10 x 12	27FX	1
G 1/2	12,7 x 16	29FX	1
G 3/4	16 x 20	30FX	1

ABRAZADERAS DE 1 OREJA

Abrazaderas de 1 oreja acero tratado

T5

	Ø min./máx. (mm)	Referencia	Emba.
	7 - 9	0709E	100
	8 - 10	0810E	100
	9 - 11	0911E	100
	10 - 12	1012E	100
	11 - 13	1113E	100
	12 - 14	1214E	100
	14 - 16	1416E	100
	16 - 18	1618E	100

Precio por 100

Abrazaderas de 1 oreja Inox 304

T5

	Ø min./máx. (mm)	Referencia	Emba.
	7 - 9	INOX 0709E	100
	8 - 10	INOX 0810E	100
	9 - 11	INOX 0911E	100
	10 - 12	INOX 1012E	100
	11 - 13	INOX 1113E	100
	12 - 14	INOX 1214E	100
	13 - 15	INOX 1315E	100
	14 - 16	INOX 1416E	100
	15 - 17	INOX 1517E	100
	16 - 18	INOX 1618E	100
	17 - 19	INOX 1719E	100
	18 - 20	INOX 1820E	100

Precio por 100

Abrazaderas de 1 oreja acero tratado con anillo Inox

T5

	Ø min./máx. (mm)	Referencia	Emba.
	7,5 - 8,5	0708EG	100
	8 - 9,5	0809EG	100
	9 - 10,5	0910EG	100
	10 - 11,5	1011EG	100
	10,5 - 12,5	1012EG	100
	11,5 - 13,3	1113EG	100
	13 - 15,3	1315EG	100
	15 - 17,3	1517EG	100

Precio por 100

Abrazaderas de 1 oreja Inox

T5

	Ø min./máx. (mm)	Referencia	Emba.
	7,5 - 8,5	INOX 0708EG	100
	8,2 - 9,5	INOX 0809EG	100
	9 - 10,5	INOX 0910EG	100
	10 - 11,5	INOX 1011EG	100
	10,5 - 12,5	INOX 1012EG	100
	11,5 - 13,5	INOX 1113EG	100
	12,5 - 14,5	INOX 1314EG	100
	13 - 15,3	INOX 1315EG	100
	14 - 16,3	INOX 1416EG	100
	15 - 17,3	INOX 1517EG	100
	16 - 18,3	INOX 1618EG	100
	17 - 19,3	INOX 1719EG	100

Precio por 100

ABRAZADERAS DE 2 OREJAS

Abrazaderas de 2 orejas acero tratado

T5

	Ø min./máx. (mm)	Referencia	Emba.
	05 - 07	0507	100
	07 - 09	0709	100
	09 - 11	0911	100
	11 - 13	1113	100
	13 - 15	1315	100
	14 - 17	1517	100
	15 - 18	1518	100
	17 - 20	1720	100
	18 - 21	1821	100
	20 - 23	2023	100
	22 - 25	2225	100
	23 - 27	2327	100
	25 - 28	2528	100
	28 - 31	2731	100
	31 - 34	3134	100
	34 - 37	3437	100
	37 - 40	3740	50
	40 - 43	4043	50
	43 - 46	4346	50

Precio por 100 Abrazadera 2 orejas

Abrazaderas de 2 orejas doble acero tratado para emparejado de tubo

T5

	Ø min./máx. (mm)	Referencia	Emba.
	12-13	1213D	100
	14-15	1415D	100
	16-17	1617D	100
	18-19	1819D	100

Precio por 100 Embalaje : 100 unidades

Abrazaderas de 2 orejas acero inoxidable 304L

T5

	Ø min./máx. (mm)	Referencia	Emba.
	05 - 07	INOX 0507	100
	07 - 09	INOX 0709	100
	09 - 11	INOX 0911	100
	11 - 13	INOX 1113	100
	13 - 15	INOX 1315	100
	15 - 18	INOX 1518	100
	17 - 20	INOX 1720	100
	20 - 23	INOX 2023	100
	23 - 27	INOX 2327	100

Precio por 100 Abrazadera 2 orejas
Embalaje : 100 unidades
Material : Acero inoxidable 304L

Tenazas para montaje abrazaderas

T2

	Dénominación	Referencia	Emba.
	Tenazas de mordazas normales	SER 02	1
	Tenazas de mordazas laterales	SER 04	1

Caja surtida de abrazaderas de orejas

T2

	Composición	Referencia	Emba.
	Incluye un surtido de 213 abrazaderas de orejas tipo estándar PREVOST. Ref.0911 a ref 2327	BC 0927	1

ABRAZADERAS DE TORNILLO CON CINTA LLENA

Abrazaderas de tornillo estándar - Cinta de 9 mm

T5

Ø min./máx. (mm)	Referencia	Emba.
08 - 14	PBS9 814	100
11 - 17	PBS9 1117	100
13 - 20	PBS9 1320	100
15 - 24	PBS9 1524	50
19 - 28	PBS9 1928	50
22 - 32	PBS9 2232	50
26 - 38	PBS9 2638	25
32 - 44	PBS9 3244	25
38 - 50	PBS9 3850	25
44 - 56	PBS9 4456	25
50 - 65	PBS9 5065	25



Precio por 100

ABRAZADERAS DE TORNILLO CON CINTA LLENA - INOX

Serie inox 304 - Cinta de 12 mm

T5

Ø min./máx. (mm)	Referencia	Emba.
08 - 14	PBI9 814	100
11 - 17	PBI9 1117	100
13 - 20	PBI9 1320	100
15 - 24	PBI12 1524	50
19 - 28	PBI12 1928	50
22 - 32	PBI12 2232	50
26 - 38	PBI12 2638	25
32 - 44	PBI12 3244	25
38 - 50	PBI12 3850	25
44 - 56	PBI12 4456	25
50 - 65	PBI12 5065	25
58 - 75	PBI12 5875	25
68 - 85	PBI12 6885	1
77 - 95	PBI12 7795	1
87 - 112	PBI12 87112	1
104 - 138	PBI12 104138	1
130 - 165	PBI12 130165	1
150 - 180	PBI12 150180	1
175 - 205	PBI12 175205	1
200 - 231	PBI12 200231	1
226 - 256	PBI12 226256	1
251 - 282	PBI12 251282	1
277 - 307	PBI12 277307	1



Precio por 100

Abrazaderas de tornillo estándar - Cinta de 12 mm

T5

Ø min./máx. (mm)	Referencia	Emba.
15 - 24	PBS12 1524	50
19 - 28	PBS12 1928	50
22 - 32	PBS12 2232	50
26 - 38	PBS12 2638	25
32 - 44	PBS12 3244	25
38 - 50	PBS12 3850	25
44 - 56	PBS12 4456	25
50 - 65	PBS12 5065	25
58 - 75	PBS12 5875	25
68 - 85	PBS12 6885	1
77 - 95	PBS12 7795	1
87 - 112	PBS12 87112	1
104 - 138	PBS12 104138	1
130 - 165	PBS12 130165	1
150 - 180	PBS12 150180	1
175 - 205	PBS12 175205	1
200 - 231	PBS12 200231	1
226 - 256	PBS12 226256	1
251 - 282	PBS12 251282	1
277 - 307	PBS12 277307	1



Precio por 100

Serie inox 316 - Calidad marina

T5

Ø min./máx. (mm)	Referencia	Emba.
08 - 14	PBX9 814	100
11 - 17	PBX9 1117	100
13 - 20	PBX9 1320	100
15 - 24	PBX12 1524	50
19 - 28	PBX12 1928	50
22 - 32	PBX12 2232	50
26 - 38	PBX12 2638	25
32 - 44	PBX12 3244	25
38 - 50	PBX12 3850	25
44 - 56	PBX12 4456	25
50 - 65	PBX12 5065	25
58 - 75	PBX12 5875	25
68 - 85	PBX12 6885	1
77 - 95	PBX12 7795	1
87 - 112	PBX12 87112	1
104 - 138	PBX12 104138	1
130 - 165	PBX12 130165	1
150 - 180	PBX12 150180	1
175 - 205	PBX12 175205	1
200 - 231	PBX12 200231	1
226 - 256	PBX12 226256	1
251 - 282	PBX12 251282	1
277 - 307	PBX12 277307	1



Precio por 100

ABRAZADERAS DE TORNILLO CON CINTA PERFORADA

Abrazaderas de tornillo perforado - Cinta de 9 mm

T5

	Ø min./máx. (mm)	Referencia	Emba.
	10 - 16	PBJ9 1016	100
	14 - 24	PBJ9 1222	100
	18 - 28	PBJ9 1627	50
	24 - 36	PBJ9 2335	50
	25 - 45	PBJ9 3045	25
	32 - 52	PBJ9 3250	25
	47 - 67	PBJ9 5070	25
	77 - 97	PBJ9 7090	1

Precio por 100

ABRAZADERAS TIPO MINI Y TIPO MICRO

Serie Mini (acero electrogalvanizado) - Cinta de 9 mm

T5

	Ø min./máx. (mm)	Referencia	Emba.
	6 x 8	PBM 8	100
	7 x 9	PBM 9	100
	8 x 10	PBM 10	100
	9 x 11	PBM 11	100
	9 x 12	PBM 12	100
	10 x 13	PBM 13	100
	11 x 14	PBM 14	100
	12 x 15	PBM 15	100
	13 x 16	PBM 16	100
	14 x 17	PBM 17	100

Precio por 100

Serie Micro (acero electrogalvanizado) - Cinta de 5 mm

T5

	Ø min./máx. (mm)	Referencia	Emba.
	7 x 11	PBP 711	50
	11 x 19	PBP 1119	100

Precio por 100

ABRAZADERAS PESADAS

Abrazaderas pesadas

T5

	Ø min./máx. (mm)	Referencia	Emba.
	17 - 19	PBR 1719	1
	19 - 21	PBR 1921	1
	21 - 23	PBR 2123	1
	23 - 25	PBR 2325	1
	25 - 27	PBR 2527	1
	27 - 29	PBR 2729	1
	29 - 31	PBR 2931	1
	31 - 34	PBR 3134	1
	34 - 37	PBR 3437	1
	37 - 40	PBR 3740	1
	40 - 43	PBR 4043	1
	43 - 47	PBR 4347	1
	47 - 51	PBR 4751	1
	51 - 55	PBR 5155	1
	55 - 59	PBR 5559	1
	59 - 63	PBR 5963	1
	63 - 68	PBR 6368	1
	68 - 73	PBR 6873	1
	73 - 79	PBR 7379	1
	79 - 85	PBR 7985	1
	85 - 91	PBR 8591	1
	91 - 97	PBR 9197	1
	97 - 104	PBR 97104	1
	104 - 111	PBR 104111	1
	111 - 118	PBR 111118	1
	118 - 125	PBR 118125	1
	125 - 132	PBR 125132	1
	132 - 139	PBR 132139	1
	139 - 146	PBR 139146	1
	146 - 153	PBR 146153	1
	153 - 160	PBR 153160	1
	160 - 167	PBR 160167	1
167 - 174	PBR 167174	1	
174 - 187	PBR 174187	1	
187 - 200	PBR 187200	1	
200 - 213	PBR 200213	1	
213 - 226	PBR 213226	1	
226 - 239	PBR 226239	1	
239 - 252	PBR 239252	1	

Precio por 100

ABRAZADERAS CON VAINA DE CAUCHO

Abrazaderas con vaina de caucho - cinta de 12 mm

T5

Diámetro (mm)	Referencia	Emba.
6	PBC 126	50
8	PBC 128	50
10	PBC 1210	50
12	PBC 1212	50
15	PBC 1215	50
20	PBC 1220	50
22	PBC 1222	50
25	PBC 1225	50



Precio por 100

Abrazaderas con vaina de caucho - cinta de 15 mm

T5

Diámetro (mm)	Referencia	Emba.
6	PBC 156	50
8	PBC 158	50
10	PBC 1510	50
12	PBC 1512	50
15	PBC 1515	50
20	PBC 1520	50
22	PBC 1522	50
25	PBC 1525	50
28	PBC 1528	50
30	PBC 1530	50
32	PBC 1532	50
35	PBC 1535	50
38	PBC 1538	50
40	PBC 1540	50



Precio por 100

ABRAZADERAS DOBLE HILO GALVANIZADO

Abrazaderas doble hilo galvanizado

T5

Ø min./máx. (mm)	Referencia	Emba.
13 - 16	PF 1316	50
15 - 21	PF 1521	50
20 - 23	PF 2023	50
22 - 25	PF 2225	50
24 - 27	PF 2427	50
27 - 31	PF 2731	50
31 - 35	PF 3135	50
35 - 40	PF 3540	50
38 - 43	PF 3843	50
43 - 48	PF 4348	50
45 - 50	PF 4550	50
49 - 55	PF 4955	50
54 - 60	PF 5460	50
59 - 65	PF 5965	50
64 - 70	PF 6470	25
69 - 75	PF 6975	25
73 - 80	PF 7380	25
78 - 85	PF 7885	25



Precio por 100

ACCESORIOS ABRAZADERAS DE TORNILLO

Mostradores metálicos de abrazaderas de tornillo

T2

Composición	Referencia	Emba.
244 abrazaderas de tornillo : - 100 tipo mini PBM : 10 x PBM 8 / 10 x PBM 9 / 10 x PBM 10 / 10 x PBM 11 / 10 x PBM 12 / 10 x PBM 13 / 10 x PBM 14 / 10 x PBM 15 / 10 x PBM 16 / 10 x PBM 17	DEPANNE 244	1
- 144 tipo estándar PBS : 12 x PBS9 814 / 12 x PBS9 1117 / 12 x PBS9 1320 / 24 x PBS9 1524 / 12 x PBS9 1928 / 12 x PBS9 2232 / 12 x PBS9 2638 / 12 x PBS9 3244 / 12 x PBS9 3850 / 12 x PBS9 4456 / 12 x PBS9 506		
- 1 destornillador flexible : PB 3000		
400 abrazaderas de tornillo : - 100 tipo mini PBM : 10 x PBM 8 / 10 x PBM 9 / 10 x PBM 10 / 10 x PBM 11 / 10 x PBM 12 10 x PBM 13 / 10 x PBM 14 / 10 x PBM 15 / 10 x PBM 16 / 10 x PBM 17	DEPANNE 400	1
- 300 tipo estándar PBS : 25 x PBS9 814 / 25 x PBS9 1117 / 25 x PBS9 1320 / 50 x PBS9 1524 / 25 x PBS9 1928 / 25 x PBS9 2232 / 25 x PBS9 2638 / 25 x PBS9 3244 / 25 x PBS9 3850 / 25 x PBS9 4456 / 25 x PBS9 5065		
- 1 destornillador flexible : PB 3000		



ACCESORIOS ABRAZADERAS DE TORNILLO

Maletas surtidas

T2

	Composición	Referencia	Emba.
1. 	1. La maleta metálica incluye : 133 abrazaderas de tornillo : - 80 tipo mini PBM : 10 x PBM 8 20 x PBM 10 20 x PBM 12 10 x PBM 14 10 x PBM 16 10 x PBM 17 - 53 tipo estándar PBS : 10 x PBS9 1117 20 x PBS9 1320 6 x PBS9 1524 5 x PBS9 1928 4 x PBS9 2232 4 x PBS9 2638 4 x PBS9 3244	PRATIC 135	1
2. 	- 1 destornillador flexible : PB 3000		
3. 	2. La maleta azul incluye : - 270 abrazaderas de tornillo PBS : 50 x PBS9 814 50 x PBS9 1117 50 x PBS9 1320 25 x PBS12 1524 25 x PBS12 1928 20 x PBS12 2232 15 x PBS12 2632 15 x PBS12 3244 10 x PBS12 3850 10 x PBS12 4456	PRATIC 300	1
4. 	- 1 destornillador flexible : PBM 3000		
	3. Cofrecito polipropileno : 210 abrazaderas de tornillo con cinta perforada : 50 x PBJ9 1016 50 x PBJ9 1222 40 x PBJ9 1627 40 x PBJ9 2335 30 x PBJ9 3045	PBJ 210	1
	4. Maleta incluye : - 150 abrazaderas de tornillo con cinta llena (para tubos Ø ext. 8 a 32 mm) : 30 x PBS9 814 30 x PBS9 1117 30 x PBS9 1928 30 x PBS9 2232	PBS 150	1

Kit de apriete

T5

Envase (m)	Ancho de cinta (mm)	Número de cárter suministrados	Referencia	Emba.
3	12	6	PBK 123	1
5	12	6	PBK 125	1
25	12	6	PBK 1225	1
Conjunto incluye : Cinta perforada, cárter articulado				

ACCESORIOS ABRAZADERAS DE TORNILLO

Cárter articulado

T5

	Referencia	Emba.
Cantidad : 100 Ancho de cinta : 12 mm	PBK 12	100
		
<p>Precio por 100</p>		

Destornillador flexible

T2

Dénominación	Referencia	Emba.
Destornillador flexible para todas las abrazaderas de tornillo con cabezal hexagonal	PB 3000	1
		

PROTECTORES DE ABRAZADERA DE OREJAS

Protector de caucho para enchufe

T1

NUEVO	Para tubo Ø ext. (mm)	Referencia	Emba.
	14 a 17	ECP S11417	1
	17 a 20	ECP S11720	1
 <p>Permiten la unión 100% antirrayaduras entre el enchufe y el tubo, cubriendo la abrazadera de orejas</p>			

EQUILIBRADORES DE ALIMENTACIÓN CON TUBO EN ESPIRAL

Equilibradores con manguera espiral

T2

Salida de aire (BSPP)	Peso (de la herramienta) (kg)	Referencia	Emba.
G 1/4 M	0,2 a 0,5	SPI 1	1
G 1/4 F	0,7 a 2	SPI 3	1
G 3/8 F	2,5 a 5	SPI 5	1
G 3/8 F	6 a 10	SPI 7	1

EQUILIBRADORES CON CABLE DE HIERRO - SERIE BAL

Serie DP : Capacidad de 4 kg a 25 kg

T2

Carga Mín (kg)	Carga Máx. (kg)	Referencia	Emba.
4	7	BAL 4070DP	1
7	10	BAL 70100DP	1
10	14	BAL 100140DP	1
14	18	BAL 140180DP	1
18	22	BAL 180220DP	1
22	25	BAL 220250DP	1

- Tensión del muelle por moleta dentada
- Dispositivo de frenado que permite posicionar la carga a diferentes alturas
- Seguridad de bajadas brutales de cargas en caso de ruptura del resorte
- Suspensión del equilibrador por mosquetón de seguridad giratorio
- Provisto de cable de seguridad para fijación secundaria
- Cable de acero inox con guía especial de material antifricción
- Enrollamiento y desenrollamiento del cable en tambor cónico rotativo con cojinetes a bolas

EQUILIBRADORES CON CABLE DE HIERRO - SERIE BAL

Serie A : Capacidad de 0,4 kg a 3 kg

T2

Carga Mín (kg)	Carga Máx. (kg)	Referencia	Emba.
0,4	1	BAL 0410A	1
1	2	BAL 1020A	1
2	3	BAL 2030A	1

- Tensión del muelle por moleta dentada
- Fijación de la carga por mosquetón giratorio

Serie F : Capacidad de 25 kg a 105 kg

T2

Carga Mín (kg)	Carga Máx. (kg)	Referencia	Emba.
25	30	BAL 250300F	1
30	35	BAL 300350F	1
35	45	BAL 350450F	1
45	55	BAL 450550F	1
55	65	BAL 550650F	1
65	75	BAL 650750F	1
75	90	BAL 750900F	1
90	105	BAL 9001050F	1

- Tensión del muelle por moleta dentada
- Seguridad de bajadas brutales de cargas en caso de ruptura del resorte
- Suspensión del equilibrador por mosquetón de seguridad giratorio
- Enrollamiento y desenrollamiento del cable en tambor cónico rotativo con cojinetes a bolas

Serie B : Capacidad de 2 kg a 8 kg

T2

Carga Mín (kg)	Carga Máx. (kg)	Referencia	Emba.
2	4	BAL 2040B	1
4	6	BAL 4060B	1
6	8	BAL 6080B	1

- Tensión del muelle por moleta dentada
- Seguridad de desenrollamiento de cable por una guía antifricción
- Seguridad de bajadas brutales de cargas en caso de ruptura del muelle

Serie E : Alimentación directa por tubo : Capacidad de 0,4 kg a 2,5 kg

T2

Carga Mín (kg)	Carga Máx. (kg)	Referencia	Emba.
0,4	0,8	BAL 0408E	1
0,75	1,5	BAL 0715E	1
1,2	2,5	BAL 1225E	1

- Alimentación directa de la herramienta por tubo de poliuretano Ø 6 x 8 mm
- Tensión del muelle por moleta dentada
- Enchufe macho G 1/4 BSPP con tratamiento previo de teflón
- Presión máx. de uso : 8 bar a 20°C

Serie CP : Capacidad de 8 kg a 14 kg

T2

Carga Mín (kg)	Carga Máx. (kg)	Referencia	Emba.
8	10	BAL 80100CP	1
10	14	BAL 100120CP	1

- Tensión del muelle por moleta dentada
- Seguridad de desenrollamiento de cable por una guía antifricción
- Seguridad de bajadas brutales de cargas en caso de ruptura del resorte

Pistolas y herramientas neumáticas



Pistolas de soplado prevoS1	133 - 134
Pistolas 27102 y otras pistolas de soplado	134 - 136
Conjuntos de soplado	137 - 138
Herramientas neumáticas	138 - 150
Pistolas de pintura, de lavado, y pistolas pulverizadoras	150 - 155
Bombas neumáticas de grasa y aceite	156 - 158

PISTOLAS DE SOPLADO PREVO S1 - PERFIL ISO 6150 B

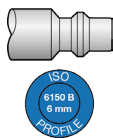

Pistola de soplado prevoS1 con boquilla metálica -
Modelo estándar

T2

	Fuerza de soplado (a 6 bar (g))	Consumo de aire (a 6 bar (Nm3/h))	Nivel de sonido (a 6 bar (dBA))	Referencia	Emba.
	390	20	89	IBG 06MTL	1
Enchufe prevo S1 vendido por separado : ISI 06					

Pistola de soplado prevoS1 con boquilla metálica
OSHA - Modelo estándar

T2

	Fuerza de soplado (a 6 bar (g))	Consumo de aire (a 6 bar (Nm3/h))	Nivel de sonido (a 6 bar (dBA))	Referencia	Emba.
	248	13	85	IBG 06MTLH	1
Enchufe prevo S1 vendido por separado : ISI 06					

Pistola de soplado prevoS1 con boquilla composite
poliamida OSHA - Modelo estándar

T2

	Fuerza de soplado (a 6 bar (g))	Consumo de aire (a 6 bar (Nm3/h))	Nivel de sonido (a 6 bar (dBA))	Referencia	Emba.
	260	13	87	IBG 060SH	1
Enchufe prevo S1 vendido por separado : ISI 06					

Pistola de soplado prevoS1 con boquilla composite
poliamida OSHA - Modelo pocket

T2

	Fuerza de soplado (a 6 bar (g))	Consumo de aire (a 6 bar (Nm3/h))	Nivel de sonido (a 6 bar (dBA))	Referencia	Emba.
	168	14	89	IPG 060SH	1
Enchufe prevo S1 vendido por separado : ISI 06					

PISTOLAS DE SOPLADO PREVO S1 - PERFIL EUROPEAN 7.4 MM



Pistola de soplado prevoS1 con boquilla metálica -
Modelo estándar

T2

	Fuerza de soplado (a 6 bar (g))	Consumo de aire (a 6 bar (Nm3/h))	Nivel de sonido (a 6 bar (dBA))	Referencia	Emba.
	390	20	89	EBG 07MTL	1
Enchufe prevo S1 vendido por separado : ESI 07					

Pistola de soplado prevoS1 con boquilla metálica
OSHA - Modelo estándar

T2

	Fuerza de soplado (a 6 bar (g))	Consumo de aire (a 6 bar (Nm3/h))	Nivel de sonido (a 6 bar (dBA))	Referencia	Emba.
	248	13	85	EBG 07MTLH	1
Enchufe prevo S1 vendido por separado : ESI 07					

Pistola de soplado prevoS1 con boquilla composite
poliamida OSHA - Modelo estándar

T2

	Fuerza de soplado (a 6 bar (g))	Consumo de aire (a 6 bar (Nm3/h))	Nivel de sonido (a 6 bar (dBA))	Referencia	Emba.
	260	13	87	EBG 070SH	1
Enchufe prevo S1 vendido por separado : ESI 07					

Pistola de soplado prevoS1 con boquilla composite
poliamida OSHA - Modelo pocket

T2

	Fuerza de soplado (a 6 bar (g))	Consumo de aire (a 6 bar (Nm3/h))	Nivel de sonido (a 6 bar (dBA))	Referencia	Emba.
	168	14	89	EPG 070SH	1
Enchufe prevo S1 vendido por separado : ESI 07					

PRODUCTOS ASOCIADOS



PREVO S1
ISI 06 - p 5



Prolongadores de tubo
con enchufes - p 120

PRODUCTOS ASOCIADOS



PREVO S1
ESI 07 - p 10



Prolongadores de tubo
con enchufes - p 120

PISTOLAS DE SOPLADO PREVO S1 - PERFIL ISO 6150 C



Pistola de soplado prevoS1 con boquilla metálica - Modelo estándar

T2

Fuerza de soplado (a 6 bar (g))	Consumo de aire (a 6 bar (Nm ³ /h))	Nivel de sonido (a 6 bar (dBA))	Referencia	Emba.
390	20	89	CBG 06MTL	1
Enchufe prevo S1 vendido por separado : CSI 06				

Pistola de soplado prevoS1 con boquilla composite poliamida OSHA - Modelo estándar

T2

Fuerza de soplado (a 6 bar (g))	Consumo de aire (a 6 bar (Nm ³ /h))	Nivel de sonido (a 6 bar (dBA))	Referencia	Emba.
260	13	87	CBG 06OSH	1
Enchufe prevo S1 vendido por separado : CSI 06				

Pistola de soplado prevoS1 con boquilla composite poliamida OSHA - Modelo pocket

T2

Fuerza de soplado (a 6 bar (g))	Consumo de aire (a 6 bar (Nm ³ /h))	Nivel de sonido (a 6 bar (dBA))	Referencia	Emba.
168	14	89	CPG 06OSH	1
Enchufe prevo S1 vendido por separado : CSI 06				

PRODUCTOS ASOCIADOS



PREVO S1
CSI 06 - p 15



Prolongadores de tubo con enchufes - p 120

ACCESORIOS PARA PISTOLAS DE SOPLADO

Soporte de fijación mural para pistolas de soplado prevoS1 y 27102

T2

Centros defijación (mm)	Equipado con	Referencia	Emba.
70	-	BG FIX	1
70	Fijación magnética	BG FIXM	1

PISTOLA DE SOPLADO 27102

Pistola de soplado con boquilla metálica

T2

Rosca hembra BSPP	Consumo de aire (a 6 bar (Nm ³ /h))	Nivel de sonido (a 6 bar (dBA))	Referencia	Emba.
G 1/4	23	83	27102 MTL	1
G 1/4	9	73	27102 MTLBP3	1
27102 MTLBP3 : Opción pistola de soplado con limitador de caudal. A 6 bar de entrada, el chorro de aire equivale al de una pistola de soplado estándar con una entrada a 3 bar				

Pistola de soplado con boquilla antirrayaduras

T2

Rosca hembra BSPP	Consumo de aire (a 6 bar (Nm ³ /h))	Nivel de sonido (a 6 bar (dbA))	Referencia	Emba.
G 1/4	15	84	27102 PRE	1
G 1/4	10	80	27102 PREBP3	1
27102 PREBP3 : Opción pistola de soplado con limitador de caudal. A 6 bar de entrada, el chorro de aire equivale al de una pistola de soplado estándar con una entrada a 3 bar.				

Pistola de soplado con boquilla silenciosa

T2

Rosca hembra BSPP	Consumo de aire (a 6 bar (Nm ³ /h))	Nivel de sonido (a 6 bar (dbA))	Referencia	Emba.
G 1/4	12	77	27102 SIL	1
Conforme a la reglamentación americana OSHA				

PISTOLA DE SOPLADO 27102

Pistola de soplado con pantalla de aire protectora

T2

Rosca hembra BSPP	Consumo de aire (a 6 bar (Nm ³ /h))	Nivel de sonido (a 6 bar (dBA))	Referencia	Emba.
G 1/4	27	82	27102 ECR	1
Nivel de sonido : 82 dB				

Pistola de soplado con boquilla OSHA con efecto Venturi

T2

Rosca hembra BSPP	Consumo de aire (a 6 bar (Nm ³ /h))	Nivel de sonido (a 6 bar (dBA))	Referencia	Emba.
G 1/4	13	90	27102 OSH	1
Conforme a la reglamentación americana OSHA				

Pistola con boquilla metálica de acero

T2

Rosca hembra BSPP	Consumo de aire (a 6 bar (Nm ³ /h))	Longitud acodada (mm)	Referencia	Emba.
G 1/4	15	330	27102 MB13	1
G 1/4	14,5	500	27102 MB20	1
G 1/4	9,4	1000	27102 MB400SH	1

Cuerpo de pistola de soplado adaptable

T2

Dénominación	Rosca BSPP	Longitud boquilla (mm)	Referencia	Emba.
Cuerpo de pistola de soplado para adaptar con diferentes boquillas	G 1/8 H		27102 F18	1
Boquilla larga de cobre deformable	G 1/8 M	1000	27102 BL10	1

PISTOLA DE SOPLADO 27102 EQUIPADO DE CONECTOR

Pistola con boquilla metálica

T2

Perfil	Paso (mm)	Consumo de aire (a 6 bar (Nm ³ /h))	Referencia	Emba.
ISO 6150 B	6	23	27102 MT6I	1
ISO 6150 C	6	23	27102 MT6C	1
European 7,4 mm	7,4	23	27102 MT7E	1

Pistola con boquilla recta antirrayaduras

T2

Perfil	Paso (mm)	Consumo de aire (a 6 bar (Nm ³ /h))	Referencia	Emba.
ISO 6150 B	6	15	27102 PR6I	1
ISO 6150 C	6	15	27102 PR6C	1
European 7,4 mm	7,4	15	27102 PR7E	1

Pistola con boquilla silenciosa

T2

Perfil	Paso (mm)	Consumo de aire (a 6 bar (Nm ³ /h))	Referencia	Emba.
ISO 6150 B	6	12	27102 SI6I	1
ISO 6150 C	6	12	27102 SI6C	1
European 7,4 mm	7,4	12	27102 SI7E	1

Pistola con pantalla de aire protectora

T2

Perfil	Paso (mm)	Consumo de aire (a 6 bar (Nm ³ /h))	Referencia	Emba.
ISO 6150 B	6	27	27102 EC6I	1
ISO 6150 C	6	27	27102 EC6C	1
European 7,4 mm	7,4	27	27102 EC7E	1

Pistola con boquilla OSHA con efecto Venturi

T2

Perfil	Paso (mm)	Consumo de aire (a 6 bar (Nm ³ /h))	Referencia	Emba.
ISO 6150 B	6	13	27102 OS6I	1
ISO 6150 C	6	13	27102 OS6C	1
European 7,4 mm	7,4	13	27102 OS7E	1

PISTOLAS DE SOPLADO STYL'AIR

Pistola de soplado metálica de seguridad

T2

Boquilla	Rosca hembra BSPP	Longitud boquilla (mm)	Referencia	Emba.
Equipada con boquilla con pantalla de aire	G 1/4	90	STL 101	1

Boquillas acodadas para STYL'AIR

T2

Rosca macho métrica	Referencia	Emba.
M10 x 100	STL 151	1
M10 x 100	STL 152	1
M10 x 100	STL 153	1

PISTOLA DE SOPLADO METALICA

Pistola de soplado - boquilla corta

T2

Boquilla	Rosca BSPP	Consumo de aire (a 6 bar (Nm ³ /h))	Referencia	Emba.
Boquilla corta	G 1/4 H	1,2	BGM 104	1
Boquilla corta de repuesto	G 1/4 M	-	BGM B104	1

Pistola de soplado - boquilla mediana L. 180mm

T2

Boquilla	Rosca BSPP	Consumo de aire (a 6 bar (Nm ³ /h))	Referencia	Emba.
Boquilla mediana	G 1/4 H	20,4	BGM 105	1
Boquilla de repuesto	G 1/4 M	-	BGM B105	1

PISTOLAS DE SOPLADO FORCE 3

Pistola de soplado con trinquete y conector ISO 6150 B

T2

Compatibilidad	Referencia	Emba.
ISI 06 - IRC 06 - PROLAC - PROXI	FORCE 3	1

Pistola de soplado extralarga L. 300 mm

T2

Boquilla	Rosca BSPP	Consumo de aire (a 6 bar (Nm ³ /h))	Referencia	Emba.
Extra-larga	G 1/4 H	20,4	BGM 106	1
Boquilla larga de re- puesto	G 1/4 M	-	BGM B106	1

Pistola de soplado rosca hembra

T2

Entrada rosca hembra BSPP	Referencia	Emba.
G 1/4	FORCE 3F14	1

Pistola de soplado especial "alto caudal"

T2

Boquilla	Rosca BSPP	Longitud boquilla (mm)	Referencia	Emba.
Boquilla Venturi	G 1/4 H	76	BGM 113	1
Boquilla Venturi de re- puesto	G 1/4 M	76	BGM B113	1

CONJUNTOS DE SOPLADO

Conjunto de soplado poliuretano

T2

	Referencia	Emba.
	Rosca macho BSPT : R 1/4 Long. : 2 m Equipado con : 1 pistola de soplado 27102 MTL 1 tubo en espiral de poliuretano PUS 52	HELICOL 6P 1
	Rosca macho BSPT : R 1/4 Long. : 4 m Equipado con : 1 pistola de soplado 27102 MTL 1 tubo en espiral de poliuretano PUS 54	HELICOL 7P 1

Conjunto de soplado con conexión fija

T2

	Referencia	Emba.
	Rosca macho BSPP : G 1/4 Long. : 5 m Equipado con : 1 pistola de soplado 27102 MTL 1 tubo en espiral de poliamida SPI 95	HELICOL 3 1

Conjunto de soplado con BGM 104, tubo espiral y enchufe rápido estándar

T2

	Referencia	Emba.
	Enchufe : IRC 06 Long. : 2 m Equipado con : 1 tubo en espiral de poliuretano PUS 52 1 enchufe IRC 06 y 2 conectores IRP 06 1 pistola de soplado BGM 104	HELICOL 9 1

Conjunto con pistola de soplado a deformación - Empalme fijo

T2

	Referencia	Emba.
	Rosca macho BSPP : G 1/4 Long. : 4 m Equipado con : 1 tubo en espiral de poliuretano 1 pistola de soplado antirrayaduras	HELICOL 4 1
Incluye : 1 tubo en espiral de poliuretano G 1/4 M 1 pistola de soplado antirrayaduras		

Conjunto con 27102 MTL, espiral, conector y enchufe de seguridad

T2

Ø int./ext. (mm)	Enchufe	Long. (máx.(m))	Referencia	Emba.
5 x 8	ESI 07	4	PUS 54BES	1
6,5 x 10	ESI 07	6	PUS 66BES	1
6,5 x 10	ESI 07	8	PUS 68BES	1
5 x 8	ISI 06	2	PUS 52BIS	1
5 x 8	ISI 06	4	PUS 54BIS	1
6,5 x 10	ISI 06	4	PUS 64BIS	1
6,5 x 10	ISI 06	6	PUS 66BIS	1
6,5 x 10	ISI 06	8	PUS 68BIS	1
Incluye : - 1 tubo en espiral de poliuretano - 1 enchufe prevo S1 - 2 conectores - 1 pistola de soplado 27102 MTL				

ASPIRADOR NEUMÁTICO "ASPIVENT"

Aspirador Neumática Aluminio « ASPIVENT »

T2

NUEVO	Entrada rosca hembra BSPP	Presión máx de uso (bar)	Consumo de aire (l/min)	Referencia	Emba.
	G 1/4	6,2	420	ASVM 1	1
- Pistola de limpieza por aspiración - Tubo de evacuación Ø 30 mm – longitud 1,25 m - Bolsa de recuperación - Prolongador de extension longitud 17 cm - Boquilla larga - Accesorio de cepillado - 2 x Abrazaderas					



Accesorios

T2

NUEVO	Composición	Referencia	Emba.
	Accesorios ASVM1	ASVM KIT	1
- Tubo de evacuación Ø 30 mm – longitud 1,25 m - Bolsa de recuperación - Prolongador de extension longitud 17 cm - Boquilla larga - Accesorio de cepillado - 2 x Abrazaderas			



PISTOLAS DE INFLADO

Pistola de inflado

T2

Rosca hembra BSPP	Graduación (bar)	Referencia	Emba.
G 1/4	0 a 12	27151	1
Aplicación : Automóvil, moto			



Pistola de inflado, modelo Eurodairu

T2

Entrada de aire	Graduación (bar)	Referencia	Emba.
G 1/4 H	0,7 a 11	27101	1
Conector IRP 06 - ISO 6150 B	0,7 a 11	27101I	1
Los manómetros pertenecen a un tipo de instrumentos de medición que está regulado por : La directiva europea 86/217CE - El decreto 88/78 - La norma AFNOR EN12645.			



Pistola de inflado, modelo Mast'air

T2

Entrada de aire	Graduación (bar)	Referencia	Emba.
G 1/4	0,7 a 12	27201	1
Conformidad con la CE Pistola de inflado con teclas - y + Automóvil, moto, camiones de carga			



Piezas sueltas

T2

Dénominación	Conexión	Long. (m)	Referencia	Emba.
Tubo para pistolas de inflado 27201	Macho Pas Michelin	1,50	7101T	1
Tubo para pistolas de inflado 27101	Hembra Pas Michelin	1,50	7200T	1
Conector para conexión válvula	-	-	101V	1



HERRAMIENTAS DE APRIETE LLAVES DE TRINQUETE Y LLAVES DE IMPACTO

Llave de impacto composite - Doble martillo - Nueva generación

T3

Cuadrado conductor	Par de aflojamiento máx. (Nm)	Velocidad de rotación (rpm)	Referencia	Emba.
3/8"	407	13500	TIW C380645	1
1/2"	1085	8000	TIW C121150	1
3/4"	1763	6000	TIW C341630	1



Llave de impacto composite con eje extensible - Doble martillo - Nueva generación

T3

Cuadrado conductor	Par de aflojamiento máx. (Nm)	Velocidad de rotación (rpm)	Referencia	Emba.
1/2"	1085	8000	TIW C121150R	1
3/4"	1763	6000	TIW C341630R	1



Llave de impacto composite - Doble martillo - Nueva generación - En maletín

T3

Cuadrado conductor	Par de aflojamiento máx. (Nm)	Velocidad de rotación (rpm)	Referencia	Emba.
1/2"	1085	8000	TIW C121150K	1
Entregada en un maletín con los accesorios adicionales siguientes : 10 casquillos 1/2" (10, 12, 14, 17, 19, 21, 22, 23, 24, 27 mm) 1 alargador de 3" 1 miniengrasador				



Llave de impacto composite - Doble martillo - Nueva generación - En maletín

T3

Cuadrado conductor	Par de aflojamiento máx. (Nm)	Velocidad de rotación (rpm)	Referencia	Emba.
3/4"	1763	6000	TIW C341630K	1
Entregada en un maletín con : 5 puntas (24, 27, 30, 32, 33 mm) 1 mini-lubricador				



HERRAMIENTAS DE APRIETE LLAVES DE TRINQUETE Y LLAVES DE IMPACTO

Llave de impacto composite con eje extensible -
Doble martillo - Nueva generación - En maletín

T3

Cuadrado conductor	Par de aflojamiento máx. (Nm)	Velocidad de rotación (rpm)	Referencia	Emba.
1/2"	1085	8000	TIW C121150RK	1
Entregada en maletín con : 10 casquillos (10, 12, 14, 17, 19, 21, 22, 23, 24, 27 mm) 1 alargador de 3" 1 miniengrasador				



Llave de impacto composite con eje extensible -
Doble martillo - Nueva generación - En maletín

T3

Cuadrado conductor	Par de aflojamiento máx. (Nm)	Velocidad de rotación (rpm)	Referencia	Emba.
3/4"	1763	6000	TIW C341630RK	1
Entregada en un maletín con : 5 puntas (24, 27, 30, 32, 33 mm) 1 mini-lubricador G 1/4				



Llave de impacto compacta - Martillo sencillo

T3

Cuadrado conductor	Par de aflojamiento máx. (Nm)	Velocidad de rotación (rpm)	Referencia	Emba.
1/2"	678	10 000	TIW K120680	1



Llave de impacto 1/2" compacta - Martillo sencillo -
En maletín

T3

Cuadrado conductor	Par de aflojamiento máx. (Nm)	Velocidad de rotación (rpm)	Referencia	Emba.
1/2"	678	10 000	TIW K120680K	1
Entregada en maletín con : 6 casquillos 1/2" (13, 17, 19, 21, 22, 24 mm) 1 miniengrasador				



Llave de impacto material composite - Doble martillo

T3

Cuadrado conductor	Par de aflojamiento máx. (Nm)	Velocidad de rotación (rpm)	Referencia	Emba.
1/2"	949	8000	TIW C120950	1



HERRAMIENTAS DE APRIETE LLAVES DE TRINQUETE Y LLAVES DE IMPACTO

Llave de impacto composite con par limitado -
Doble martillo

T3

Cuadrado conductor	Velocidad de rotación (rpm)	Par de apriete/aflojamiento máx. (Nm)	Referencia	Emba.
1/2"	R 8000 F 2500	R 814 F 108	TIW C12L815	1



Llave de impacto - material composite -
Doble martillo - en maletín

T3

Cuadrado conductor	Par de aflojamiento máx. (Nm)	Velocidad de rotación (rpm)	Referencia	Emba.
1/2"	949	8000	TIW C120950K	1
Entregada en maletín con : 10 casquillos 1/2" (10, 12, 14, 17, 19, 21, 22, 23, 24, 27 mm) 1 alargador de 3" 1 miniengrasador				



Llave de impacto con par limitado -
material composite - Doble martillo - en maletín

T3

Cuadrado conductor	Velocidad de rotación (rpm)	Par de apriete/aflojamiento máx. (Nm)	Referencia	Emba.
1/2"	R 8000 F 2500	R 814 F 108	TIW C12L815K	1
Entregada en maletín con : 10 casquillos 1/2" (10, 12, 14, 17, 19, 21, 22, 23, 24, 27 mm) 1 alargador de 3" 1 miniengrasador				



Llave de impacto composite en ángulo - Martillo sencillo

T3

Cuadrado conductor	Par de aflojamiento máx. (Nm)	Velocidad de rotación (rpm)	Referencia	Emba.
1/2"	244	7000	TIW C120270	1



HERRAMIENTAS DE APRIETE LLAVES DE TRINQUETE Y LLAVES DE IMPACTO

Llave de impacto aluminio - Doble martillo

T3

	Cuadrado conductor	Par de aflojamiento máx. (Nm)	Velocidad de rotación (rpm)	Referencia	Emba.
	1/2"	949	7000	TIW A120950	1
	3/4"	1492	5500	TIW A341490	1

Llave de impacto aluminio - Nueva generación

T3

	Cuadrado conductor	Par de aflojamiento máx. (Nm)	Velocidad de rotación (rpm)	Referencia	Emba.
	1"	2441	5000	TIW A012440	1

Llave de impacto recta - Doble martillo

T3

	Cuadrado conductor	Par de aflojamiento máx. (Nm)	Velocidad de rotación (rpm)	Referencia	Emba.
	1"	2712	5000	TIW A012710	1

Llave de trinquete

T3

	Cuadrado conductor	Par de aflojamiento máx. (Nm)	Velocidad de rotación (rpm)	Referencia	Emba.
	1/4"	27	200	TRW 14027	1
	3/8"	68	160	TRW 38070	1
	1/2"	70	160	TRW 12070	1
	1/2"	163	600	TRW 12160	1
TRW 12160 : Martillo simple - Alto rendimiento					

Llave de trinquete - En maletín

T3

NUEVO 	Cuadrado conductor	Par de aflojamiento máx. (Nm)	Velocidad de rotación (rpm)	Referencia	Emba.
	1/4"	27	200	TRW 14027K	1
Entregada en un maletín con los accesorios adicionales siguientes : 5 casquillos (8, 9, 10, 11, 12 mm) 3 alargadores (37, 50, 100 mm)					

ATORNILLAMIENTO

Atornillador recto 1/4"

T3

	Mandril	Par de apriete (Nm)	Velocidad de rotación (rpm)	Referencia	Emba.
	6,35 mm Hex. 1/4"	5 - 13	1800	TSD S1800I	1

Pistola atornilladora

T3

	Mandril	Par de apriete (Nm)	Velocidad de rotación (rpm)	Referencia	Emba.
	6,35 mm Hex. 1/4"	5 - 16	800	TSD P0800I	1
	6,35 mm Hex. 1/4"	5 - 14	1800	TSD P1800I	1

Atornillador recto especial industria

T3

	Mandril	Par de apriete (Nm)	Velocidad de rotación (rpm)	Referencia	Emba.
	4 mm - 5/32"	0,4 - 2	1000	TSD S1000E	1
Mecanismo de presión Desacoplamiento automático					

Pistola atornilladora especial industria

T3

	Mandril	Par de apriete (Nm)	Velocidad de rotación (rpm)	Referencia	Emba.
	6,35 mm Hex 1/4"	1 - 6	1700	TSD P1700E	1
Desacoplamiento automático					

LIJADO

Lijadora orbital 2 manos

T3

Descentrado (mm)	Diámetro (plataforma)	Velocidad de rotación (rpm)	Referencia	Emba.
2,5	152 mm - 6"	10 000	TOS 15025	1
5	152 mm - 6"	10 000	TOS 15050	1



Pistola lijadora orbital 75 mm

T3

Descentrado (mm)	Diámetro (plataforma)	Velocidad de rotación (rpm)	Referencia	Emba.
3	75 mm - 3"	16 000	TPS E16000	1



Pistola lijadora orbital 50 y 75 mm - En maletín

T3

Diámetro (plataforma)	Velocidad de rotación (rpm)	Referencia	Emba.
50-75 mm 2" - 3"	16000	TPS E16000K	1

Entregada en maletín con :

- 1 disco de velcro 3"
- 1 disco de velcro 2"
- 10 discos abrasivos 3" grano 600
- 10 discos abrasivos 3" grano 400
- 10 discos abrasivos 3" grano 320
- 10 discos abrasivos 3" grano 600
- 10 discos abrasivos 3" grano 400
- 10 discos abrasivos 3" grano 320



PISTOLA LIJADORA Y PISTOLA PULIDORA

Pistola lijadora 75 mm

T3

Diámetro (disco)	Potencia (CV - W)	Velocidad de rotación (rpm)	Referencia	Emba.
75 mm - 3"	0,45 CV - 330 W	16 000	TPS 16000	1



Pistola lijadora orbital 75 mm - En maletín

T3

Diámetro (plataforma)	Potencia (CV)	Velocidad de rotación (rpm)	Referencia	Emba.
75mm - 3"	0,45 CV - 330 W	16 000	TPS 16000K	1

Entregada en maletín con :

- 1 disco de 3"
- 10 discos abrasivos grano 60
- 10 discos abrasivos grano 80
- 10 discos abrasivos grano 120
- 1 almohadilla de preparación
- 1 disco de decapado
- 1 llave



Pistola pulidora 75 mm

T3

Diámetro (de la plataforma)	Potencia (CV - W)	Velocidad de rotación (rpm)	Referencia	Emba.
75 mm - 3"	0,45 CV - 330 W	2100	TPS 2100	1



Pistola pulidora 75 mm - En maletín

T3

Diámetro (plataforma)	Potencia (CV - W)	Velocidad de rotación (rpm)	Referencia	Emba.
75 mm - 3"	0,45 CV - 330 W	2100	TPS 2100K	1

Entregada en maletín con :

- 1 eje hembra
- 1 disco Velcro 3"
- 1 almohadilla de espuma amarilla 3-1/2"
- 1 almohadilla de espuma blanca 3-1/2"
- 1 Almohadilla de lana 3-1/2"
- 1 llave



LIJADO DE CINTA

Lijadora orbital 2 manos

T3

	Dimensiones (plataforma (mm))	Potencia (CV - W)	Velocidad de rotación (rpm)	Referencia	Emba.
	10 x 330	0,5 CV - 370 W	16 000	TBS 10330	1
	20 x 520	0,5 CV - 370 W	16 000	TBS 20520	1

DEBASTADO

Amoladora recta

T3

	Ø de la pinza (mm)	Potencia (CV - W)	Velocidad de rotación (rpm)	Referencia	Emba.
	3 & 6	0,5 CV - 370 W	22 000	TDG S22000	1

Amoladora recta - En maletín

T3

	Ø de la pinza (mm)	Potencia (CV - W)	Velocidad de rotación (rpm)	Referencia	Emba.
	3 & 6	0,5 CV - 370 W	22 000	TDG S22000K	1
	Entregada en maletín con : 1 pinza Ø 3 mm 1 pinza Ø 6 mm 10 recambios 2 llaves				

Amoladora recta

T3

	Ø de la pinza (mm)	Potencia (CV - W)	Velocidad de rotación (rpm)	Referencia	Emba.
	3 & 6	0,5 CV - 370 W	4000	TDG S04000	1

DEBASTADO

Amoladora compuesta recta

T3

	Ø de la pinza (mm)	Potencia (CV - W)	Velocidad de rotación (rpm)	Referencia	Emba.
	3 & 6	0,5 CV - 370 W	18 000	TDG A18000	1

Amoladora compuesta recta - En maletín

T3

	Ø de la pinza (mm)	Potencia (CV - W)	Velocidad de rotación (rpm)	Referencia	Emba.
	3 & 6	0,5 CV - 370 W	18 000	TDG A18000K	1
	Entregada en maletín con : 1 pinza Ø 3 mm 1 pinza Ø 6 mm 10 recambios 2 llaves				

Amoladora 115°

T3

	Ø de la pinza (mm)	Potencia (CV - W)	Velocidad de rotación (rpm)	Referencia	Emba.
	3 & 6	0,5 CV - 370 W	18 000	TDG B18000	1

Amoladora recta larga

T3

	Ø de la pinza (mm)	Potencia (CV - W)	Velocidad de rotación (rpm)	Referencia	Emba.
	3 & 6	0,5 CV - 370 W	22 000	TDG S22000R	1

Mini-amoladora

T3

	Ø de la pinza (mm)	Potencia (CV - W)	Velocidad de rotación (rpm)	Referencia	Emba.
	3	0,5 CV - 370 W	60 000	TDG M60000	1

PULIDO

Amoladora de ángulo

T3

	Diámetro (de la plataforma (mm))	Velocidad de rotación (rpm)	Referencia	Emba.
	125 mm 5"	11 000	TAG 125	1
	178 mm 7"	6000	TAG 178	1

PERFORADO

Taladro recto

T3

	Diámetro (Mandril (mm))	Potencia (CV - W)	Velocidad de rotación (rpm)	Referencia	Emba.
	10 mm 3/8"	0,5 CV - 330 W	2500	TAD S382500	1

Taladro neumático

T3

	Diámetro (Mandril (mm))	Potencia (CV - W)	Velocidad de rotación (rpm)	Referencia	Emba.
	10 mm 3/8"	0,45 CV - 330 W	W1 : 1000 W2 : 2000	TAD P382000	1
	13 mm 1/2"	0,45 CV - 330 W	W1 : 450 W2 : 800	TAD P380800	1

TALADROS

Martillo taladro con acoplamiento hexagonal - En maletín

T3

	Mandril (mm)	Cadencia de golpe (bpm)	Recorrido del pistón (mm)	Referencia	Emba.
	Hex. 10,2	3000	60	TAH 0663000K	1
	Entregado en maletín con : 5 brocas hexagonales de 175 mm				

Martillo taladro con sistema de amortiguación de vibraciones

T3

	Mandril (mm)	Cadencia de golpe (bpm)	Recorrido del pistón (mm)	Referencia	Emba.
	Hex. 10,2	3000	70	TAH 0703000VD	1
	Hex. 10,2	2100	95	TAH 0952100VD	1

Martillo taladro

T3

	Mandril (mm)	Cadencia de golpe (bpm)	Recorrido del pistón (mm)	Referencia	Emba.
	Hex. 14,75	1900	115	TAH 1151900	1

PISTOLA DECAPADORA

Pistola decapadora 19 agujas

T3

	Cadencia de golpe (bpm)	Recorrido del pistón (mm)	Referencia	Emba.
	3700	33	TSP 0333700	1
	Agujas Ø 3mm, longitud 180 mm			

Pistola decapadora

T3

	Cadencia de golpe (bpm)	Recorrido del pistón (mm)	Referencia	Emba.
	4200	26	TSP 0264300	1
	Agujas Ø 3mm, longitud 180 mm			

HERRAMIENTAS DE CORTE

Sierra de calar de producción

T3

	Cadencia de corte (bpm)	Referencia	Emba.
	5000	TCS 05000	1
	Carrera hoja : 10 mm Espesor de corte : Acero : 2 mm Alu : 3 mm		

Cizalla de pistola

T3

	Potencia (CV - W)	Velocidad de rotación (rpm)	Referencia	Emba.
	0,45 CV - 330 W	2500	TCS 02500	1
	Espesor de corte : Acero : 1,2 mm Alu : 1,4 mm Ancho de corte : 5,5 mm			

Mini tronzadora

T3

	Diámetro (de disco)	Potencia (CV - W)	Velocidad de rotación (rpm)	Referencia	Emba.
	7,5mm 3"	0,5 CV - 370 W	20 000	TCS 20000	1

Mordiscadora

T3

	Cadencia de golpe (bpm)	Referencia	Emba.
	3500	TCS 03500	1
	Ø punzón de corte : 4 mm Espesor de corte : Acero : 1,4 mm Alu : 1,6 mm		

HERRAMIENTAS ESPECÍFICAS

Remachadora hidroneumática con sistema de aspiración

T3

	Diámetro (Remaches (mm))	Recorrido del pistón (mm)	Fuerza de tracción (kg)	Referencia	Emba.
	2,4 - 4,8	14	1219	TAR 481220	1
	2,4 - 6,4	19	1894	TAR 641895	1
Remachadora para colocación de remaches					

Herramienta para perforar y pulir Ø 5 mm

T3

	Diámetro (del punzón (mm))	Potencia (CV - W)	Referencia	Emba.
	5	0,5 CV - 370 W	TPF 5	1
	Espesor de chapa máx. : 1,6 mm			

Pistola para cartuchos

T3

	Dimensiones (del tubo (mm))	Capacidad (cartucho - ml)	Referencia	Emba.
	50 x 236	310 - 400	TCG CB400	1

Pistola lubricadora

T3

	Capacidad (cc)	Referencia	Emba.
	400	TCG GR400	1

Herramienta de limpieza

T3

	Dimensiones (de disco)	Velocidad de rotación (rpm)	Potencia (CV - W)	Referencia	Emba.
	3" 75 mm	4000	0,5 CV - 370 W	TDG P04000	1

HERRAMIENTAS ESPECÍFICAS

Cepilladora neumática

T3

	Consumo de aire (l/min)	Potencia (CV - W)	Velocidad de rotación (rpm)	Referencia	Emba.
	110	0,5 CV - 370 W	3500	TMB 3500	1

Cepilladora neumática - En maletín

T3

	Potencia (CV - W)	Velocidad de rotación (rpm)	Peso (kg)	Referencia	Emba.
	0,0,5 CV - 370 W	3500	1	TMB 3500K	1
Características idénticas a la cepilladora TMB 3500 Entregada en maletín con : 1 Kit de fijación 3 Gomas 3 Cepillos de limpieza 3 Cepillos de decapado 1 Conector giratorio					

Cuchillo limpiaparabrisas

T3

	Potencia (CV - W)	Cadencia de corte (bpm)	Referencia	Emba.
	0,5 CV - 370 W	20000	TWK 20000	1

Lápiz grabador

T3

	Potencia (CV - W)	Velocidad de rotación (rpm)	Rosca hembra BSPT	Referencia	Emba.
	0,5 CV - 370 W	13 000	R 1/4	TES 34000	1

ACCESORIOS PARA LLAVES DE TRINQUETE Y LLAVES DE IMPACTO

9 manguitos 1/4"

T3

NUEVO	Compatibilidad	Referencia	Emba.
	TRW 14027	TIW 9S14	1
Manguitos tamaño : 7, 8, 9, 10, 11, 12, 13, 14, 15 mm			

Mini engrasador

T3

NUEVO	Capacidad (ml)	Referencia	Emba.
	80	TIW OILER	1

8 manguitos 3/8"

T3

	Compatibilidad	Referencia	Emba.
	TRW 38070 TIW C380645	TIW 8S38	1
Manguitos tamaño : 8, 10, 11, 13, 14, 16, 17, 19 mm			

3 manguitos 1/2"

T3

	Compatibilidad	Referencia	Emba.
	TIW C12L815K TIW C120270 TIW C120950 TIW C121150 TIW C 121150R TIW K120680 TIW A120950 TRW 12070 TRW 12160	TIW 3S12	1
Manguitos tamaño : 17x85 / 19x85 / 21x85			

ACCESORIOS PARA LLAVES DE TRINQUETE Y LLAVES DE IMPACTO

14 manguitos 1/2"

T3

Compatibilidad	Referencia	Emba.
TIW C12L815	TIW 14S12	1
TIW C120270		
TIW C120950		
TIW C121150		
TIW C121150R		
TIW K120680		
TIW A120950		
TRW 12070		
TRW 12160		
Manguitos tamaño : 10, 11, 13, 14, 15, 16, 17, 19, 20, 21, 22, 24, 27, 30 mm		

8 manguitos 3/4"

T3

Compatibilidad	Referencia	Emba.
TIW A341490	TIW 8S34	1
TIW C341630		
TIW C341630R		
Manguitos tamaño : 26, 27, 29, 30, 32, 35, 36, 38 mm		

8 manguitos 1"

T3

Compatibilidad	Referencia	Emba.
TIW A012440	TIW 8S01	1
TIW A012710		
Manguitos tamaño : 27, 30, 32, 33, 35, 36, 38, 41 mm		

Portaherramientas magnetico

T3

Compatibilidad	Referencia	Emba.
TIW A120950	TMH 15	1
TIW A341490		
TIW C12L85		
TIW C120270		
TIW C120950		
TIW C121150		
TIW C121150R		
TIW C341630		
TIW C341630R		
TIW C380645		
TIW K120680		
Peso max. : 15 kg		

ACCESORIOS PARA LIJADORAS, AMOLADORAS, PULIDORAS

Plataforma velcro para Lijado 2" y 3"

T3

Compatibilidad	Diámetro	Referencia	Emba.
TPS E16000 TPS 2100	2"	TPS VEL2	1
TPS E16000 TPS 2100	3"		
			

Filtro blanco 3" para pulidora 75 mm

T3

Compatibilidad	Diámetro	Referencia	Emba.
TPS 2100	3"	TPS WOOL	1
			

Espuma para pulidora 75 mm

T3

Compatibilidad	Diámetro	Referencia	Emba.
TPS 2100	3,5"	TPS WSPONGE	1
TPS 2100	3,5"	TPS YSPONGE	1
			

Plataforma para lijadora orbital Ø 152 mm

T3

Compatibilidad	Diámetro (mm)	Número de agujeros	Referencia	Emba.
TOS 15025 TOS 15050	152	6	TOS PAD22	1
TOS 15025 TOS 15050	152	15		
				

Bolsa de recogida para lijadora orbital Ø 152 mm

T3

Compatibilidad	Diámetro (mm)	Referencia	Emba.
TOS 15025 TOS 15050	152	TOS BAGHOSE	1
			

ACCESORIOS PARA LIJADORAS, AMOLADORAS, PULIDORAS

Llave de montaje

T3

Compatibilidad	Dimensiones (mm)	Referencia	Emba.
TOS 15025 TOS 15050	22	TOS KEY22	1



Kit de 30 discos abrasivos

T3

Compatibilidad	Referencia	Emba.
Compatibilidad : TPS E16000 TPS 2100 Diámetro : 3" Composición : 10 x 320 10 x 400 10 x 600 Grano	TPS KIT3X30	1



5 cintas 10 mm x 330 mm para lijadora de cinta

T3

Compatibilidad	Dimensiones (mm)	Grano	Referencia	Emba.
TBS 10330	10 x 330	80	TBS 10330K80	1
TBS 10330	10 x 330	100	TBS 10330K100	1
TBS 10330	10 x 330	120	TBS 10330K120	1



5 cintas 20 mm x 520 mm para lijadora de cinta

T3

Compatibilidad	Dimensiones (mm)	Grano	Referencia	Emba.
TBS 20520	20 x 520	80	TBS 20520K80	1
TBS 20520	20 x 520	100	TBS 20520K100	1

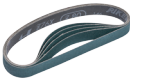

ACCESORIOS PARA AMOLADORA

Conjunto de 10 recambios

T3

Compatibilidad	Referencia	Emba.
TDG A18000 TDG B18000 TDG M60000 TDG S04000 TDG S22000 TDG S22000R	TDG KIT10	1



Disco para herramienta de limpieza

T3

Compatibilidad	Rosca	Referencia	Emba.
TDG P04000	5/16"	TDG KIT88	1



Tubo de escape reductora del nivel sonoro

T3

Compatibilidad	Referencia	Emba.
TCS 03500 TCS 05000 TDG A18000 TDG B18000 TDG P04000 TDG S04000 TDG S22000 TDG S22000R TWK 20000	TDG HOSE	1
Reductora del nivel sonoro : 5 dB(A)		



ACCESORIOS PARA MARTILO TALADRO

Muelle para martillo taladro 10,2 mm

T3

Compatibilidad	Diámetro (mm)	Referencia	Emba.
TAH 0663000K	10,2 mm	TAH COIL1	1



Mandril para martillo taladro 10,2 mm

T3

Compatibilidad	Diámetro (mm)	Referencia	Emba.
TAH 0663000K TAH 0703000VD TAH 0952100VD	10,2 mm	TAH QCR1	1



Brocas hexagonales para mandril 14,75 mm

T3

Diámetro (mm)	Long. (m)	Referencia	Emba.
14,75 mm	260	TAH CHIS1	1



Kit de 5 brocas hexagonales para mandril 10,2 mm

T3

Compatibilidad :	Referencia	Emba.
TAH 0663000K TAH 0703000VD TAH 0952100VD Diámetro : 10,2 mm Long. : 175 mm	TAH CHIS5B	1



ACCESORIOS PARA PISTOLA DECAPADORA

Juego de agujas para pistola decapadora

T3

Compatibilidad	Cantidad	Diámetro (mm)	Referencia	Emba.
TSP 0333700	19	3	TSP 19X3	1
TSP 0264300	12	3	TSP 12X3	1
TSP 0333700	29	2	TSP 29X2	1
TSP 0264300	27	2	TSP 27X2	1



Guarda-agujas para pistola decapadora

T3

Diámetro (mm)	Referencia	Emba.
2	TSP 0333700NH2	1
3	TSP 0333700NH3	1
2	TSP 0264300NH2	1
3	TSP 0264300NH3	1



ACCESORIOS PARA HERRAMIENTAS DE CORTE

Juego de 5 hojas para sierra sable

T3

Cantidad (dientes/cm)	Aplicaciones	Referencia	Emba.
6	acero	TCS 518	1
13	aluminio, cobre	TCS 524	1
16	composite, madera	TCS 532	1



Kit de mascado

T3

Compatibilidad	Referencia	Emba.
TCS 03500	TCS KIT	1



Tubo de escape reductora del nivel sonoro

T3

Compatibilidad	Referencia	Emba.
TCS 03500 TCS 05000 TDG A18000 TDG B18000 TDG P04000 TDG S04000 TDG S22000 TDG S22000R TWK 20000	TDG HOSE	1
Reductora del nivel sonoro : 5 dB(A)		



ACCESORIOS PARA HERRAMIENTAS ESPECÍFICAS

Kit de fijación del accesorios de cepilladora

T3

Compatibilidad	Referencia	Emba.
TMB 3500	TMB KITH	1



Cepillo de decapado

T3

Compatibilidad	Espesor (mm)	Diámetro	Referencia	Emba.
TMB 3500	23	4"	TMB KITB	1



Goma

T3

Compatibilidad	Espesor (mm)	Diámetro	Referencia	Emba.
TMB 3500	25	4"	TMB KITE	1



Cepillo de limpieza

T3

Compatibilidad	Espesor (mm)	Diámetro	Referencia	Emba.
TMB 3500	25	4"	TMB KITC	1



ACCESORIOS PARA CUCHILLO LIMPIAPARABRISAS

Cuchillo recto dentado

T3

Long. (mm)	Tipo	Referencia	Emba.
57	(4) N°8E	TWK 8E57	1
90	(4) N°8E	TWK 8E90	1
8	(3) N°8F	TWK 8F8	1
35	(6) N°8G	TWK 8G35	1
30	(2) N°8H	TWK 8H30	1
24	(8) N°8J	TWK 8J24	1
18	(7) N°8K	TWK 8K18R	1
36	(7) N°8K	TWK 8K36R	1
63	(7) N°8K	TWK 8K63R	1
90	(7) N°8K	TWK 8K90R	1
35	(1) N° 8B	TWK 8B35	1
35	(5) N° 8C	TWK 8C35	1

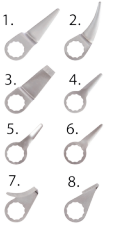

Tubo de escape reductora del nivel sonoro

T3

Compatibilidad	Referencia	Emba.
TCS 03500 TCS 05000 TDG A18000 TDG B18000 TDG P04000 TDG S04000 TDG S22000 TDG S22000R TWK 20000	TDG HOSE	1



Reductora del nivel sonoro : 5 dB(A)

ENCHUFES DE 2 DIRECCIONES

Enchufes de 2 direcciones con regulador para herramientas neumáticas

T2

Dénominación	Referencia	Emba.
Enchufe de 2 direcciones 360° con regulador y manómetro 0 a 10 bar	OP BDMR	1
Enchufe de 2 direcciones 360° con regulador	OP BDR	1



- Permite conservar el tubo recto, y sin forzarlo.
- Mejora la manipulación y la utilización de las herramientas neumáticas.
- Entrada : G 1/4 H
- Salida : R 1/4 M

Enchufes de 2 direcciones para herramientas neumáticas

T2

Dénominación	Referencia	Emba.
Enchufe de 2 direcciones 360° con manómetro 0 a 10 bar	OP BDM	1
Enchufe de 2 direcciones 360°	OP BD	1



- Permite conservar el tubo recto, y sin forzarlo.
- Mejora la manipulación y la utilización de las herramientas neumáticas.
- Entrada : G 1/4 H
- Salida : R 1/4 M

ACEITE PARA LUBRICADORES

Aceite circuito neumático

T1

Dénominación	Referencia	Emba.
Aceite mineral para aire comprimido, lubricadores, herramientas neumáticas Bidón de 2 litros	LUB 3256	1
Norma ISO : VG 32 Viscosidad : 32 CST (Centistoc) a 40°C Puntot Anilina : 98° C Aceite recomendado para contacto con caucho, elastómero y otros materiales polímeros.		



PISTOLAS DE PINTURA HVLP

Pistola de pintura HVLP por succión

T2

Ø boquilla (mm)	Referencia	Emba.
1	CAR S031HVLP	1
1,4	CAR S032HVLP	1
1,7	CAR S03HVLP	1
2	CAR S033HVLP	1
2,3	CAR S034HVLP	1

Cuerpo de aluminio verde anodizado
 Copa 1 litro de aluminio por oxidación anódica
 Copa de cierre rápido de tipo "estribo", antigoteo
 Gama de presión para una pulverización óptima : de 2 a 3 bar
 Peso : 1,00 kg
 Caudal de aire : 390 l/min a 3 bar
 Enchufe : G 1/4 M
 Enchufe en la copa : G 3/8



ENCHUFES RÁPIDOS CON LUBRICADOR DE LINEA

Conjunto Lub'Air para enchufes montado con diferentes perfiles

T1

Conector	Referencia	Emba.
IRC 06	LUBAIR 6000	1
CRC 06	LUB 6000C	1
IRC 08	LUBAIR 8000	1
Lubricador de línea	LUBAIR 14F	1



Pistola de pintura HVLP por gravedad

T2

Ø boquilla (mm)	Referencia	Emba.
1	CAR G041HVLP	1
1,4	CAR G04HVLP	1
1,5	CAR G042HVLP	1
1,7	CAR G043HVLP	1
2	CAR G044HVLP	1

Cuerpo de aluminio verde anodizado
 Copa 0,6 litro de poliamida
 Gama de presión para una pulverización óptima : de 2 a 3 bar
 Peso : 1,00 kg
 Caudal de aire : 364 l/min a 4 bar
 Enchufe : G 1/4 M
 Enchufe en la copa : M16 x 1,5 P



PISTOLAS DE PINTURA

Pistola de pintura por aspiración para trabajos técnicos T2

Ø boquilla (mm)	Referencia	Emba.
1,5	CAR S031	1
2	CAR S03	1
2,5	CAR S032	1

 Cuerpo de aluminio azul anodizado
 Copa 1 litro de aluminio por oxidación anódica
 Copa de cierre rápido de tipo "estribo", antigoteo
 Presión de servicio : 3,5 a 5 bar
 Peso : 0,95 kg
 Caudal de aire : 260 a 340 l/min
 Enchufe : G 1/4 M
 Enchufe en la copa : G 3/8

Pistola de pintura por aspiración para trabajos industriales T2

Ø boquilla (mm)	Referencia	Emba.
1	CAR S021	1
1,6	CAR S02	1
1,8	CAR S022	1
2	CAR S023	1

 Cuerpo de aluminio azul anodizado
 Copa 1 litro de aluminio por oxidación anódica
 Boquilla de acero inoxidable
 Peso : 1,1 kg
 Caudal de aire : 280 a 360 l/min con 3 bar
 Presión de servicio : 3,5 a 5 bar
 Enchufe : G 1/4 M
 Enchufe en la copa : G 3/8 M

Pistola de pintura por gravedad para trabajos técnicos T2

Ø boquilla (mm)	Referencia	Emba.
1,4	CAR G04	1
1,7	CAR G041	1
2	CAR G042	1

 Cuerpo de aluminio azul anodizado
 Ajuste del caudal de aire comprimido
 Aguja y boquilla de acero inoxidable
 Copa 0,6 litro de poliamida
 Presión de servicio : 3,5 a 5 bar
 Caudal de aire : 250 a 320 l/min
 Peso : 0,6 kg
 Enchufe : G 1/4 M
 Enchufe en la copa : M16 x 1.5 P

Pistola de pintura para retoques de carrocería y barnizado para trabajos de decoración T2

Ø boquilla (mm)	Referencia	Emba.
0,5	CAR G051	1
0,8	CAR G05	1
1	CAR G052	1

 Cuerpo de aluminio azul anodizado
 Copa 0,125 litro de poliamida
 Presión de servicio : 2,6 a 4 bar
 Caudal de aire : 85 a 140 l/min
 Peso : 0,3 kg
 Enchufe : G 1/4 M
 Enchufe en la copa : M16 x 1.5 P

PISTOLAS PARA PINTURA DE BASE ACUOSA

Pistola de pintura HVLP para pintura de base acuosa T2

Ø boquilla (mm)	Referencia	Emba.
1,3	CAR G04HVW	1

 Cuerpo de aluminio
 Copa 0.6 litro
 Aguja y boquilla de acero inoxidable
 Presión para una pulverización óptima : 2 bar
 Presión max. : 3 bar
 Caudal de aire : 285 l/min a 3 bar
 Peso : 0,450 kg
 Enchufe : G 1/4 M
 Enchufe en la copa : M 16 x 1,5 P

Pistola LVLV para pintura de base acuosa T2

Ø boquilla (mm)	Referencia	Emba.
1,3	CAR G04LVW	1

 Cuerpo de aluminio
 Copa 0.6 litro de aluminio por oxidación anódica
 Aguja y boquilla de acero inoxidable
 Presión para una pulverización óptima : 2 bar
 Caudal de aire : 230 l/min a 2 bar
 Peso : 0,450 kg
 Enchufe : G 1/4 M
 Enchufe en la copa : M 16 x 1,5 P

Pistola de pintura HVLP por succión T2

Ø boquilla (mm)	Referencia	Emba.
1,0	CAR G05HVW	1

 Cuerpo de aluminio
 Copa 0,125 litro de poliamida
 Aguja y boquilla de acero inoxidable
 Gama de presión para una pulverización óptima : de 2 a 3 bar
 Caudal de aire : 112 l/min a 3 bar
 Peso : 0,280 kg (pistola) + 0,64 Kg (copa)
 Enchufe : G 1/4 M
 Enchufe en la copa : M 16 x 1.5 P

PIEZAS SUeltas PARA PISTOLA DE PINTURA HVLP

Piezas sueltas para pistola de pintura CAR S03HVLP

T2

Compatibilidad	Referencia	Emba.
Alcachofas para CAR S03HVLP	CAR STAM5	1

Piezas sueltas para pistola de pintura CAR G

T2

Compatibilidad	Referencia	Emba.
Alcachofas para CAR G	CAR GTAM5	1

Accesorios para pistola de pintura CAR S03HVLP

T2

Dénominación	Referencia	Emba.
1. Boquilla 1 mm	CAR S03B10HVLP	1
1. Boquilla 1,7 mm	CAR S03B17HVLP	1
1. Boquilla 2 mm	CAR S03B20HVLP	1
1. Boquilla 2,3 mm	CAR S03B23HVLP	1
Kit boquilla completa 1,7 mm + reglaje completo del caudal de pintura por moleta	CAR S03HVLPK1	1
3. Kit de reglaje de la forma del chorro	CAR S03HVLPK3	1
Kit gatillo + mecanismo completo	CAR S03HVLPK4	1
Kit de caudal de aire + tuerca para enchufe de aire	CAR S03HVLPK5	1
6. Kit completo para copa	CAR S03HVLPK2	1

Accesorios para pistola de pintura CAR G04HVLP

T2

Dénominación	Referencia	Emba.
1. Boquilla Ø 1,0 mm	CAR G04B10HVLP	1
Boquilla 1,3 mm	CAR G04B13HVLP	1
1. Boquilla Ø 1,4 mm	CAR G04B14HVLP	1
1. Boquilla Ø 1,5 mm	CAR G04B15HVLP	1
1. Boquilla Ø 1,7 mm	CAR G04B17HVLP	1
1. Boquilla Ø 2,0 mm	CAR G04B20HVLP	1
Kit boquilla completa Ø 1,4 mm + reglaje completo del caudal de pintura por moleta	CAR G04HVLPK1	1
Kit de reglaje de la forma del chorro	CAR G04HVLPK3	1
4. Kit gatillo + mecanismo completo por pistolas CAR G04HVLP y CAR G04	CAR G04K4	1
Kit de caudal de aire + tuerca para enchufe de aire	CAR G04HVLPK5	1
6. Kit completo copa	CAR G04K2	1

PIEZAS SUeltas PARA PISTOLAS DE PINTURA DE BASE ACUOSA

Boquillas para pistola de pintura de base acuosa CAR G04HVW

T2

Boquilla (Ø - mm)	Referencia	Emba.
1,0	CAR G04B10HVW	1
1,2	CAR G04B12HVW	1
1,3	CAR G04B13HVW	1
1,4	CAR G04B14HVW	1
1,5	CAR G04B15HVW	1
1,6	CAR G04B16HVW	1
1,8	CAR G04B18HVW	1
2,0	CAR G04B20HVW	1
2,5	CAR G04B25HVW	1

Boquillas para pistola de pintura de base acuosa CAR G04LVW

T2

Boquilla (Ø - mm)	Referencia	Emba.
1,0	CAR G04B10LVW	1
1,2	CAR G04B12LVW	1
1,3	CAR G04B13LVW	1
1,4	CAR G04B14LVW	1
1,5	CAR G04B15LVW	1
1,6	CAR G04B16LVW	1
1,8	CAR G04B18LVW	1
2,0	CAR G04B20LVW	1
2,5	CAR G04B25LVW	1

Boquillas para pistola de pintura de base acuosa CAR G05HVW

T2

Boquilla (Ø - mm)	Referencia	Emba.
0,8	CAR G05B08HVW	1
1,0	CAR G05B10HVW	1
1,2	CAR G05B12HVW	1
1,5	CAR G05B15HVW	1

PIEZAS SUeltas PARA PISTOLAS DE PINTURA DE BASE ACUOSA

Accesorios para pistola de pintura de base acuosa G04HVW

T2

	Dénominación	Referencia	Emba.
	2. Kit boquilla completa Ø 1,0 mm con reglaje completo del caudal de pintura por moleta	CAR G04HVWK1	1
	3. Kit de reglaje de la forma del chorro	CAR G04HLVWK3	1
	4. Kit gatillo con mecanismo completo	CAR G04HLVWK4	1
	5. Kit de caudal de aire con tuerca para enchufe de aire	CAR G04HLVWK5	1
	6. Kit completo copa	CAR G04HLVWK2	1

Accesorios sueltas para pistola de pintura de base acuosa G04LVW

T2

	Dénominación	Referencia	Emba.
	2. Kit boquilla completa Ø 1,0 mm con reglaje completo del caudal de pintura por moleta	CAR G04LVWK1	1
	3. Kit de reglaje de la forma del chorro	CAR G04HLVWK3	1
	4. Kit gatillo con mecanismo completo	CAR G04HLVWK4	1
	5. Kit de caudal de aire con tuerca para enchufe de aire	CAR G04HLVWK5	1
	6. Kit completo copa	CAR G04HLVWK2	1

Accesorios sueltas para pistola de pintura de base acuosa G05HVW

T2

	Dénominación	Referencia	Emba.
	2. Kit boquilla completa 1,0 mm con reglaje completo del caudal de pintura por moleta	CAR G05HVWK1	1
	3. Kit de reglaje de la forma del chorro	CAR G05HVWK3	1
	4. Kit gatillo con mecanismo completo	CAR G05HVWK4	1
	5. Kit de caudal de aire con tuerca para enchufe de aire	CAR G05HVWK5	1
	6. Kit completo para copa	CAR G05HVWK2	1

PIEZAS SUeltas PARA PISTOLA DE PINTURA DE PINTURA

Accesorios para pistola de pintura CAR S03

T2

	Dénominación	Referencia	Emba.
	1. Boquilla Ø 1,5 mm	CAR S03B15	1
	1. Boquilla Ø 2,0 mm	CAR S03B20	1
	1. Boquilla Ø 2,5 mm	CAR S03B25	1
	Kit boquilla completa Ø 2 mm + reglaje completo del caudal de pintura por moleta	CAR S03K1	1
	Kit de reglaje de la forma del chorro	CAR S03K3	1
	Kit gatillo + mecanismo completo	CAR S03K4	1
	Kit de caudal de aire + tuerca para enchufe de aire	CAR S03K5	1
	6. Kit completo copa	CAR S02K2	1

Accesorios sueltas para pistola de pintura CAR S02

T2

	Dénominación	Referencia	Emba.
	1. Boquilla Ø 1,0 mm	CAR S02B10	1
	1. Boquilla Ø 1,6 mm	CAR S02B16	1
	1. Boquilla Ø 1,8 mm	CAR S02B18	1
	1. Boquilla Ø 2 mm	CAR S02B20	1
	Kit boquilla completa Ø 1,6 mm + reglaje completo del caudal de pintura por moleta	CAR S02K1	1
	Kit de reglaje de la forma del chorro	CAR S02K3	1
	Kit de caudal de aire + tuerca para enchufe de aire	CAR S02K4	1
	6. Kit completo copa	CAR S02K2	1

PIEZAS SUeltas PARA PISTOLA DE PINTURA

Accesorios para pistola de pintura CAR G04

T2

	Dénominación	Referencia	Emba.
1.	Boquilla Ø 1,3 mm	CAR G04B13	1
	1. Boquilla Ø 1,4 mm	CAR G04B14	1
	1. Boquilla Ø 1,7 mm	CAR G04B17	1
	1. Boquilla Ø 2,0 mm	CAR G04B20	1
2.	Kit boquilla completa 1,4 mm + reglaje completo del caudal de pintura	CAR G04K1	1
3.	Kit de reglaje de la forma del chorro	CAR G04K3	1
4.	Kit gatillo + mecanismo completo por pistolas CAR G04HVLP y CAR G04	CAR G04K4	1
5.	Kit de caudal de aire + tuerca para enchufe de aire	CAR G04K5	1
6.	Kit completo copa	CAR G04K2	1

Accesorios para pistola de pintura CAR G05

T2

	Dénominación	Referencia	Emba.
1.	Boquilla Ø 0,5 mm	CAR G05B05	1
	1. Boquilla Ø 0,8 mm	CAR G05B08	1
	1. Boquilla Ø 1,0 mm	CAR G05B10	1
2.	Kit boquilla completa 0,8 mm + reglaje completo del caudal de pintura por moleta	CAR G05K1	1
3.	Kit de reglaje de la forma del chorro	CAR G05K3	1
4.	Kit gatillo + mecanismo completo	CAR G05K4	1
5.	Kit de caudal de aire + tuerca para enchufe de aire	CAR G05K5	1
6.	Kit completo copa	CAR G05K2	1

KIT DE MANTENIMIENTO.

Kit de mantenimiento

T2

	Compatibilidad	Referencia	Emba.
	Kit de mantenimiento CAR S03HVLP y CAR S03	CAR S03KEN	1
	Kit mantenimiento para pistola CAR S02	CAR S02KEN	1
	Kit de mantenimiento para pistolas CAR G04HVLP y CAR G04	CAR G04KEN	1
	Kit mantenimiento para pistola CAR G05	CAR G05KEN	1
	Kit de mantenimiento para pistolas CAR G04LVW - CAR G04HVV - CAR G05HVV	CAR G04HLVWKEN	1

PISTOLAS DE LAVADO

Pistola de lavado industrial

T2

	Referencia	Emba.
	Rosca hembra BSPP : G 1/2 PL JET	1
	Caudal : 60 l/min a 24 bar 40 l/min a 10 bar	
	Presión máx de uso : máx : 24 bar	
	Material : Pistola latón envenado poliamida	

Pistola de lavado industrial acero inox 316

T2

	Referencia	Emba.
	Rosca hembra BSPP : G 1/2 PL JETI	1
	Caudal : 60 l/min a 20 bar 43 l/min a 10 bar	
	Presión máx de uso : 24 bar	
	Material : Inox 316 envenado caucho EPDM	

Pistola con enchufe para tubo

T2

	Referencia	Emba.
	Composición : PL JET15	1
	- 1 Pistola de lavado PL JET	
	- 1 Enchufe de obturación ELS	
	- 1 Conector rosca macho ELP	
	- 1 Abrazaderas de fijación de tubo	
	Para tubo Ø int. : 15 mm	

PISTOLAS DE LAVADO MULTIFUNCIÓN

Pistola de lavado

T2

	Referencia	Emba.
Rosca hembra BSPP : G 1/2 (enchufe giratorio) Caudal : 50 l/min a 12 bar a 12 bar Presión máx de uso : 12 bar Temperatura : 50° max (°C) Peso : 440 g	PM JET	1



Pistola de lavado inox

T2

	Referencia	Emba.
Rosca hembra BSPP : G 1/2 (enchufe giratorio) Caudal : 50 l/min a 12 bar a 12 bar Presión máx de uso : 12 bar Temperatura : 80° max (°C) Material : Pistola de lavado Inox con protección de poliamida Peso : 440 g	PM JETI	1



PISTOLA PULVERIZADORA

Pistola de pulverización para limpieza

T2

NUEVO	Entrada rosca hembra BSPP	Capacidad (l)	Caudal (Caudal a 8 bar (l/min))	Referencia	Emba.
	G 1/4	1,2	100	BG SPRAY1	1

Pistola de chorro

T2

NUEVO	Entrada rosca hembra BSPP	Capacidad (l)	Caudal (Caudal a 8 bar (l/min))	Referencia	Emba.
	G 1/4	1,2	180	BG SODA1	1

Pistola de arenado

T2

NUEVO	Entrada rosca hembra BSPP	Capacidad (l)	Caudal (Caudal a 8 bar (l/min))	Referencia	Emba.
	G 1/4	1,2	450	BG SAND1	1

Barril de bicarbonato de sodio

T2

NUEVO	Capacidad (l)	Referencia	Emba.
	5	SODA C5	1

BOMBAS DE ENGRASE NEUMÁTICAS

Bomba de engrase para toneles de 12/20 kg

T3

	Longitud del tubo (mm)	Referencia	Emba.
	410	EPG PR20	1

BOMBAS DE ENGRASE NEUMÁTICAS

Bomba de engrase para toneles de 50/60 kg

T3

	Longitud del tubo (mm)	Referencia	Emba.
	730	EPG PR60	1

Kit portátil completo para tonel de grasa 12/20 kg

T3

	Composición	Referencia	Emba.
	- bomba para tonel de 12/20 kg - Long. tubo 410 mm - tapadera + membrana - pistola de distribución - enchufe de estanqueidad - 4 m tubo caucho - empuñadura de transporte	EPG KR20	1
	Kit completo portátil EPG KR20 para tonel de grasa 12/20 kg con FRL	EPG KRF20	1
	Kit completo portátil EPG KR20 para tonel de grasa 12/20 kg con FRL y carro de transporte	EPG KRFC20	1

Kit completo para tonel de grasa de 50 a 60 kg

T3

	Composición	Referencia	Emba.
	- bomba para tonel de 50/60 kg Long. tubo 730 mm - tapadera + membrana - pistola de distribución - enchufe de estanqueidad - 6 m tubo caucho	EPG KR60	1
	Kit completo portátil EPG KR60 para tonel de grasa 50/60 kg con FRL	EPG KRF60	1
	Kit completo portátil EPG KR60 para tonel de grasa 50/60 kg con FRL y carro de transporte	EPG KRFC60	1

Bomba de engrase para toneles de 20/30 kg

T3

	Longitud del tubo (mm)	Referencia	Emba.
	470	EPG PR30	1

Opciones

T3

	Dénominación	Referencia	Emba.
	Pistola con tubo rígido de 15 cm	EPG PT150R	1

Kit completo para tonel de grasa de 20 a 30 kg

T3

	Composición	Referencia	Emba.
	- bomba para tonel de 20/30 kg - Long. tubo 470 mm - tapadera + membrana - pistola de distribución - enchufe de estanqueidad - 6 m tubo caucho	EPG KR30	1
	Kit completo portátil EPG KR30 para tonel de grasa 20/30 kg con FRL	EPG KRF30	1
	Kit completo portátil EPG KR30 para tonel de grasa 20/30 kg con FRL y carro de transporte	EPG KRFC30	1

Opciones

T3

	Dénominación	Referencia	Emba.
	Pistola de distribución con tubo flexible	EPG PT400	1
	Racor del tubo EPG PT400	EPG PT400GRA	1

BOMBAS DE ENGRASE NEUMÁTICAS

Opciones

T3

Dénominación	Referencia	Emba.
(1) Tapadera Ø 280 mm para conjunto EPG KR20	EPG CV20	1
(1) Tapadera Ø 320 mm para conjunto EPG KR30	EPG CV30	1
(1) Tapadera Ø 340 a 380 mm para conjunto EPG KR60	EPG CV60	1
(1) Tapa Ø 380 - 410 mm	EPG CV65	1
(2) Membrana de estanqueidad Ø 270 mm para conjunto EPG KR20	EPG MB20	1
(2) Membrana de estanqueidad Ø 310 mm para conjunto EPF KR30	EPG MB30	1
(2) Membrana de estanqueidad Ø 280 a 300 mm para conjunto EPG KR20 y EPG KR30	EPG MB31	1
(2) Membrana de estanqueidad Ø 300 a 330 mm para conjunto EPG KR30 y EPG KR60	EPG MB34	1
(2) Membrana de estanqueidad Ø 370 mm para conjunto EPG KR60	EPG MB60	1
(2) Membrana de estanqueidad Ø 380 a 410 mm para conjunto EPG KR60	EPG MB65	1
(3) Tubo de caucho 4 m para conjunto EPG KR20	EPG TC414	1
(3) Tubo de caucho 6 m para conjunto EPG KR30 y EPG KR60	EPG TC614	1
(7) Conexión bomba/enrolador grasa	EPG TC214	1
(4) Junta de estanqueidad para conjunto EPG KR20, EPG KR30, EPG KR60	EPG RT14	1
(5) Enchufe cardan de estanqueidad	EPG SW14	1
Empuñadura de transporte para conjunto EPG KR20	EPG PG	1
Tornillo Ø 30 mm para sujeción de la bomba en el interior del tonel	EPG VS30	1
(6) Carro de transporte para tonel de 12/20 kg	EPG CA20	1
(6) Carro de transporte para tonel 20/60 kg	EPG CAN60	1



BOMBAS DE ACEITE NEUMÁTICAS

Bomba de aceite para tonel de 50 a 60 litros

T3

Longitud del tubo (mm)	Referencia	Emba.
730	EPH PR60	1

Kit completo para tonel de 50 a 60 litros

T3

Composición	Referencia	Emba.
Kit completo compuesto de : - bomba para tonel de 50/60 litros Longitud del tubo 730 mm - pistola de distribución de aceite - tubo caucho 5 m, presión 100 bar	EPH KR60	1
Kit completo EPH KR60 para tonel de aceite 50/60 litros con FRL	EPH KRF60	1
Kit completo EPH KR60 para tonel de aceite de 50/60 litros con FRL y carro de transporte	EPH KRFC60	1

Bomba para tonel de 180 a 220 litros

T3

Longitud del tubo (mm)	Referencia	Emba.
940	EPH PR220	1

Bomba de aceite para tonel de 180 a 220 litros

T3

Composición	Referencia	Emba.
Kit completo compuesto de : - bomba para tonel de 180/220 litros Longitud del tubo 940 mm - pistola de distribución de aceite	EPH KR220	1
Kit completo EPH KR220 para tonel de aceite 180/220 litros con FRL	EPH KRF220	1
Kit completo EPH KR220 para tonel de aceite de 180/220 litros con FRL y carro de transporte	EPH KRFC220	1

BOMBAS DE ACEITE NEUMÁTICAS

Bomba de aceite para tonel de 180 a 220 litros

T3

	Dénominación	Referencia	Emba.
	Bomba de aceite	EPH MR220	1

Kit completo MURAL para tonel de aceite de 180 a 220 litros

T3

	Composición	Referencia	Emba.
	- Bomba mural para tonel de 180/220 litros - Longitud del tubo 940 mm - escuadra mural con tuerca G 2 - tubo Ø 1", longitud 2 m - tubo longitud 940 mm con tornillo	EPH MRK220	1
	Kit completo mural EPH MRK220 para tonel de aceite de 180/220 litros con FRL	EPH MRKF220	1

Pistola de medida volumétrica de distribución de aceite

T3

	Entrada rosca hembra BSPP	Función	Referencia	Emba.
	G 1/2	Medida electrónica del volumen de aceite distribuido Lectura de medidas sobre pantalla LCD	EPH VOL12	1
		Caudal : 1 a 30 l/min Precisión : +/- 0,5 % Pérdida de carga : 0,7 bar Presión Máx : 70 bar		

Accesorios para bombas

T3

	Dénominación	Referencia	Emba.
	(1) Tubo de caucho 5 m presión 150 bar para conjunto EPH KR60 et EPH KR220	EPH TC512	1
	(1) Tubo Ø 1" - Longitud 2 m para conjunto EPH MRK220	EPH TC201	1
	(1) Tubo de caucho	EPH TC212	1
	(1) Tubo longitud 1035 mm con tornillo para conjunto EPH MRK220	EPH TB940	1
	Escurridero de aceite con gancho de fijación de pistola	EPH EGR10	1
	Escuadra mural con tuerca G 2 para conjunto EPH MRK220	EPH SP	1
	Pistola de distribución de aceite	EPH PT12	1
	(2) Carro de transporte de tonel de 180/220 litros	EPH CA220	1
	(2) Carro de transporte de tonel de 20/60 litros	EPH CA60	1

Filtración y tratamiento (aire comprimido)



Grupos de tratamiento del aire	160 - 172
Grupos de tratamiento del aire	173
Conjunto portátil	173 - 174
Manómetros	175 - 176
Filtros micrónicos	176 - 184
Purgas eléctricas y mecánicas	184 - 186
Separadores de agua	186
Secadores por refrigeración	187 - 188
Secadores por adsorción	188 - 189



GAMA ALTO 1 - GRUPO DE TRATAMIENTO AIRE COMPRIMIDO G 1/8 - G 1/4

ALTO 1 - Filtro regulador lubricador 3 bloques con manómetro y fijación

T1

Rosca hembra BSPP	Caudal (l/min a 7 bar $\Delta p=1\text{bar}$)	Filtración (μm)	Referencia	Emba.
G 1/8	500	25	TT SMO	1
G 1/4	500	25	TT SM1	1

Equipado con un manómetro : 0 a 10 bar
Presión máx. de uso : 12 bar



ALTO 1 - Filtro regulador lubricador 3 bloques con manómetro, fijación y conexión

T1

Rosca hembra BSPP	Caudal (l/min a 7 bar $\Delta p=1\text{bar}$)	Filtración (μm)	Referencia	Emba.
G 1/4	500	25	TT PSM1	1

Equipado con un manómetro : 0 a 10 bar
Presión máx. de uso : 12 bar



ALTO 1 - Filtro regulador lubricador 2 bloques con manómetro y fijación

T1

Rosca hembra BSPP	Caudal (l/min a 7 bar $\Delta p=1\text{bar}$)	Filtración (μm)	Referencia	Emba.
G 1/8	500	25	KTB SMO	1
G 1/4	500	25	KTB SM1	1

Equipado con un manómetro : 0 a 10 bar
Presión máx. de uso : 12 bar



GAMA ALTO 1 - GRUPO DE TRATAMIENTO AIRE COMPRIMIDO G 1/8 - G 1/4

ALTO 1 - Filtro regulador lubricador 2 bloques con manómetro y fijación con enchufe de seguridad prevoS1

T1

Rosca hembra BSPP	Provisto de 1 enchufe	Referencia	Emba.
G 1/4	ISI 06	KTB SM1IS	1
G 1/4	ESI 07	KTB SM1ES	1

Equipado con un manómetro : 0 a 10 bar
Presión máx. de uso : 12 bar



ALTO 1 - Filtro regulador lubricador 2 bloques con manómetro, fijación y conexión

T1

Rosca hembra BSPP	Caudal (l/min a 7 bar $\Delta p=1\text{bar}$)	Filtración (μm)	Referencia	Emba.
G 1/4	500	25	TB PSM1	1

Equipado con un manómetro : 0 a 10 bar
Presión máx. de uso : 12 bar



ALTO 1 - Filtro regulador lubricador 2 bloques con manómetro, fijación, conexión y distanciador de salida

T1

Rosca hembra BSPP	Caudal (l/min a 7 bar $\Delta p=1\text{bar}$)	Filtración (μm)	Referencia	Emba.
G 1/4	500	25	TB SME1	1

Equipado con un manómetro : 0 a 10 bar
Presión máx. de uso : 12 bar
4 salidas para aire no lubricado



GAMA ALTO 1 - GRUPO DE TRATAMIENTO AIRE COMPRIMIDO G 1/8 - G 1/4

ALTO 1 - Conjunto micrónico con regulador, manómetro y fijación

T1

Rosca hembra BSPP	Caudal (l/min a 6 bar $\Delta p=0,3bar$)	Filtración (μm)	Referencia	Emba.
G 1/4	250	5 y 0,01	TB CSM1	1

Kit compuesto con 2 etapas para aplicación sin aceite
Equipado con un manómetro : 0 a 10 bar
Presión máx. de uso : 12 bar



ALTO 1 - Filtro regulador con manómetro y fijación

T1

Rosca hembra BSPP	Caudal (l/min a 7 bar $\Delta p=1bar$)	Filtración (μm)	Referencia	Emba.
G 1/8	550	25	KTM SMO	1
G 1/4	550	25	KTM SM1	1

Equipado con un manómetro : 0 a 10 bar
Presión máx. de uso : 12 bar



ALTO 1 - Filtro regulador con manómetro y fijación con enchufe de seguridad prevost

T1

Rosca hembra BSPP	Provisto de 1 enchufe	Referencia	Emba.
G 1/4	ISI 06	KTM SM1IS	1
G 1/4	ESI 07	KTM SM1ES	1

Equipado con un manómetro : 0 a 10 bar
Presión máx. de uso : 12 bar



GAMA ALTO 1 - GRUPO DE TRATAMIENTO AIRE COMPRIMIDO G 1/8 - G 1/4

ALTO 1 - Filtro regulador con manómetro, fijación y conexión

T1

Rosca hembra BSPP	Caudal (l/min a 7 bar $\Delta p=1bar$)	Filtración (μm)	Referencia	Emba.
G 1/4	550	25	TM PSM1	1

Equipado con un manómetro : 0 a 10 bar
Presión máx. de uso : 12 bar



ALTO 1 - Regulador con manómetro

T1

Rosca hembra BSPP	Caudal (l/min a 7 bar $\Delta p=1bar$)	Presión de uso (bar)	Referencia	Emba.
G 1/4	600	Entrada : 15 Salida : 0,5-10	TR M1	1

Equipado con un manómetro : 0 a 10 bar



GAMA ALTO 1 - MODULOS G 1/8 - G 1/4

ALTO 1 - Filtro / Micro filtro

T1

	Rosca hembra BSPP	Caudal (l/min a 6 bar $\Delta p=0.3\text{bar}$)	Filtración (μm)	Referencia	Emba.
	G 1/8	800	25	TF 0	1
	G 1/4	800	25	TF 1	1
	G 1/4	800	5	TF 105	1
	G 1/4	250	0,01	TC 1	1
Presión máx. de uso : 12 bar					

ALTO 1 - Lubricador

T1

	Rosca hembra BSPP	Caudal (l/min a 7 bar $\Delta p=0.5\text{bar}$)	Referencia	Emba.
	G 1/8	1350	TL 0	1
	G 1/4	1350	TL 1	1
Presión máx. de uso : 12 bar				

ALTO 1 - Regulador

T1

	Rosca hembra BSPP	Caudal (l/min a 7 bar $\Delta p=1\text{bar}$)	Presión de uso (bar)	Referencia	Emba.
	G 1/8	600	Entrada : 15 Salida : 0,5-10	TR 0	1
	G 1/4	600	Entrada : 15 Salida : 0,5-10	TR 1	1
	G 1/4	600	Entrada : 15 Salida : 0,2-2	TR B21	1
	G 1/4	600	Entrada : 15 Salida : 0,2-4	TR B41	1
Tamaño conector manómetro : G 1/8					

ALTO 1 - Filtro regulador

T1

	Rosca hembra BSPP	Caudal (l/min a 7 bar $\Delta p=1\text{bar}$)	Filtración (μm)	Referencia	Emba.
	G 1/8	550	25	TM 0	1
	G 1/4	550	25	TM 1	1
	G 1/4	550	5	TM 105	1
Presión máx. de uso : 12 bar Salida : 0.5-10 bar					

ALTO 1 - Distanciador de salida

T1

	Rosca hembra BSPP	Salida de aire	Referencia	Emba.
	G 1/4	4 salidas para aire no lubricado	TE 1	1

GAMA ALTO 1 ACCESORIOS

ALTO 1 - Escuadra de fijación

T1

	Dénominación	Referencia	Emba.
	Para filtro o lubricador G 1/4	TP Q1	1
	Para regulador o filtro regulador G 1/4	TR Q1	1
	Tuerca para escuadra de regulador	TR E1	1

ALTO 1 - Juego de ensamblaje y de fijación mural

T1

	Dénominación	Referencia	Emba.
	- 1 juego TA S1 para 2 modulos G 1/4 - 2 juegos TA S1 para 3 modulos G 1/4	TA S1	1

ALTO 1 - Juego de ensamblaje

T1

	Dénominación	Referencia	Emba.
	- 1 juego TA M1 para 2 modulos G 1/4 - 2 juegos TA M1 para 3 modulos G 1/4	TA M1	1

ALTO 1 - Juego de conexiones rápidas en línea

T1

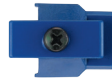
	Rosca hembra BSPP	Referencia	Emba.
	G 1/4	TC P1	1

GAMA ALTO 1 ACCESORIOS

ALTO 1 - Juego de conexión rápida y fijación mural

T1

Rosca hembra BSPP	Referencia	Emba.
G 1/4	TC S1	1

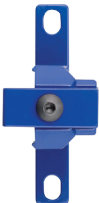

ALTO 1 - Purga automática con flotador

T1

Dénominación	Referencia	Emba.
Para filtro : G 1/8 y G 1/4	TD F1	1



Cartucho filtrante para filtro y micro filtro ALTO 1

T1

Filtración (µm)	Referencia	Emba.
25	TF C1	1
5	TF C105	1
0,01	TF C101	1



Purga manual con botón de drenaje para filtro y filtro-regulador ALTO 1 - 2 - 3 - 4

T1

Dénominación	Referencia	Emba.
Para filtro : G 1/8 - G 1/4 - G 3/8 - G 1/2 - G 3/4 - G 1	TP F45	1



GAMA ALTO 2 - GRUPO DE TRATAMIENTO DE AIRE COMPRIMIDO G 3/8

ALTO 2 - Filtro regulador lubricador 3 bloques con manómetro y fijación

T1

Rosca hembra BSPP	Caudal (l/min a 7 bar Δp=1bar)	Filtración (µm)	Referencia	Emba.
G 3/8	2000	25	TT SM2	1

Equipado con un manómetro : 0 a 10 bar
Presión máx. de uso : 12 bar



ALTO 2 - Filtro regulador lubricador 3 bloques con manómetro, fijación y conexión

T1

Rosca hembra BSPP	Caudal (l/min a 7 bar Δp=1bar)	Filtración (µm)	Referencia	Emba.
G 3/8	2000	25	TT PSM2	1

Equipado con un manómetro : 0 a 10 bar
Presión máx. de uso : 12 bar



ALTO 2 - Filtro regulador lubricador 2 bloques con manómetro y fijación

T1

Rosca hembra BSPP	Caudal (l/min a 7 bar Δp=1bar)	Filtración (µm)	Referencia	Emba.
G 3/8	1250	25	KTB SM2	1

Equipado con un manómetro : 0 a 10 bar
Presión máx. de uso : 12 bar



ALTO 2 - Filtro regulador lubricador 2 bloques con manómetro y fijación con enchufe de seguridad prevoS1

T1

Rosca hembra BSPP	Provisto de 1 enchufe	Referencia	Emba.
G 3/8	ISI 06	KTB SM2IS	1
G 3/8	ESI 07	KTB SM2ES	1

Equipado con un manómetro : 0 a 10 bar
Presión máx. de uso : 12 bar



GAMA ALTO 2 - GRUPO DE TRATAMIENTO DE AIRE COMPRIMIDO G 3/8

ALTO 2 - Filtro regulador lubricador 2 bloques con manómetro, fijación y conexión

T1

Rosca hembra BSPP	Caudal (l/min a 7 bar $\Delta p=1\text{bar}$)	Filtración (μm)	Referencia	Emba.
G 3/8	1250	25	TB PSM2	1

Dotado di un manómetro : 0 a 10 bar
Equipado con un manómetro : 0 a 10 bar



GAMA ALTO 2 - GRUPO DE TRATAMIENTO DE AIRE COMPRIMIDO G 3/8

ALTO 2 - Filtro regulador con manómetro y fijación con enchufe de seguridad prevoS1

T1

Rosca hembra BSPP	Provisto de 1 enchufe	Referencia	Emba.
G 3/8	ISI 06	KTM SM2IS	1
G 3/8	ESI 07	KTM SM2ES	1

Equipado con un manómetro : 0 a 10 bar
Presión máx. de uso : 12 bar



ALTO 2 - Filtro regulador lubricador 2 bloques con manómetro, fijación, conexión y distanciador de salida

T1

Rosca hembra BSPP	Caudal (l/min a 7 bar $\Delta p=1\text{bar}$)	Filtración (μm)	Referencia	Emba.
G 3/8	1250	25	TB SME2	1

Dotado di un manómetro : 0 a 10 bar
Equipado con un manómetro : 0 a 10 bar
4 salidas para aire no lubricado



ALTO 2 - Filtro regulador con manómetro, fijación y conexión

T1

Rosca hembra BSPP	Caudal (l/min a 7 bar $\Delta p=1\text{bar}$)	Filtración (μm)	Referencia	Emba.
G 3/8	1800	25	TM PSM2	1

Equipado con un manómetro : 0 a 10 bar



ALTO 2 - Filtro regulador con manómetro y fijación

T1

Rosca hembra BSPP	Caudal (l/min a 7 bar $\Delta p=1\text{bar}$)	Filtración (μm)	Referencia	Emba.
G 3/8	1800	25	KTM SM2	1

Equipado con un manómetro : 0 a 10 bar
Presión máx. de uso : 12 bar



ALTO 2 - Regulador con manómetro

T1

Rosca hembra BSPP	Caudal (l/min a 7 bar $\Delta p=1\text{bar}$)	Presión de uso (bar)	Referencia	Emba.
G 3/8	2500	Entrada : 15 Salida : 0,5-10	TR M2	1

Equipado con un manómetro : 0 a 10 bar



GAMA ALTO 2 - MODULOS G 3/8

ALTO 2 - Filtro / Micro filtro

T1

Rosca hembra BSPP	Caudal (l/min a 6 bar $\Delta p=0.3\text{bar}$)	Filtración (μm)	Referencia	Emba.
G 3/8	2250	25	TF 2	1
G 3/8	2250	5	TF 205	1
Presión máx. de uso : 12 bar				

ALTO 2 - Regulador

T1

Rosca hembra BSPP	Caudal (l/min a 7 bar $\Delta p=1\text{bar}$)	Presión de uso (bar)	Referencia	Emba.
G 3/8	2500	Entrada : 15 Salida : 0,5-10	TR 2	1
Tamaño conector manómetro : G 1/8				

ALTO 2 - Lubricador

T1

Rosca hembra BSPP	Caudal (l/min a 6 bar $\Delta p=0.5\text{bar}$)	Referencia	Emba.
G 3/8	3000	TL 2	1
Presión máx. de uso : 12 bar			

ALTO 2 - Filtro regulador

T1

Rosca hembra BSPP	Caudal (l/min a 7 bar $\Delta p=1\text{bar}$)	Filtración (μm)	Referencia	Emba.
G 3/8	1800	25	TM 2	1
G 3/8	1800	25 con purga automática	TM D2	1
Presión máx. de uso : 12 bar Salida : 0.5-10 bar				

ALTO 2 - Distanciator de salida

T1

Rosca hembra BSPP	Salida de aire	Referencia	Emba.
G 3/8	4 salidas para aire no lubricado	TE 2	1

GAMA ALTO 2 - ACCESORIOS G 3/8

ALTO 2 - Escuadra de fijación

T1

Dénominación	Referencia	Emba.
Para filtro o lubricador G 3/8	TP Q2	1
Para regulador o filtro regulador G 3/8	TR Q2	1
Tuerca para escuadra de regulador	TR E2	1

ALTO 2 - Juego de ensamblaje

T1

Dénominación	Referencia	Emba.
- 1 juego TA M2 para 2 modulos G 3/8 - 2 juegos TA M2 para 3 modulos G 3/8	TA M2	1

ALTO 2 - Juego de ensamblaje y de fijación mural

T1

Dénominación	Referencia	Emba.
- 1 juego TA S2 para 2 modulos G 3/8 - 2 juegos TA S2 para 3 modulos G 3/8	TA S2	1

ALTO 2 - Juego de conexiones rápidas en línea

T1

Rosca hembra BSPP	Referencia	Emba.
G 3/8	TC P2	1

GAMA ALTO 2 - ACCESORIOS G 3/8

ALTO 2 - Juego de conexión rápida y fijación mural

T1

Rosca hembra BSPP	Referencia	Emba.
G 3/8	TC S2	1



ALTO 2 - Purga automática con flotador

T1

Dénominación	Referencia	Emba.
Para filtro : G 3/8	TD F2	1



Cartucho filtrante para filtro ALTO 2

T1

Filtración (µm)	Referencia	Emba.
25	TF C2	1
5	TF C205	1



Purga manual con botón de drenaje para filtro y filtro-regulador ALTO 1 - 2 - 3 - 4

T1

Dénominación	Referencia	Emba.
Para filtro : G 1/8 - G 1/4 - G 3/8 - G 1/2 - G 3/4 - G 1	TP F45	1



GAMA ALTO 3 - GRUPO DE TRATAMIENTO AIRE COMPRIMIDO G 1/2

ALTO 3 - Filtro regulador lubricador 3 bloques con manómetro y fijación

T1

Rosca hembra BSPP	Caudal (l/min a 7 bar Δp=1bar)	Filtración (µm)	Referencia	Emba.
G 1/2	3500	25	TT SM3	1

Equipado con un manómetro : 0 a 10 bar
Presión máx. de uso : 12 bar



ALTO 3 - Filtro regulador lubricador 3 bloques con manómetro, fijación y conexión

T1

Rosca hembra BSPP	Caudal (l/min a 7 bar Δp=1bar)	Filtración (µm)	Referencia	Emba.
G 1/2	3500	25	TT PSM3	1

Equipado con un manómetro : 0 a 10 bar
Presión máx. de uso : 12 bar



ALTO 3 - Filtro regulador lubricador 2 bloques con manómetro y fijación

T1

Rosca hembra BSPP	Caudal (l/min a 7 bar Δp=1bar)	Filtración (µm)	Referencia	Emba.
G 1/2	2800	25	KTB SM3	1

Equipado con un manómetro : 0 a 10 bar
Presión máx. de uso : 12 bar



GAMA ALTO 3 - GRUPO DE TRATAMIENTO AIRE COMPRIMIDO G 1/2

ALTO 3 - Filtro regulador lubricador 2 bloques con manómetro y fijación con enchufe de seguridad prevoS1 **T1**

Rosca hembra BSPP	Provisto de 1 enchufe	Referencia	Emba.
G 1/2	ISI 06	KTB SM3IS	1
G 1/2	ESI 07	KTB SM3ES	1

Equipado con un manómetro : 0 a 10 bar
Presión máx. de uso : 12 bar



ALTO 3 - Filtro regulador lubricador 20 bar 2 bloques con manómetro y fijación **T1**

Rosca hembra BSPP	Caudal (l/min a 7 bar $\Delta p=1\text{bar}$)	Presión de uso (bar)	Referencia	Emba.
G 1/2	3000	Entrada : 20 Salida : 0,5-12,5	TB HPSM3	1

Tanque metálico sin testigo indicador
Manómetro : 0 a 16 bar



ALTO 3 - Filtro regulador lubricador 2 bloques con manómetro, fijación y conexión **T1**

Rosca hembra BSPP	Caudal (l/min a 7 bar $\Delta p=1\text{bar}$)	Filtración (μm)	Referencia	Emba.
G 1/2	2800	25	TB PSM3	1

Equipado con un manómetro : 0 a 10 bar
Presión máx. de uso : 12 bar



GAMA ALTO 3 - GRUPO DE TRATAMIENTO AIRE COMPRIMIDO G 1/2

ALTO 3 - Filtro regulador lubricador 2 bloques con manómetro, fijación y conexión **T1**

Rosca hembra BSPP	Caudal (l/min a 7 bar $\Delta p=1\text{bar}$)	Filtración (μm)	Referencia	Emba.
G 1/2	2800	25	TB SME3	1

Equipado con un manómetro : 0 a 10 bar
Presión máx. de uso : 12 bar
4 salidas para aire no lubricado



ALTO 3 - Kit con un filtro micrónico, regulador y manómetro **T1**

Rosca hembra BSPP	Caudal (l/min a 6 bar $\Delta p=0.3\text{bar}$)	Filtración (μm)	Referencia	Emba.
G 1/2	1500	5 y 0,01	KTB CSM3	1

Kit compuesto con 2 etapas para aplicación sin aceite
Equipado con un manómetro (limbo de vidrio) : 0 a 10 bar
Presión máx. de uso : 12 bar



PINTURA

ALTO 3 - Kit con un filtro micrónico, regulador y manómetro con enchufe de seguridad prevoS1 **T1**

Rosca hembra BSPP	Filtración (μm)	Provisto de 1 enchufe	Referencia	Emba.
G 1/2	5 y 0,01	ISI 06	KTB CSM3IS	1
G 1/2	5 y 0,01	ESI 07	KTB CSM3ES	1

Equipado con un manómetro (limbo de vidrio) : 0 a 10 bar
Presión máx. de uso : 12 bar



PINTURA

GAMA ALTO 3 - GRUPO DE TRATAMIENTO AIRE COMPRIMIDO G 1/2

ALTO 3 - Filtro regulador con manómetro y fijación T1

Rosca hembra BSPP	Caudal (l/min a 7 bar $\Delta p=1\text{bar}$)	Filtración (μm)	Referencia	Emba.
G 1/2	3000	25	KTM SM3	1

Equipado con un manómetro : 0 a 10 bar
Presión máx. de uso : 12 bar



ALTO 3 - Filtro regulador con manómetro y fijación con enchufe de seguridad prevoS1 T1

Rosca hembra BSPP	Provisto de 1 enchufe	Referencia	Emba.
G 1/2	ISI 06	KTM SM3IS	1
G 1/2	ESI 07	KTM SM3ES	1

Equipado con un manómetro : 0 a 10 bar
Presión máx. de uso : 12 bar



ALTO 3 - Filtro regulador con manómetro, fijación y conexión T1

Rosca hembra BSPP	Caudal (l/min a 7 bar $\Delta p=1\text{bar}$)	Filtración (μm)	Referencia	Emba.
G 1/2	3000	25	TM PSM3	1

Equipado con un manómetro : 0 a 10 bar
Presión máx. de uso : 12 bar



GAMA ALTO 3 - GRUPO DE TRATAMIENTO AIRE COMPRIMIDO G 1/2

ALTO 3 - Filtro regulador 20 bar con manómetro y fijación T1

Rosca hembra BSPP	Caudal (l/min a 7 bar $\Delta p=1\text{bar}$)	Presión de uso (bar)	Referencia	Emba.
G 1/2	3000	Entrada : 20 Salida : 0,5-12,5	TM HPSM3	1

Tanque metálico sin testigo indicador
Filtración : 40 μm
Presión máx. de uso : 0 a 16 bar



ALTO 3 - Regulador con manómetro T1

Rosca hembra BSPP	Caudal (l/min a 7 bar $\Delta p=1\text{bar}$)	Presión de uso (bar)	Referencia	Emba.
G 1/2	4000	Entrada : 15 Salida : 0,5-10	TR M3	1

Equipado con un manómetro : 0 a 10 bar



ALTO 3 - Regulador 20 bar con manómetro T1

Rosca hembra BSPP	Caudal (l/min a 7 bar $\Delta p=1\text{bar}$)	Presión de uso (bar)	Referencia	Emba.
G 1/2	4000	Entrada : 20 Salida : 0,5-12,5	TR HPM3	1

Equipado con un manómetro : 0 a 16 bar



ALTO 3 - Regulador 40 bar con manómetro T1

Rosca hembra BSPP	Caudal (l/min a 10 bar)	Presión de uso (bar)	Referencia	Emba.
G 1/2	5000	Entrada : 40 Salida : 0,5-30	TR VHMP3	1

El regulador TR VHMP3 es independiente de la gama ALTO.
No entra la composición de los conjuntos ALTO
Equipado con un manómetro : 0 - 40 bar



GAMA ALTO 3 - MODULOS G 1/2

ALTO 3 - Filtro / Micro filtro

T1

Rosca hembra BSPP	Caudal (l/min a 6 bar $\Delta p=0,3\text{bar}$)	Filtración (μm)	Referencia	Emba.
G 1/2	3500	25	TF 3	1
G 1/2	3500	5	TF 305	1
G 1/2	1500	0,01	TC 3	1
Presión máx. de uso : 12 bar				

ALTO 3 - Regulador 20 bar

T1

Rosca hembra BSPP	Caudal (l/min a 7 bar $\Delta p=1\text{bar}$)	Presión máx de uso (bar)	Referencia	Emba.
G 1/2	4000	Entrada : 20 Salida : 0,5-12,5	TR HP3	1
Tanamaño conector manómetro : G 1/8				

ALTO 3 - Regulador

T1

Rosca hembra BSPP	Caudal (l/min a 7 bar $\Delta p=1\text{bar}$)	Presión de uso (bar)	Referencia	Emba.
G 1/2	4000	Entrada : 15 Salida : 0,5-10	TR 3	1
G 1/2	4000	Entrada : 15 Salida : 0,2-2	TR B23	1
G 1/2	4000	Entrada : 15 Salida : 0,2-4	TR B43	1
Tamaño conector manómetro : G 1/8				

ALTO 3 - Lubricador 20 bar

T1

Rosca hembra BSPP	Caudal (l/min a 6 bar $\Delta p=0,5\text{bar}$)	Presión máx de uso (bar)	Referencia	Emba.
G 1/2	5650	20	TL A3	1
Modulo con cubeta metálica sin testigo indicador				

ALTO 3 - Lubricador

T1

Rosca hembra BSPP	Caudal (l/min a 6 bar $\Delta p=0,5\text{bar}$)	Referencia	Emba.
G 1/2	5650	TL 3	1
Presión máx. de uso : 12 bar			

ALTO 3 - Filtro regulador 20 bar

T1

Rosca hembra BSPP	Caudal (l/min a 7 bar $\Delta p=1\text{bar}$)	Presión de uso (bar)	Referencia	Emba.
G 1/2	3000	Entrada : 20 Salida : 0,5-10	TM A305	1
G 1/2	3000	Entrada : 20 Salida : 0,5-12,5	TM HP3	1
Filtración : 40 μm Tanque metálico sin testigo indicador				

ALTO 3 - Filtro regulador

T1

Rosca hembra BSPP	Caudal (l/min a 7 bar $\Delta p=1\text{bar}$)	Filtración (μm)	Referencia	Emba.
G 1/2	3000	25	TM 3	1
G 1/2	3000	5	TM 305	1
G 1/2	3000	25 con purga automática	TM D3	1
Presión máx. de uso : 12 bar Salida : 0.5-10 bar				

ALTO 3 - Distanciador de salida

T1

Rosca hembra BSPP	Salida de aire	Referencia	Emba.
G 1/2	4 salidas para aire no lubricado	TE 3	1

GAMA ALTO 3 - ACCESORIOS G 1/2

ALTO 3 - Escuadra de fijación

T1

	Dénominación	Referencia	Emba.
	Para filtro o lubricador G 1/2	TP Q3	1
	Para regulador o filtro regulador G 1/2	TR Q3	1
	Tuerca para escuadra de regulador	TR E3	1

ALTO 3 - Juego de conexiones

T1

	Dénominación	Referencia	Emba.
	- 1 juego TA M3 para 2 modulos G 1/2	TA M3	1
	- 2 juegos TA M3 para 3 modulos G 1/2		

ALTO 3 - Juego de ensamblaje y de fijación mural

T1

	Dénominación	Referencia	Emba.
	- 1 juego TA S3 para 2 modulos G 1/2	TA S3	1
	- 2 juegos TA S3 para 3 modulos G 1/2		

ALTO 3 - Juego de conexiones rápidas en línea

T1

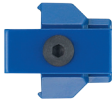
	Rosca hembra BSPP	Referencia	Emba.
	G 1/2	TC P3	1
	G 3/4	TC P34	1

GAMA ALTO 3 - ACCESORIOS G 1/2

ALTO 3 - Juego de conexión rápida y fijación mural

T1

	Rosca hembra BSPP	Referencia	Emba.
	G 1/2	TC S3	1
	G 3/4	TC S34	1

ALTO 3 - 4 - Purga automática con flotador

T1

	Dénominación	Referencia	Emba.
	Para filtros : G 1/2 - G 3/4 - G 1	TD F3	1

Cartucho filtrante para filtro y micro filtro ALTO 3

T1

	Filtración (µm)	Referencia	Emba.
	25	TF C3	1
	5	TF C305	1
	0,01	TF C301	1

Purga manual con botón de drenaje para filtro y filtro-regulador ALTO 1 - 2 - 3 - 4

T1

	Dénominación	Referencia	Emba.
	Para filtro : G 1/8 - G 1/4 - G 3/8 - G 1/2 - G 3/4 - G 1	TP F45	1

GAMA ALTO 4 - UNIDADES DE TRATAMIENTO AIRE COMPRIMIDO G 3/4 - G 1

ALTO 4 - Conjunto 3 bloques con filtro manómetro regulador lubricador

T1

Rosca hembra BSPP	Caudal (l/min a 7 bar $\Delta p=1\text{bar}$)	Referencia	Emba.
G 3/4	3500	TT SM4	1
G 1	5000	TT SM5	1
Equipado con un manómetro : 0 a 10 bar			



ALTO 4 - Conjunto 3 bloques con fijación y conexión

T1

Rosca hembra BSPP	Caudal (l/min a 7 bar $\Delta p=1\text{bar}$)	Referencia	Emba.
G 3/4	3500	TT PSM4	1
G 1	5000	TT PSM5	1
Equipado con un manómetro : 0 a 10 bar			



GAMA ALTO 4 - MODULOS G 3/4 - G 1

ALTO 4 - Filtro

T1

Rosca hembra BSPP	Caudal (l/min a 6 bar $\Delta p=0.3\text{bar}$)	Filtración (μm)	Referencia	Emba.
G 3/4	5000	25	TF 4	1
G 1	6500	25	TF 5	1



ALTO 4 - Regulador

T1

Rosca hembra BSPP	Caudal (l/min a 7 bar $\Delta p=1\text{bar}$)	Referencia	Emba.
G 3/4	5000	TR 4	1
G 1	6000	TR 5	1
Tamaño conector manómetro : G 1/4			



ALTO 4 - Lubricador

T1

Rosca hembra BSPP	Caudal (l/min a 6 bar $\Delta p=0.5\text{bar}$)	Referencia	Emba.
G 3/4	7200	TL 4	1
G 1	9000	TL 5	1



ALTO 4 - Filtro regulador

T1

Rosca hembra BSPP	Caudal (l/min a 7 bar $\Delta p=1\text{bar}$)	Presión de uso (bar)	Referencia	Emba.
G 3/4	4250	Entrada : 12 Salidad : 0,5-10	TM 4	1
G 1	5500	Entrada : 12 Salidad : 0,5-10	TM 5	1
Filtración : 25 μm				



GAMA ALTO 4 - ACCESORIOS G 3/4 - G 1



ALTO 4 - Juego de ensamblaje y de fijación mural G 3/4 - G 1 T1

	Dénominación	Referencia	Emba.
	1 juego TA S45 para 2 modulos	TA S45	1
	2 juegos TA S45 para 3 modulos		

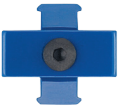
ALTO 4 - Juego de ensamblaje G 3/4 - G1 T1

	Dénominación	Referencia	Emba.
	1 juego TA M45 para 2 modulos	TA M45	1
	2 juegos TA M45 para 3 modulos		

ALTO 4 - Escuadra de fijación G 3/4 - G 1 T1

	Dénominación	Referencia	Emba.
  	Para filtro y lubricador	TP Q45	1
	Para regulador y filtro regulador	TR Q45	1

ALTO 4 - Juego de conexiones rápidas en línea T1

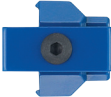
	Dénominación	Referencia	Emba.
	1 adaptator roscado G 3/4	TC P4	1
	1 adaptor roscado G 1	TC P5	1

GAMA ALTO 4 - ACCESORIOS G 3/4 - G 1

ALTO 3 - 4 - Purga automática con flotador T1

	Dénominación	Referencia	Emba.
	Para filtros : G 1/2 - G 3/4 - G 1	TD F3	1

Elemento filtro ALTO 4 T1

	Filtración (µm)	Referencia	Emba.
	25	TF C45	1

Purga manual con botón de drenaje para filtro y filtro-regulador ALTO 1 - 2 - 3 - 4 T1

	Dénominación	Referencia	Emba.
	Para filtro : G 1/8 - G 1/4 - G 3/8 - G 1/2 - G 3/4 - G 1	TP F45	1

GAMA ALTO MAX - G 1 1/4 A G 2 1/2

Filtro ALTO MAX con cuba metálica

T1

Rosca hembra BSPP	Caudal (l/min a 7 bar $\Delta p=33\text{bar}$)	Referencia	Emba.
G 1 1/4	9000	TX F42	1
G 1 1/2	11000	TX F49	1
G 2	29000	TX F60	1
G 2 1/2	36000	TX F76	1
Filtración : 40 μm			

ALTO MAX Maxicube

T1

Rosca hembra BSPP	Caudal (l/min a 7 bar $\Delta p=33\text{bar}$)	Presión de uso (bar)	Referencia	Emba.
G 1 1/4	10000	Entrada : 21 Salida : 0-9	TX RG42	1
G 1 1/2	12000	Entrada : 21 Salida : 0-9	TX RG49	1
G 2	42000	Entrada : 21 Salida : 0-9	TX RG60	1
G 2 1/2	44000	Entrada : 21 Salida : 0-9	TX RG76	1
A equipar con un manómetro MT RA1050. Modelos G 2 y G 2 1/2 controlados por el regulador				

Lubricador ALTO MAX

T1

Rosca hembra BSPP	Caudal (l/min a 7 bar $\Delta p=33\text{bar}$)	Referencia	Emba.
G 1 1/4	14000	TX L42	1
G 1 1/2	17000	TX L49	1
G 2	28000	TX L60	1
Filtración : 40 μm			

Cartucho filtrante para filtro

T1

Filtración	Referencia	Emba.
Cartucho 40 μm por TXF 42 a TXF 49	TX CAFG1	1
Cartucho 40 μm por TXF 60 a TXF 76	TX CAFG2	1

Purga automática para filtros ALTO MAX

T1

Dénominación	Referencia	Emba.
Flotador para purga automática	MCP 500	1

CONJUNTO DE TRATAMIENTO DE AIRE EN PORTÁTIL

Conjunto portátil filtro mano-regulador lubricador - Media presión

T1

Referencia	Emba.
PT HPIS	1
Perfil : ISO 6150 B Entrada : 1 inneso : IRP 06 Filtración : 40 μm Salida : 2 enchufes : ISI 06	
PT HPES	1
Perfil : European 7,4 mm Entrada : 1 connector : ERP 07 Filtración : 40 μm Salida : 2 enchufes : ESI 07	
Modulos con cubeta metálica sin testigo indicador e manómetro : 0-16 bar Presión de entrada : 20 bar Presión di salida : 0,5-12,5 bar	

Conjunto portátil filtro regulador lubricador con distanciador de salida para aire no lubricado y 3 enchufes rápidos

T1

Referencia	Emba.
PTE IS	1
Perfil : ISO 6150 B Entrada : 1 inneso : IRP 06 Filtración : 25 μm Salida : 3 enchufes : 2 x ISI 06 1 x ISI 06 (salida non lubricado)	
PTE ES	1
Perfil : European 7,4 mm Entrada : 1 inneso : ERP 07 Filtración : 25 μm Salida : 3 enchufes : 2 x ESI 07 1 x ESI 07 (salida non lubricado)	
PTE CM6	1
Perfil : ISO 6150 C Entrada : CRP 06 Filtración : 25 μm Salida : 3 enchufes : 2 x CSM 06 1 x CSM 06 (salida non lubricado)	
PTE CM8	1
Perfil : ISO 6150 C Entrada : CRP 08 Filtración : 25 μm Salida : 3 enchufes : 2 x CSM 08 1 x CSM 08 (salida non lubricado)	
Equipado con un manómetro : 0-10 bar Presión de entrada : 12 bar Presión di salida : 0,5-10 bar	

CONJUNTO DE TRATAMIENTO DE AIRE EN PORTÁTIL

Conjunto portátil filtro mano-regulador lubricador con distanciador de salida para aire no lubricado

T1

	Referencia	Emba.
Perfil : ISO 6150 B Entrada : 1 inestodo : IRP 06 Filtración : 40 µm Salida de aire : 2 x ISI06 1 x ISI 06 (salida non lubricado)	PTE HPIS	1
Perfil : ISO 6150 B Entrada : 1 connector : IRP 11 Filtración : 40 µm Salida de aire : 1 x ISI 11 1 x ISI 06 (salida non lubricado)	PTE HPIS11	1
Perfil : European 7,4 mm Entrada : 1 connector : ERP 07 Filtración : 40 µm Salida de aire : 2 x ESI 07 1 x ESI 07 (salida non lubricado)	PTE HPES	1
Modulos con manómetro : 0-16 bar e cubetas metálicas Media presión Presión de entrada : 20 bar Presión di salida : 0,5-12,5 bar		



CONJUNTO DE TRATAMIENTO DE AIRE EN PORTÁTIL

Conjunto portátil filtro regulador lubricador con una salida para aire no lubricado y 3 enchufes rápidos

T1

	Referencia	Emba.
Perfil : ISO 6150 B Entrada : 1 connector : IRP 11 Filtración : 25 µm Salida : 3 enchufes : 2 x ISG 11 1 x ISI 06 (salida non lubricado)	PTE LIS	1
Perfil : ISO 6150 C Entrada : 1 connector : CRP 11 Filtración : 25 µm Salida : 3 enchufes : 2 x CSM 11 1 x CSM 08 (salida non lubricado)	PTE LCM11	1
Equipado con un manómetro 0 - 16 bar Presión de entrada : 12 bar Presión di salida : 0,5-10 bar		



TRABAJOS PESADOS

Scuadra fijación mural para portátil

T1

Dénominación	Referencia	Emba.
Scuadra fijación mural	PT K	1
Adaptable a los 2 modelos estándar y largo		



Conjunto portátil filtro regulador con manómetro y microfiltro TB CSM3

T1

	Referencia	Emba.
Perfil : ISO 6150 B Entrada : 1 connector : IRP 06 Filtración : 5 y 0,01 µm Salida : 2 enchufes : ISI 06	PTC IS	1
Perfil : European 7,4 mm Entrada : 1 connector : ERP 07 Filtración : 5 y 0,01 µm Salida : 2 enchufes : ESI 07	PTC ES	1
Perfil : ISO 6150 C Entrada : 1 connector : CRP 06 Filtración : 5 y 0,01 µm Salida : 2 enchufes : CSM 06	PTC CM6	1
Perfil : ISO 6150 C Entrada : CRP 08 Filtración : 5 y 0,01 µm Salida : 2 enchufes : CSM 08	PTC CM8	1
Equipado con un manómetro : 0-10 bar limbo de vidrio compatible solventes Presión de entrada : 12 bar Presión di salida : 0,5-10 bar		



PINTURA

Ruedas para portátil

T1

Dénominación	Referencia	Emba.
Juego de 4 ruedas	PT RL	1



ACEITE PARA LUBRICADORES

Aceite circuito neumático

T1

Dénominación	Referencia	Emba.
Aceite mineral para aire comprimido, lubricadores, herramientas neumáticas Bidón de 2 litros	LUB 3256	1
Norma ISO : VG 32 Viscosidad : 32 CST (Centistoc) a 40°C Punot Anilina : 98° C Aceite recomendado para contacto con caucho, elastómero y otros materiales polímeros.		



MANÓMETROS

Manómetro caja cuadrada 40 x 40 mm

T1

Graduación (bar)	Fijación rosca macho BSPP	Material	Referencia	Emba.
0 - 4	G 1/8	Limbo de plexiglass	MT CA0440	1
0 - 6	G 1/8	Limbo de plexiglass	MT CA0640	1
0 - 10	G 1/8	Limbo de plexiglass	MT CA1040	1
0 - 16	G 1/8	Limbo de plexiglass	MT CA1640	1
Fijación dorsal preestanca				



Manómetro caja redonda Ø 23 mm

T1

Graduación (bar)	Fijación rosca macho BSPP	Material	Referencia	Emba.
0 - 12	G 1/8	Limbo de plexiglass	MT RA1023	1
Fijación dorsal preestanca				



Manómetro caja redonda Ø 40 mm

T1

Graduación (bar)	Fijación rosca macho BSPP	Material	Referencia	Emba.
0 - 2,5	G 1/8	Limbo de plexiglass	MT RA0240	1
0 - 4	G 1/8	Limbo de plexiglass	MT RA0440	1
0 - 10	G 1/8	Limbo de plexiglass	MT RA1040	1
0 - 16	G 1/8	Limbo de plexiglass	MT RA1640	1
Fijación dorsal preestanca				



Manómetro caja redonda Ø 50 mm

T1

Graduación (bar)	Fijación rosca macho BSPP	Material	Referencia	Emba.
0 - 4	G 1/4	Limbo de plexiglass	MT RA0450	1
0 - 10	G 1/4	Limbo de plexiglass	MT RA1050	1
0 - 25	G 1/4G 1/4	Limbo de plexiglass	MT RA2550	1
0 - 40	G 1/4	Limbo de plexiglass	MT RA4050	1
Fijación dorsal preestanca				



MANÓMETROS

Manómetro caja redonda Ø 63 mm

T1

Graduación (bar)	Fijación rosca macho BSPP	Material	Referencia	Emba.
0 - 2,5	G 1/4	Limbo de plexiglass	MT RA0263	1
0 - 10	G 1/4	Limbo de plexiglass	MT RA1063	1
0 - 16	G 1/4	Limbo de plexiglass	MT RA1663	1
Fijación dorsal preestanca				



Manómetro caja redonda Ø 50 mm

T1

Graduación (bar)	Fijación rosca macho BSPP	Material	Referencia	Emba.
0 - 4	G 1/8	Limbo de plexiglass	MT RS0450	1
0 - 10	G 1/8	Limbo de plexiglass	MT RS1050	1
Fijación radial "6 horas" Preestanca				



Manómetro caja redonda Ø 50 mm

T1

Graduación (bar)	Fijación rosca macho BSPP	Material	Referencia	Emba.
0 - 12	G 1/4	Limbo de plexiglass	MT RS1250	1
0 - 16	G 1/4	Limbo de plexiglass	MT RS1650	1
Fijación radial "6 horas" Preestanca				



Manómetro integrable con collarín redondo Ø 40 mm

T1

Graduación (bar)	Fijación rosca macho BSPP	Material	Referencia	Emba.
0 - 10	G 1/8	Limbo de vidrio compatible con solventes Ø 40 mm	MT IA1040V	1
Fijación dorsal preestanca				



LIMBO DE VIDRIO

MANÓMETROS

Manómetro integrable con collarín Ø 50 mm

T1

Graduación (bar)	Fijación rosca macho BSPP	Material	Referencia	Emba.
0 - 6	G 1/8	Limbo de vidrio compatible con solventes	MT IA0650V	1
0 - 10	G 1/8	Limbo de vidrio compatible con solventes	MT IA1050V	1
Fijación dorsal preestanca				



LIMBO DE VIDRIO

Manómetro integrable con collarín redondo Ø 63 mm

T1

Graduación (bar)	Fijación rosca macho BSPP	Material	Referencia	Emba.
0 - 10	G 1/4	Limbo de vidrio compatible con solventes	MT IA1063V	1
0 - 16	G 1/4	Limbo de vidrio compatible con solventes	MT IA1663V	1
Fijación dorsal preestanca				



LIMBO DE VIDRIO

Manómetro con baño glicerina redondo Ø 63 mm

T1

Graduación (bar)	Fijación rosca macho BSPP	Material	Referencia	Emba.
0 - 16	G 1/4	Caja y anillo de acero inox	MT GA1365	1
Fijación radial "6 horas" Especialmente adaptado a los aparatos sometidos a vibraciones importantes				



SERIE MFM FILTRO MICRÓNICO

Filtración de base MFM - Umbral de filtración : 1 µm

T1

Rosca hembra (BSPP)	Caudal (in m³/h a 7 bar)	Referencia	Emba.
G 1/4	34	MFM 101	1
G 3/8	59	MFM 102	1
G 1/2	85	MFM 103	1
G 3/4	127	MFM 104	1
G 3/4	175	MFM 105	1
G 1	267	MFM 106	1
G 1 1/2	437	MFM 107	1
G 1 1/2	612	MFM 108	1
G 2	681	MFM 109	1
G 2 1/2	993	MFM 110	1
G 2 1/2	1317	MFM 111	1
G 2 1/2	1750	MFM 112	1
G 3	2039	MFM 113	1
G 3	2549	MFM 114	1
Nivel de filtración : 1 µm			



CARTUCHO PARA FILTRACIÓN DE BASE - FILTRO MICRÓNICO SERIE MFM

Cartucho para filtración de base MFM

T1

Referencia del filtro	Referencia	Emba.
MFM 101	MFMC 101	1
MFM 102	MFMC 102	1
MFM 103	MFMC 103	1
MFM 104	MFMC 104	1
MFM 105	MFMC 105	1
MFM 106	MFMC 106	1
MFM 107	MFMC 107	1
MFM 108	MFMC 108	1
MFM 109	MFMC 109	1
MFM 110	MFMC 110	1
MFM 111	MFMC 111	1
MFM 112	MFMC 112	1
MFM 113	MFMC 113	1
MFM 114	MFMC 114	1



SERIE MFB FILTRO SUBMICRÓNICO

Filtro micrónico MFB - filtro por coalescencia 0.01 µm T1

	Rosca hembra (BSPP)	Caudal (in m³/h a 7 bar)	Referencia	Emba.
	G 1/4	34	MFB 201	1
	G 3/8	59	MFB 202	1
	G 1/2	85	MFB 203	1
	G 3/4	127	MFB 204	1
	G 3/4	175	MFB 205	1
	G 1	267	MFB 206	1
	G 1 1/2	437	MFB 207	1
	G 1 1/2	612	MFB 208	1
	G 2	681	MFB 209	1
	G 2 1/2	993	MFB 210	1
	G 2 1/2	1317	MFB 211	1
	G 2 1/2	1750	MFB 212	1
	G 3	2039	MFB 213	1
	G 3	2549	MFB 214	1
Nivel de filtración : 0,01 µm				

SERIE MFC FILTRO CARBÓN ACTIVADO

Filtración carbón activado MFC T1

	Rosca hembra (BSPP)	Caudal (in m³/H a 7 bar)	Referencia	Emba.
	G 1/4	34	MFC 301	1
	G 3/8	59	MFC 302	1
	G 1/2	85	MFC 303	1
	G 3/4	127	MFC 304	1
	G 3/4	175	MFC 305	1
	G 1	267	MFC 306	1
	G 1 1/2	437	MFC 307	1
	G 1 1/2	612	MFC 308	1
	G 2	681	MFC 309	1
	G 2 1/2	993	MFC 310	1
	G 2 1/2	1317	MFC 311	1
	G 2 1/2	1750	MFC 312	1
	G 3	2039	MFC 313	1
	G 3	2549	MFC 314	1
Filtración y desodoriza el aire comprimido Prever arriba un conjunto MFM - MFB				

CARTUCHO PARA FILTRACIÓN SUBMICRÓNICO - SERIE MFB

Cartucho para filtración submicrónica MFB - filtro por coalescencia : 0.01 µm T1

	Referencia del filtro	Referencia	Emba.
	MFB 201	MFBC 201	1
	MFB 202	MFBC 202	1
	MFB 203	MFBC 203	1
	MFB 204	MFBC 204	1
	MFB 205	MFBC 205	1
	MFB 206	MFBC 206	1
	MFB 207	MFBC 207	1
	MFB 208	MFBC 208	1
	MFB 209	MFBC 209	1
	MFB 210	MFBC 210	1
	MFB 211	MFBC 211	1
	MFB 212	MFBC 212	1
	MFB 213	MFBC 213	1
	MFB 214	MFBC 214	1

CARTUCHO PARA FILTRO CARBÓN ACTIVADO - SERIE MFC

Cartucho para filtración carbón activado MFC T1

	Referencia del filtro	Referencia	Emba.
	MFC 301	MFCC 301	1
	MFC 302	MFCC 302	1
	MFC 303	MFCC 303	1
	MFC 304	MFCC 304	1
	MFC 305	MFCC 305	1
	MFC 306	MFCC 306	1
	MFC 307	MFCC 307	1
	MFC 308	MFCC 308	1
	MFC 309	MFCC 309	1
	MFC 310	MFCC 310	1
	MFC 311	MFCC 311	1
	MFC 312	MFCC 312	1
	MFC 313	MFCC 313	1
	MFC 314	MFCC 314	1

ACCESORIOS Y PIEZAS SUELTAS

Mini purga temporizada para cuba de filtro

T1

	Referencia	Emba.
	Duración de abertura : 2 sec Tensión de alimentación : 220 V - 50/60Hz Funcionamiento : Control de apertura por prueba manual Frecuencia de abertura : 1 a 120 min Dénominación : FAP 18	1
	Referencia : TEMP MN220V	1
Adaptador para montaje en cubetas de filtros G 1/8		

Juego de ensamblaje

T1

Compatibilidad	Referencia	Emba.
Juego de ensamblaje para filtros G 1/4 a G 1/2 (abrazadera + junta)	MPA 1	1
Juego de ensamblaje para filtros G 3/4 a G 1 (abrazadera + junta)	MPA 2	1
Juego de ensamblaje para filtros G 1 1/2 a G 2 (abrazadera + junta)	MPA 3	1
Juego de ensamblaje para filtros G 2 1/2 a G 3 (abrazadera + junta)	MPA 4	1
Junta para juego de ensamblaje MPA 1	MPA J1	1
Junta para juego de ensamblaje MPA 2	MPA J2	1
Junta para juego de ensamblaje MPA 3	MPA J3	1
Junta para juego de ensamblaje MPA 4	MPA J4	1

Juego de conexión rápida en línea

T1

Rosca hembra BSPP	Referencia	Emba.
G 1/2	MTS 103	1

ACCESORIOS Y PIEZAS SUELTAS

Escuadra de fijación

T1

Compatibilidad	Referencia	Emba.
Para filtros : G 1/4 a G 1/2	MPK 1	1
Para filtros : G 3/4 a G 1	MPK 2	1
Para filtros : G 1 1/2 a G 2	MPK 3	1
Para filtros : G 2 1/2 a G 3	MPK 4	1



Pieza suelta : purga automática de flotador

T1

Compatibilidad	Referencia	Emba.
Para filtros : G 1/4 a G 2	MPD	1



Pieza suelta : purga electrónica

T1

Compatibilidad	Referencia	Emba.
Para filtros : G 2 1/2 a G 3	MPD X3	1
Kit de mantenimiento para MPD X3	MPD X3KIT	1



Piezas sueltas : indicador del colmatado

T1

Compatibilidad	Referencia	Emba.
(1) Para filtros : G 1/4 a G 3/4	MPI 1	1
(2) Para filtros : G 1 a G 3	MPI 2	1

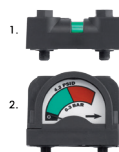

CONJUNTOS DE FILTRADO

Conjunto de filtrado para pistolas de pintura

T1

Entrada rosca hembra BSPP	Salida : 1 enchufe	Referencia	Emba.
G 3/8	ISI 06	MBR 38IS	1
G 3/8	ESI 07	MBR 38ES	1
G 3/8	CSI 06	MBR 38CS	1
G 1/2	ISI 06	MBR 12IS	1
G 1/2	ESI 07	MBR 12ES	1
G 1/2	CSI 06	MBR 12CS	1

Conjunto de filtrado estanco compuesto de :

- 1 filtro micrónico MFM, 1 µm
- 1 filtro submicrónico MFB, 0,01 µm
- 1 regulador con manómetro 0-10 bar (limbo de vidrio)
- 2 fijaciones murales
- 1 enchufe rápido de seguridad prevoS1

Conjunto especial de filtrado para pistolas de pintura :
Pintura de calidad, eliminación de los cráteres de silicona, microburbujas y defectos por residuos.



PINTURA

Conjunto de filtrado para pistolas de pintura en portátil

T1

Entrada rosca hembra BSPP	Salida : 1 enchufe	Referencia	Emba.
G 1/2	ISI 06	PTM BIS	1
G 1/2	ESI 07	PTM BES	1

Conjunto de filtrado estanco compuesto de :

- 1 filtro micrónico MFM, 1 µm
- 1 filtro submicrónico MFB, 0,01 µm
- 1 regulador con manómetro 0 - 10 bar (limbo de vidrio)
- 1 enchufe rápido de seguridad prevoS1
- 1 portátil

Conjunto especial de filtrado para pistolas de pintura :
Pintura de calidad, eliminación de los cráteres de silicona, microburbujas y defectos por residuos.



PINTURA

CONJUNTOS DE FILTRADO

Conjunto de filtrado para pistolas de pintura

T1

Entrada rosca hembra BSPP	Salida : 1 enchufe	Referencia	Emba.
G 1/2	ISI 06	MBC 12IS	1
G 1/2	ESI 07	MBC 12ES	1

Conjunto de filtrado estanco compuesto de :

- 1 filtro micrónico MFM, 1 µm
- 1 filtro submicrónico MFB, 0,01 µm
- 1 filtro carbón activado MFC

Separación de aceite : 0.003 mg/m3

- 2 fijaciones murales
- 1 enchufe de seguridad prevoS1

Conjunto especial de filtrado para pistolas de pintura :
Pintura de calidad, eliminación de los cráteres de silicona, microburbujas y defectos por residuos.



PINTURA

Conjunto de filtrado y regulador para pistolas de pintura

T1

Entrada rosca hembra BSPP	Salida : 2 enchufes	Referencia	Emba.
G 3/8	ISI 06	MBCR 38IS	1
G 3/8	ESI 07	MBCR 38ES	1
G 3/8	CSI 06	MBCR 38CS	1
G 1/2	ISI 06	MBCR 12IS	1
G 1/2	ESI 07	MBCR 12ES	1
G 1/2	CSI 06	MBCR 12CS	1

Conjunto de filtrado estanco compuesto de :

- 1 filtro micrónico MFM, 1 µm
- 1 filtro submicrónico MFB, 0,01 µm
- 1 filtro carbón activado MFC - Separación de aceite : 0.004 mg/m3
- 1 regulador con manómetro 0-10 bar (limbo de vidrio)
- 2 fijaciones murales
- 2 Enchufes de seguridad PrevoS1

Conjunto especial de filtrado para pistolas de pintura :
Pintura de calidad, eliminación de los cráteres de silicona, microburbujas y defectos por residuos.



PINTURA

Conjunto de filtrado y regulador para pistolas de pintura

T1

Entrada rosca hembra BSPP	Salida : 2 enchufes	Referencia	Emba.
G 1/2	ISI 06	PTM CIS	1
G 1/2	ESI 07	PTM CES	1

Conjunto de filtrado estanco compuesto de :

- 1 filtro micrónico MFM, 1 µm
- 1 filtro submicrónico MFB, 0,01 µm
- 1 filtro carbón activado MFC
- 1 regulador con manómetro (limbo de vidrio)
- Separación de aceite : 0.004 mg/m3
- 2 fijaciones murales
- 2 Enchufes de seguridad prevoS1

Conjunto especial de filtrado para pistolas de pintura :
Pintura de calidad, eliminación de los cráteres de silicona, microburbujas y defectos por residuos.



PINTURA

CARTUCHOS PARA FILTROS SUBMICRÓNICOS SERIE PREVOST MAM - MAS - MAC

Cartucho para filtración de base MAM

T1

Referencia del filtro	Referencia	Emba.
MAM 101	MCAM 101	1
MAM 102	MCAM 102	1
MAM 103	MCAM 103	1
MAM 104	MCAM 104	1
MAM 105	MCAM 105	1
MAM 106	MCAM 106	1
MAM 107	MCAM 107	1
MAM 108	MCAM 108	1
MAM 109	MCAM 109	1
MAM 110	MCAM 110	1
MAM 111	MCAM 111	1



CARTUCHO COMPATIBLE PARA FILTROS SUBMICRÓNICOS SERIE FAM - FAS - FAC

Filtración 1 µm

T1

Referencia del filtro	Referencia	Emba.
FAM 101	FCAF 101	1
FAM 102	FCAF 102	1
FAM 103	FCAF 103	1
FAM 104	FCAF 104	1
FAM 105	FCAF 105	1
FAM 106	FCAF 106	1
FAM 107	FCAF 107	1
FAM 108	FCAF 108	1
FAM 109	FCAF 109	1
FAM 110	FCAF 110	1
FAM 111	FCAF 111	1
FAM 112	FCAF 112	1
FAM 114	FCAF 114	1



Cartucho para filtración submicrónico MAS

T1

Referencia del filtro	Referencia	Emba.
MAS 201	MCAM 201	1
MAS 202	MCAM 202	1
MAS 203	MCAM 203	1
MAS 204	MCAM 204	1
MAS 205	MCAM 205	1
MAS 206	MCAM 206	1
MAS 207	MCAM 207	1
MAS 208	MCAM 208	1
MAS 209	MCAM 209	1
MAS 210	MCAM 210	1
MAS 211	MCAM 211	1



Filtración 0,01 µm

T1

Referencia del filtro	Referencia	Emba.
FAS 201	FCAF 201	1
FAS 202	FCAF 202	1
FAS 203	FCAF 203	1
FAS 204	FCAF 204	1
FAS 205	FCAF 205	1
FAS 206	FCAF 206	1
FAS 207	FCAF 207	1
FAS 208	FCAF 208	1
FAS 209	FCAF 209	1
FAS 210	FCAF 210	1
FAS 211	FCAF 211	1
FAS 212	FCAF 212	1
FAS 213	FCAF 213	1
FAS 214	FCAF 214	1



Cartucho para filtración carbón activado MAC

T1

Referencia del filtro	Referencia	Emba.
MAC 301	MCAM 301	1
MAC 302	MCAM 302	1
MAC 303	MCAM 303	1
MAC 304	MCAM 304	1
MAC 305	MCAM 305	1
MAC 306	MCAM 306	1
MAC 307	MCAM 307	1
MAC 308	MCAM 308	1
MAC 309	MCAM 309	1
MAC 310	MCAM 310	1
MAC 311	MCAM 311	1



Filtración carbón activado

T1

Referencia del filtro	Referencia	Emba.
FAC 301	FCAF 301	1
FAC 302	FCAF 302	1
FAC 303	FCAF 303	1
FAC 304	FCAF 304	1
FAC 305	FCAF 305	1
FAC 306	FCAF 306	1
FAC 307	FCAF 307	1
FAC 308	FCAF 308	1
FAC 309	FCAF 309	1
FAC 310	FCAF 310	1
FAC 311	FCAF 311	1



CARTUCHO COMPATIBLE PARA FILTROS SUBMICRONICOS

Filtración 3 µm - Grade V (azul)

T1

Compatibilidad (Creysensac)	Compatibilidad (Zander)	Referencia	Emba.
213061-13	1/1050V	MCAF 13V	1
213062-13	1/1070V	MCAF 17V	1
213063-13	1/1140V	MCAF 21V	1
213064-13	1/2010V	MCAF 27V	1
213065-13	1/2020V	MCAF 34V	1
213046-13	1/2030V	MCAF 491V	1
213066-13	1/2050V	MCAF 492V	1
213067-13	1/3050V	MCAF 601V	1
213068-13	1/3075V	MCAF 602V	1
	1/5075V	MCAF 90V	1



CARTUCHO COMPATIBLE PARA FILTROS SUBMICRONICOS

Filtración 0,01 µm (rojo)

T1

Compatibilidad (Zander)	Compatibilidad (Creysensac)	Referencia	Emba.
1/1050X	213077-13	MCAF 13X	1
1/1070X	213078-13	MCAF 17X	1
1/1140X	213079-13	MCAF 21X	1
1/2010X	213080-13 / 213240-13	MCAF 27X	1
1/2020X	213081-13	MCAF 34X	1
1/2030X	213047-13	MCAF 491X	1
1/2050X	213049-13 / 213243-13	MCAF 492X	1
1/3050X	213082-13 / 213244-13	MCAF 601X	1
1/3075X	213083-13	MCAF 602X	1
1/5075X		MCAF 90X	1



Filtración 1 µm - Grade Z (verde)

T1

Compatibilidad (Zander)	Compatibilidad (Creysensac)	Referencia	Emba.
1/1050Z	213069-13	MCAF 13Z	1
1/1070Z	213070-13	MCAF 17Z	1
1/1140Z	213071-13	MCAF 21Z	1
1/2010Z	213072-13 / 213225-13	MCAF 27Z	1
1/2020Z	213073-13 / 213226-13	MCAF 34Z	1
1/2030Z	213074-13 / 213227-13	MCAF 491Z	1
1/2050Z	213048-13	MCAF 492Z	1
1/3050Z	213075-13 / 213229-13	MCAF 601Z	1
1/3075Z	213076-13	MCAF 602Z	1
1/5075Z		MCAF 90Z	1



Filtración carbón activo - Grade A

T1

Compatibilidad (Zander)	Compatibilidad (Creysensac)	Referencia	Emba.
1/1050A	213084-13	MCAF SA1	1
1/1070A	213085-13	MCAF SA2	1
1/1140A	213086-13	MCAF SA4	1
1/2010A	213087-13	MCAF SA6	1
1/2020A	213088-13 / 213256-13	MCAF SA8	1
1/2030A	213089-13	MCAF SA10	1
1/2050A	213090-13	MCAF SA15	1
1/3050A	213091-13	MCAF SA16	1
1/3075A	213092-13	MCAF SA18	1



CARTUCHO COMPATIBLE PARA FILTROS SUBMICRONICOS

Serie PFD - Filtración 1 µm (azul)

T1

Compatibilidad (Deltech)	Compatibilidad (Creysensac)	Referencia	Emba.
850 PFD	113-471-13	MCAF 101	1
851 PFD	113-472-13	MCAF 102	1
852 PFD	113-473-13	MCAF 103	1
870 PFD	113-474-13	MCAF 104	1
871 PFD	113-475-13	MCAF 105	1
872 PFD	113-476-13	MCAF 106	1
8101 PFD	113-477-13	MCAF 107	1
8102 PFD	113-478-13	MCAF 108	1
8111 PFD	113-480-13	MCAF 109	1
8113 PFD	113-479-13	MCAF 110	1



CARTUCHO COMPATIBLE PARA FILTROS SUBMICRONICOS

Serie 90 - Filtración 0,03mg/m3 - Tipo MF (azul)

T1

Compatibilidad (Ultrafilter)	Referencia	Emba.
MF 02/05	MUF 0205	1
MF 03/05	MUF 0305	1
MF 03/10	MUF 0310	1
MF 04/10	MUF 0410	1
MF 04/20	MUF 0420	1
MF 05/20	MUF 0520	1
MF 05/25	MUF 0525	1
MF 07/25	MUF 0725	1
MF 07/30	MUF 0730	1
MF 10/30	MUF 1030	1
MF 15/30	MUF 1530	1
MF 20/30	MUF 2030	1
MF 30/30	MUF 3030	1
MF 30/50	MUF 3050	1



Serie HFD - Filtración 0,01 µm (rojo)

T1

Compatibilidad (Deltech)	Compatibilidad (Creysensac)	Referencia	Emba.
850 HFD	113-481-13	MCAF 201	1
851 HFD	113-482-13	MCAF 202	1
852 HFD	113-483-13	MCAF 203	1
870 HFD	113-484-13	MCAF 204	1
871 HFD	113-485-13	MCAF 205	1
872 HFD	113-486-13	MCAF 206	1
8101 HFD	113-487-13	MCAF 207	1
8102 HFD	113-488-13	MCAF 208	1
8111 HFD	113-490-13	MCAF 209	1
8113 HFD	113-489-13	MCAF 210	1



Serie 90 - Filtración 0,01 mg/m3 - Tipo SMF (rojo)

T1

Compatibilidad (Ultrafilter)	Referencia	Emba.
SMF 02/05	MUS 0205	1
SMF 03/05	MUS 0305	1
SMF 03/10	MUS 0310	1
SMF 04/10	MUS 0410	1
SMF 04/20	MUS 0420	1
SMF 05/20	MUS 0520	1
SMF 05/25	MUS 0525	1
SMF 07/25	MUS 0725	1
SMF 07/30	MUS 0730	1
SMF 10/30	MUS 1030	1
SMF 15/30	MUS 1530	1
SMF 20/30	MUS 2030	1
SMF 30/30	MUS 3030	1
SMF 30/50	MUS 3050	1



Serie CFD - Filtración carbón activo

T1

Compatibilidad (Deltech)	Compatibilidad (Creysensac)	Referencia	Emba.
850 CFD	113-462-13	MCAF 301	1
853 CFD	113-463-13	MCAF 302	1
854 CFD	113-464-13	MCAF 303	1
873 CFD	113-465-13	MCAF 304	1
874 CFD	113-466-13	MCAF 305	1
875 CFD	113-467-13	MCAF 306	1
8105 CFD	113-468-13	MCAF 307	1
8112 CFD	113-469-13	MCAF 308	1
8121 CFD	113-470-13	MCAF 309	1

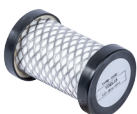

CARTUCHO COMPATIBLE PARA FILTROS SUBMICRONICOS

Serie 90 - Filtración carbón activo - 0,003 ppm - Tipo AK T1

Compatibilidad (Ultrafilter)	Referencia	Emba.
AK 02/05	MUC 0205	1
AK 03/05	MUC 0305	1
AK 03/10	MUC 0310	1
AK 04/10	MUC 0410	1
AK 04/20	MUC 0420	1
AK 05/20	MUC 0520	1
AK 05/25	MUC 0525	1
AK 07/25	MUC 0725	1
AK 07/30	MUC 0730	1
AK 10/30	MUC 1030	1
AK 15/30	MUC 1530	1
AK 20/30	MUC 2030	1
AK 30/30	MUC 3030	1
AK 30/50	MUC 3050	1



CARTUCHO COMPATIBLE PARA FILTROS SUBMICRONICOS

Serie K - Filtración 0,01 µm - 0,01 mg/m3 - Tipo AA (rojo) T1

Compatibilidad (Domnick Hunter)	Referencia	Emba.
K 009 AA	MDA 009	1
K 030 AA	MDA 030	1
K 058 AA	MDA 058	1
K 145 AA	MDA 145	1
K 220 AA	MDA 220	1
K 330 AA	MDA 330	1
K 430 AA	MDA 430	1
K 620 AA	MDA 620	1



CARTUCHO COMPATIBLE PARA FILTROS SUBMICRONICOS

Serie K - Filtración 1 µm - Grade AO (azul) T1

Compatibilidad (Domnick Hunter)	Referencia	Emba.
K 009 AO	MDO 009	1
K 017 AO	MDO 017	1
K 030 AO	MDO 030	1
K 058 AO	MDO 058	1
K 145 AO	MDO 145	1
K 220 AO	MDO 220	1
K 330 AO	MDO 330	1
K 430 AO	MDO 430	1
K 620 AO	MDO 620	1



Serie K - Filtración carbón activo - Grade ACS T1

Compatibilidad (Domnick Hunter)	Referencia	Emba.
K 009 ACS	MDS 009	1
K 017 ACS	MDS 017	1
K 030 ACS	MDS 030	1
K 058 ACS	MDS 058	1
K 145 ACS	MDS 145	1
K 220 ACS	MDS 220	1
K 330 ACS	MDS 330	1
K 430 ACS	MDS 430	1
K 620 ACS	MDS 620	1



CARTUCHO COMPATIBLE PARA FILTROS SUBMICRÓNICOS

Filtración 1 µm - Grade P (azúl)

T1

Compatibilidad (Hiross)	Referencia	Emba.
P 004	MHP 004	1
P 007	MHP 007	1
P 015	MHP 015	1
P 024	MHP 024	1
P 035	MHP 035	1
P 060	MHP 060	1
P 090	MHP 090	1
P 120	MHP 120	1
P 150	MHP 150	1
P 240	MHP 240	1
P 260	MHP 260	1



PURGAS ELÉCTRICAS TEMPORIZADAS

Conjunto de purga temporizada

T1

Entrada rosca macho BSPP	Salida rosca hembra BSPP	Tensión de alimentación	Referencia	Emba.
G 3/8 o G 1/2	G 3/8	220 V - 50/60 Hz	TEMP 38220KIT	1

Conjunto listo para montar compuesto de :

- Un reloj programable
- Una electroválvula de evacuación de condensados
- Un colector de impurezas con válvula aislamiento 1/4 de vuelta
- Una alimentación eléctrica completa, longitud 1,20 m
- Un enchufe rápido Ø 8 mm
- 30 cm de tubo poliuretano Ø 8 mm



Filtración 0,01 µm - Grade S (rojo)

T1

Compatibilidad (Hiross)	Referencia	Emba.
S 007	MHS 007	1
S 015	MHS 015	1
S 024	MHS 024	1
S 035	MHS 035	1
S 060	MHS 060	1
S 090	MHS 090	1
S 120	MHS 120	1
S 150	MHS 150	1
S 240	MHS 240	1
S 260	MHS 260	1



Purga temporizada completa

T1

Entrada rosca macho BSPP	Salida rosca macho BSPP	Tensión de alimentación	Referencia	Emba.
G 1/2	G 3/8	220 V - 50/60 Hz	TEMP 38220COL	1

Conjunto compuesto de :

- Un reloj programable
- Una electroválvula de evacuación de condensados
- Un colector de impurezas con válvula aislamiento 1/4 de vuelta - Ø paso 4.5 mm



Filtración carbón activo - Grade C

T1

Compatibilidad (Hiross)	Referencia	Emba.
C 004	MHC 004	1
C 007	MHC 007	1
C 015	MHC 015	1
C 024	MHC 024	1
C 035	MHC 035	1
C 060	MHC 060	1
C 090	MHC 090	1
C 120	MHC 120	1
C 150	MHC 150	1
C 240	MHC 240	1
C 260	MHC 260	1



Purga temporizada (reloj + electroválvula)

T1

Rosca hembra BSPP	Tensión de alimentación	Referencia	Emba.
G 1/8	220 V AC - 50/60 Hz	TEMP 18220V	1
G 1/4	220 V AC - 50/60 Hz	TEMP 14220V	1
G 3/8	220 V AC - 50/60 Hz	TEMP 38220V	1
G 1/2	220 V AC - 50/60 Hz	TEMP 12220V	1



PURGAS ELÉCTRICAS TEMPORIZADAS

Purga temporizada completa serie económica

T1

Entrada rosca hembra BSPP	Salida rosca macho BSPP	Referencia	Emba.
G 1/2	G 3/8	TEMP 38220COLSE	1

Conjunto compuesto de :
 - Un reloj programable
 - Una electroválvula de evacuación de condensados
 - Un colector de impurezas con válvula aislamiento 1/4 de vuelta

Purga temporizada serie económica

T1

Rosca hembra BSPP	Tensión de alimentación	Referencia	Emba.
G 1/4	220 V - 50/60 Hz	TEMP 14220SE	1
G 3/8	220 V - 50/60 Hz	TEMP 38220SE	1

Mini purga temporizada para cuba de filtro

T1

Referencia	Emba.
TEMP MN220V	1

Duración de apertura : 2 sec
Tensión de alimentación : 220 V - 50/60Hz
Funcionamiento : Control de apertura por prueba manual
Frecuencia de apertura : 1 a 120 min
Dénominación : **FAP 18**

Adaptador para montaje en cubetas de filtros G 1/8

Purga temporizada alta presión

T1

Rosca hembra BSPP	Tensión de alimentación	Presión de uso (bar)	Paso (mm)	Referencia	Emba.
G 1/4	220V-50/60 Hz	0 a 40	2	TEMP 14220HP	1

Purga temporizada calidad alimentaria

T1

Rosca hembra BSPP	Tensión de alimentación	Material	Referencia	Emba.
G 1/4	220 V - 50/60 Hz	Acero inoxidable 304	TEMP 14220INOX	1

PURGAS ELÉCTRICAS TEMPORIZADAS

Piezas sueltas

T1

Dénominación	Entrada rosca hembra BSPP	Tensión de alimentación	Referencia	Emba.
1. Reloj solo	-	24 a 240 V AC/DC	TEMP	1
2. Bobina	-	24V - 50/60 Hz	BOB 24VA	1
2. Bobina	-	48 V - 50/60 Hz	BOB 48VA	1
2. Bobina	-	110V - 50/60 Hz	BOB 110VA	1
2. Bobina 50 Hz corriente alterna Tension estándar 220 V	-	220 V - 50/60 Hz	BOB 220VA	1
3. Electroválvula	G 1/8	-	ELV 18	1
3. Electroválvula	G 1/4	-	ELV 14	1
3. Electroválvula	G 3/8	-	ELV 38	1
3. Electroválvula	G 1/2	-	ELV 12	1
3. Electroválvula alta presión de 0 a 40 bar	G 1/4	-	ELV 14HP	1
3. Electroválvula inox 304 -	G 1/4	-	ELV 14INOX	1
Colector de impurezas con válvula de aislamiento	-	-	COL 1238	1
5. Conector de alimentación	-	-	TEMP CONNECT	1



PURGAS ELÉCTRICAS TEMPORIZADAS

Piezas sueltas para purga serie económica

T1

Dénominación	Rosca hembra BSP	Referencia	Emba.
Reloj solo	-	TEMP SE	1
Electroválvula con bobina 220V	G 1/4	ELV 14SE	1
Electroválvula con bobina 220V	G 3/8	ELV 38SE	1



SEPARADORES DE AGUA

Separador de agua ciclónico con purga de flotador

T1

Rosca hembra (BSP)	Caudal (m3/h)	Referencia	Emba.
G 1/2	155	SPC 155	1
G 3/4	235	SPC 235	1
G 1	365	SPC 365	1
G 1 1/2	770	SPC 770	1
G 2	1280	SPC 1280	1



Purga electrica

T1

	Referencia	Emba.
Entrada rosca macho BSPT : R 1/2	PDE 100	1
Salida Ø : 8 mm		
Capacidad de evacuación : 5 l/h		
Presión de uso : 0,2-16 bar		
Nivel de protección : IP 65		
Tensión de alimentación : 230 V AC		
Temperatura : +1°C a +60°C		
Dénominación : Kit de reparación par purge PDE 100	PDE 100KR	1
Conformidad con la directiva 2014/68/CE relativa a los equipos a presión.		



Escuadra de fijación para separador SPC

T1

NUEVO	Compatibilidad	Referencia	Emba.
	SPC 155 - SPC 235	SPC Q1	1
	SPC 365 - SPC 770 - SPC 1280	SPC Q2	1



Purga para separador SPC

T1

Dénominación	Referencia	Emba.
Purga para separador SPC	SPC D	1



PURGAS MECÁNICAS

Purgador de agua automático

T1

	Referencia	Emba.
	Rosca hembra BSPP : G 1/2 Salida de purga : Ø 8 mm Caudal de purga : 2,5 l/min a 6 bar Presión de uso : 2 - 12 bar	PAM 21 1

Piezas sueltas para PAM 21

T1

Denominación	Referencia	Emba.
	Flotador para purga PAM 21	PAM FLO 1

Purga manual

T1

Rosca macho BSPP	Referencia	Emba.
	G 1/8 G 1/4 G 3/8	MA 18 MA 14 MA 38 1 1 1

PURGA MAGNÉTICA

Purga magnética de evacuación de los contaminantes

T1

NUEVO	Referencia	Emba.
	Entrada rosca hembra BSPP : 2 x G 1/2 Salida rosca hembra BSPP : G 1/8 Evacuación de los condensados : 200l/hora	PMA 201 1
Evacuación automática de los contaminantes gracias a una válvula magnética. A un determinado nivel de agua, el flotador abre la válvula magnética. Una vez evacuada el agua, el flotador vuelve a bajar y cierra la válvula. Purgador sin pérdida de aire. Sin alimentación eléctrica.		

SECADORES POR REFRIGERACIÓN ALTITUDE

Secadores Altitude

T3

Rosca macho BSPP	Caudal (m3/h)	Referencia	Emba.
	G 3/8 G 3/4 G 3/4 G 3/4 G 1 G 1 G 1 G 2 G 2 G 2 G 2 G 2 G 2	30 60 80 100 140 160 240 315 360 470 580 680 820	ALF 30 ALF 60 ALF 80 ALF 100 ALF 140 ALF 161 ALF 240 ALF 315 ALF 360 ALF 470 ALF 580 ALF 680 ALF 820 1 1 1 1 1 1 1 1 1 1 1 1 1
Diseño simple Evacuación de los contaminantes por purga temporizada Garantía de 2 años (cambio estándar bajo reserva del diagnóstico realizado por PREVOST) Alimentación : 220 V - 50 Hz Refrigerante : - ALF 30 a ALF 161 : R134a - ALF 240 a ALF 820 : R407c Presión de entrada : 7 bar Temperatura de entrada : 35°C Temperatura ambiente : 25°C según norma ISO 7183			

SECADORES POR REFRIGERACIÓN CON CONEXIÓN Y FILTRACIÓN

Secadores por refrigeración con conjunto By-pass, tubería y filtro micrónico

T3

Entrada (By-pass)	Salida de aire (Filtro)	Caudal (m3/h)	Referencia	Emba.
	R 1/2M G 3/8H R 3/4M G 1/2H R 3/4 M G 1/2 H R 3/4 M G 3/4 H G 1 H G 3/4 H	30 60 80 100 140	ALF LM30 ALF LM60 ALF LM80 ALF LM100 ALF LM140	1 1 1 1 1

Secadores por refrigeración con conjunto By-pass y tubería

T3

Entrada (by-pass)	Salida de aire (by pass)	Caudal (m3/h)	Referencia	Emba.
	R 1/2M R 1/2M R 3/4M R 3/4M R 3/4M R 3/4M R 3/4M R 3/4M G 1H G 1H	30 60 80 100 140	ALF L30 ALF L60 ALF L80 ALF L100 ALF L140	1 1 1 1 1

CONJUNTO BY-PASS

Conjunto by-pass para instalación de secador

T2

Rosca (BSPP)	Referencia	Emba.
G 1/2 M	MBP 21	1
G 3/4 M	MBP 27	1
G 1 H	MBP 34	1



SECADORES POR ADSORCIÓN KIT DE MANTENIMIENTO

Kit de servicio para secadores Alaska

T3

Compatibilidad	Referencia	Emba.
Para ALC 6 - ALC 10 - ALC 17	ALC 6K12	1
Para ALC 22 - ALC 33	ALC 22K12	1
Para ALC 56 - ALC 77	ALC 56K12	1
Para ALC 121	ALC 121K12	1
Para ALC 183 - ALC 241	ALC 183K12	1

El kit de servicio comprende todas las piezas de recambio para el mantenimiento anual :

- 1 indicador de humedad
- 2 silenciadores
- 2 lanzaderas
- 2 juntas tóricas para lanzadera



SECADORES POR ADSORCIÓN ALASKA

Secadores Alaska

T3

Rosca hembra BSPP	Caudal (entrada m3/h)	Referencia	Emba.
G 1/4	5,9	ALC M6	1
G 1/4	9,7	ALC M10	1
G 1/4	17,5	ALC M17	1
G 1/4	22,4	ALC M22	1
G 3/8	33,4	ALC M33	1
G 1/2	56,1	ALC M56	1
G 1/2	77,4	ALC M77	1
G 3/4	120,9	ALC M121	1
G 1	183,1	ALC M183	1
G 1	241,4	ALC M241	1

Punto de rocío bajo presión : -40 °C
 El aire utilizado por la columna en fase de regeneración representa cerca del 15% del caudal de entrada del secador.
 El caudal de regeneración (Caudal entrada - Caudal salida) debe tenerse en cuenta al elegir el modelo de secador a instalar.
 Garantía de 1 año para los componentes, salvo el desecante
 Caudales expresados para presión de entrada : 7 bar
 T° de entrada : 35 °C
 T° ambiente : 25 °C según norma ISO 7183



Kit de mantenimiento para secadores Alaska

T3

Compatibilidad	Referencia	Emba.
Para ALC 6 - ALC 10	ALC 6K36	1
Para ALC 17	ALC 17K36	1
Para ALC 22	ALC 22K36	1
Para ALC 33	ALC 33K36	1
Para ALC 56	ALC 56K36	1
Para ALC 77	ALC 77K36	1
Para ALC 121	ALC 121K36	1
Para ALC 183	ALC 183K36	1
Para ALC 241	ALC 241K36	1

El juego de mantenimiento contiene todas las piezas de recambio para el mantenimiento después del menor de los plazos de 18000 a 20000 horas de servicio o 3 años :

- 1 indicador de humedad
- 2 silenciadores
- 2 lanzaderas
- 2 cartuchos de adsorción
- 6 juntas tóricas para lanzadera



ACCESORIOS PARA SECADORES

Tubos flexibles de compensación de dilataciones y contracciones de la red - Enchufes macho giratorios

T4

Rosca macho BSPT	Long. (m)	Referencia	Emba.
R 1/2	0,75	LAM 21	1
R 3/4	0,75	LAM 27	1
R 1	0,75	LAM 34	1
R 1 1/4	1,1	LAM 42	1
R 1 1/2	1,25	LAM 49	1
R 2	1	LAM 60	1



Tubos flexibles de enlace - Conexiones hembra giratorias

T4

Rosca hembra BSPP	Long. (m)	Referencia	Emba.
G 3/8	1,5	LEF 17	1
G 1/2	1,5	LEF 21	1
G 3/4	1,5	LEF 27	1
G 1	1,5	LEF 34	1
G 1 1/4	2,2	LEF 42	1
G 1 1/2	2,5	LEF 49	1
G 2	2	LEF 60	1



ACCESORIOS PARA SECADORES

Tubos flexibles de enlace - Conexiones macho giratorias

T4

Rosca macho BSPT	Long. (m)	Referencia	Emba.
R 3/8	1,5	LEM 17	1
R 1/2	1,5	LEM 21	1
R 3/4	1,5	LEM 27	1
R 1	1,5	LEM 34	1
R 1 1/4	2,2	LEM 42	1
R 1 1/2	2,5	LEM 49	1
R 2	2	LEM 60	1



Tubos flexibles de enlace con cable de acero de seguridad - Conexiones hembra giratorias

T4

Rosca hembra BSPP	Long. (m)	Referencia	Emba.
G 3/8	1,5	LEF 17S	1
G 1/2	1,5	LEF 21S	1
G 3/4	1,5	LEF 27S	1
G 1	1,5	LEF 34S	1



Tubos flexibles de enlace con cable de seguridad - Conexiones macho giratorias

T4

Rosca macho BSPT	Long. (m)	Referencia	Emba.
R 3/8	1,5	LEM 17S	1
R 1/2	1,5	LEM 21S	1
R 3/4	1,5	LEM 27S	1
R 1	1,5	LEM 34S	1



Autoservicio



ENCHUFES RÁPIDOS DE SEGURIDAD SOBRE PLACA - ISI 06



Enchufe rosca hembra cilíndrica

T1

Referencia	Emba.	Código de barras
ISI 061101CP Rosca hembra BSPP : G 1/4	1	
ISI 061102CP Rosca hembra BSPP : G 3/8	1	
ISI 061103CP Rosca hembra BSPP : G 1/2	1	

ENCHUFES RÁPIDOS DE SEGURIDAD SOBRE PLACA - ISI 06



Composición enchufe rosca hembra cilíndrica + conector

T1

Referencia	Emba.	Código de barras
REI6 101151P Enchufe : G 1/4 H Conector : R 1/4 M	1	
REI6 101P Enchufe : G 1/4 H Conector : G 1/4 H	1	

Enchufe rosca macho cilíndrica

T1

Referencia	Emba.	Código de barras
ISI 061151CP Rosca macho BSPP : G 1/4	1	
ISI 061152CP Rosca macho BSPP : G 3/8	1	
ISI 061153CP Rosca macho BSPP : G 1/2	1	

Composición enchufe rosca macho cilíndrica + conector + abrazadera de orejas

T1

Referencia	Emba.	Código de barras
REI6 153808P Enchufe : G 1/2 M Conector : para tubo Ø int. 8mm Abrazadera de orejas : 1517	1	

Enchufe para tubo con abrazadera de orejas

T1

Referencia	Emba.	Código de barras
ISI 061806CP Para tubo Ø int. : 6 mm Abrazadera de orejas : 1113	1	
ISI 061808CP Para tubo Ø int. : 8 mm Abrazadera de orejas : 1517	1	
ISI 061810CP Para tubo Ø int. : 10 mm Abrazadera de orejas : 1518	1	
ISI 061813CP Para tubo Ø int. : 13 mm Abrazadera de orejas : 1821	1	

Composición enchufe para tubo + conector + abrazadera de orejas

T1

Referencia	Emba.	Código de barras
REI6 808P Para tubo Ø int. : 8 mm Abrazadera de orejas : 1517 x 2	1	
REI6 810P Para tubo Ø int. : 10 mm Abrazadera de orejas : 1518 x 2	1	

CONECTORES PARA ENCHUFES SOBRE PLACA - IRP 06



2 conectores rosca hembra cilíndrica

T1

Referencia	Emba.	Código de barras
IRP 066101P2 Cantidad : 2 Rosca hembra : G 1/4	1 3	 660058 265317
IRP 066102P2 Cantidad : 2 Rosca hembra : G 3/8	1 3	 660058 232043
IRP 066301P2 Cantidad : 2 Rosca hembra : 1/4 NPSM	1 3	 660058 270946
IRP 066314P2 Cantidad : 2 Rosca hembra : M14 x 1,25	1 3	 660058 270953
IRP 066315P2 Cantidad : 2 Rosca hembra : Devibiss	1 3	 660058 270960



3 conectores rosca hembra cilíndrica

T1

Referencia	Emba.	Código de barras
IRP 066101P3 Cantidad : 3 Rosca hembra BSPP : G 1/4	1 3	 660058 232036



2 conectores rosca macho

T1

Referencia	Emba.	Código de barras
IRP 066151P2 Cantidad : 2 Rosca macho BSPT : R 1/4	1 3	 660058 247672
IRP 066152P2 Cantidad : 2 Rosca macho BSPT : R 3/8	1 3	 660058 232067
IRP 066354P2 Cantidad : 2 Rosca macho BSPT : M14 x 1,25	1 3	 660058 270977



CONECTORES PARA ENCHUFES SOBRE PLACA - IRP 06



3 conectores rosca macho

T1

Referencia	Emba.	Código de barras
IRP 066151P3 Cantidad : 3 Rosca macho BSPT : R 1/4	1 3	 660058 232050



2 conectores para tubo con abrazadera de orejas

T1

Referencia	Emba.	Código de barras
IRP 066806P2 Cantidad : 2 Para tubo Ø int. : 6 mm Abrazadera de orejas : 1113	1 3	 660058 232074
IRP 066808P2 Cantidad : 2 Para tubo Ø int. : 8 mm Abrazadera de orejas : 1517	1 3	 660058 258432
IRP 066810P2 Cantidad : 2 Para tubo Ø int. : 10 mm Abrazadera de orejas : 1518	1 3	 660058 252935
IRP 066813P2 Cantidad : 2 Para tubo Ø int. : 13 mm Abrazadera de orejas : 1821	1 3	 660058 262569
CEI6 808810P Cantidad : 1 Para tubo Ø int. : 8 mm + 10 mm Abrazadera de orejas : 1517 + 1518	1 3	 660058 232111



3 conectores para tubo con abrazadera de orejas

T1

Referencia	Emba.	Código de barras
IRP 066806P3 Cantidad : 3 Para tubo Ø int. : 6 mm Abrazadera de orejas : 1113	1 3	 660058 250092
IRP 066808P3 Cantidad : 3 Para tubo Ø int. : 8 mm Abrazadera de orejas : 1517	1 3	 660058 232081
IRP 066810P3 Cantidad : 3 Para tubo Ø int. : 10 mm Abrazadera de orejas : 1518	1 3	 660058 232098



CONECTORES PARA ENCHUFES SOBRE PLACA - IRP 06



Conjunto de conectores con abrazadera de orejas

T1

Referencia	Emba.	Código de barras
CE16 101151808P Rosca hembra : G 1/4 Rosca macho : R 1/4 Para tubo Ø int. : 8 mm Abrazadera de orejas : 1517	1	 3 660058 232104
CE16 101151810P Rosca hembra : G 1/4 Rosca macho : R 1/4 Para tubo Ø int. : 10 mm Abrazadera de orejas : 1518	1	 3 660058 232128



ESTUCHE DE JUEGO DE ENCHUFES Y CONECTORES

Estuche de juego de enchufes de seguridad y conectores

T1

Referencia	Emba.	Código de barras
BR 600ISP	1	 3 660058 237680
Estuche con : 2 enchufes G 1/4 BSPP hembra - ISI 061101 2 conectores G 1/4 BSPP hembra - IRP 066101 1 conector G 1/4 BSPP hembra con cono de estanqueidad - IRP 066101AE 2 conectores R 1/4 BSPP macho - IRP 066151 2 conectores para tubo Ø 8 mm - IRP 066808 2 empalmes G 1/4 BSPP macho para tubo Ø 8 mm - JFT 1408 2 abrazaderas de orejas - 1315 2 abrazaderas de orejas - 1517		



ENCHUFES RÁPIDOS DE SEGURIDAD SOBRE PLACA - ISI 08



Enchufe rosca hembra cilíndrica

T1

Referencia	Emba.	Código de barras
ISI 081101CP Rosca hembra BSPP : G 1/4	1	 3 660058 248976
ISI 081102CP Rosca hembra BSPP : G 3/8	1	 3 660058 248983
ISI 081103CP Rosca hembra BSPP : G 1/2	1	 3 660058 248990



Enchufe rosca macho cilíndrica

T1

Referencia	Emba.	Código de barras
ISI 081151CP Rosca macho BSPP : G 1/4	1	 3 660058 249003
ISI 081152CP Rosca macho BSPP : G 3/8	1	 3 660058 249010
ISI 081153CP Rosca macho BSPP : G 1/2	1	 3 660058 249027



Enchufe para tubo con abrazadera de orejas

T1

Referencia	Emba.	Código de barras
ISI 081808CP Para tubo Ø int. : 8 mm Abrazadera de orejas : 1517	1	 3 660058 249034
ISI 081810CP Para tubo Ø int. : 10 mm Abrazadera de orejas : 1518	1	 3 660058 249041
ISI 081813CP Para tubo Ø int. : 13 mm Abrazadera de orejas : 1821	1	 3 660058 249058
ISI 081816CP Para tubo Ø int. : 16 mm Abrazadera de orejas : 2225	1	 3 660058 249065



ENCHUFES RÁPIDOS DE SEGURIDAD SOBRE PLACA - ISI 08



Composición enchufe rosca hembra cilíndrico + conector T1

	Referencia	Emba.	Código de barras
	REI8 103151P	1	
	Enchufe : G 1/2 H Conector : R 1/4 M		3 660058 265539

CONECTORES PARA ENCHUFES SOBRE PLACA - IRP 08



Conectores rosca hembra cilíndrica T1

	Referencia	Emba.	Código de barras
	IRP 086101P	1	
	Cantidad : 1 Rosca hembra BSPP : G 1/4		3 660058 252836
	IRP 086102P	1	
Cantidad : 1 Rosca hembra BSPP : G 3/8		3 660058 252843	
IRP 086103P	1		
Cantidad : 1 Rosca hembra BSPP : G 1/2		3 660058 252850	

Composición enchufe rosca macho cilíndrico + conector + abrazadera de orejas T1

	Referencia	Emba.	Código de barras
	REI8 153810P	1	
	Enchufe : G 1/2 M Conector : para tubo Ø int. 10mm Abrazadera de orejas : 1518		3 660058 265485

2 conectores rosca hembra cilíndrica T1

	Referencia	Emba.	Código de barras
	IRP 086101P2	1	
	Cantidad : 2 Entrada rosca hembra BSPP : G 1/4		3 660058 265348
	IRP 086102P2	1	
	Cantidad : 2 Entrada rosca hembra BSPP : G 3/8		3 660058 265355
	IRP 086103P2	1	
	Cantidad : 2 Entrada rosca hembra BSPP : G 1/2		3 660058 265362

Composición enchufe para tubo + conector + abrazadera de orejas T1

	Referencia	Emba.	Código de barras
	REI8 808P	1	
	Para tubo Ø int. : 8 mm Abrazadera de orejas : 1517 x 2		3 660058 265454
	REI8 810P	1	
Para tubo Ø int. : 10 mm Abrazadera de orejas : 1518 x 2		3 660058 265461	
REI8 813P	1		
Para tubo Ø int. : 13 mm Abrazadera de orejas : 1821 x 2		3 660058 265478	

Conectores rosca macho cónico T1

	Referencia	Emba.	Código de barras
	IRP 086151P	1	
	Cantidad : 1 Rosca macho BSPT : R 1/4		3 660058 252867
	IRP 086152P	1	
Cantidad : 1 Rosca macho BSPT : R 3/8		3 660058 252874	
IRP 086153P	1		
Cantidad : 1 Rosca macho BSPT : R 1/2		3 660058 252881	

CONECTORES PARA ENCHUFES SOBRE PLACA - IRP 08

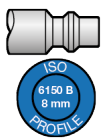

2 conectores rosca macho cónica

T1

	Referencia	Emba.	Código de barras
	IRP 086151P2 Cantidad : 2 Rosca macho BSPT : R 1/4	1	 3 660058 265379
	IRP 086152P2 Cantidad : 2 Rosca macho BSPT : R 3/8	1	 3 660058 265386
	IRP 086153P2 Cantidad : 2 Rosca macho BSPT : R 1/2	1	 3 660058 265393

ENCHUFES RÁPIDOS DE SEGURIDAD SOBRE PLACA - ESI 07



Enchufe rosca hembra cilíndrica

T1

	Referencia	Emba.	Código de barras
	ESI 071101CP Rosca hembra BSPP : G 1/4	1	 3 660058 223454
	ESI 071102CP Rosca hembra BSPP : G 3/8	1	 3 660058 223461
	ESI 071103CP Rosca hembra BSPP : G 1/2	1	 3 660058 223478



Conectores para tubo con abrazadera de orejas

T1

	Referencia	Emba.	Código de barras
	IRP 086808P Cantidad : 1 Para tubo Ø int. : 8 mm Abrazadera de orejas : 1517	1	 3 660058 252898
	IRP 086810P Cantidad : 1 Para tubo Ø int. : 10 mm Abrazadera de orejas : 1518	1	 3 660058 252904
	IRP 086813P Cantidad : 1 Para tubo Ø int. : 13 mm Abrazadera de orejas : 1821	1	 3 660058 252911
	IRP 086816P Cantidad : 1 Para tubo Ø int. : 16 mm Abrazadera de orejas : 2225	1	 3 660058 252928





Enchufe rosca macho cilíndrica

T1

	Referencia	Emba.	Código de barras
	ESI 071151CP Rosca macho BSPP : G 1/4	1	 3 660058 223485
	ESI 071152CP Rosca macho BSPP : G 3/8	1	 3 660058 223492
	ESI 071153CP Rosca macho BSPP : G 1/2	1	 3 660058 223508

2 conectores para tubo con abrazaderas de orejas

T1

	Referencia	Emba.	Código de barras
	IRP 086808P2 Cantidad : 2 Para tubo Ø int. : 8 mm Abrazadera de orejas : 1517	1	 3 660058 265409
	IRP 086810P2 Cantidad : 2 Para tubo Ø int. : 10 mm Abrazadera de orejas : 1518	1	 3 660058 265416
	IRP 086813P2 Cantidad : 2 Para tubo Ø int. : 13 mm Abrazadera de orejas : 1821	1	 3 660058 265423
	IRP 086816P2 Cantidad : 2 Para tubo Ø int. : 16 mm Abrazadera de orejas : 2225	1	 3 660058 265430

Enchufe para tubo con abrazadera de orejas

T1

	Referencia	Emba.	Código de barras
	ESI 071806CP Para tubo Ø int. : 6 mm Abrazadera de orejas : 1113	1	 3 660058 247696
	ESI 071808CP Para tubo Ø int. : 8 mm Abrazadera de orejas : 1517	1	 3 660058 223515
	ESI 071809CP Para tubo Ø int. : 9 mm Abrazadera de orejas : 1517	1	 3 660058 223522
	ESI 071810CP Para tubo Ø int. : 10 mm Abrazadera de orejas : 1518	1	 3 660058 223539
	ESI 071813CP Para tubo Ø int. : 13 mm Abrazadera de orejas : 1821	1	 3 660058 223546

ENCHUFES RÁPIDOS DE SEGURIDAD SOBRE PLACA - ESI 07



Composición enchufe rosca hembra cilíndrica + conector

T1

Referencia	Emba.	Código de barras
REE7 101151P Enchufe : G 1/4 H Conector : R 1/4 M	1	
	3	660058 265560

Composición enchufe rosca macho cilíndrica + conector + abrazadera de orejas

T1

Referencia	Emba.	Código de barras
REE7 153809P Enchufe : G 1/2 M Conector : para tubo Ø int. 9 mm Abrazadera de orejas : 1517	1	
	3	660058 265614

Composición enchufe para tubo + conector + abrazadera de orejas

T1

Referencia	Emba.	Código de barras
REE7 806P Para tubo Ø int. : 6 mm Abrazadera de orejas : 1113 x 2	1	
	3	660058 265577
REE7 809P Para tubo Ø int. : 9 mm Abrazadera de orejas : 1517 x 2	1	
	3	660058 265584
REE7 810P Para tubo Ø int. : 10 mm Abrazadera de orejas : 1518 x 2	1	
	3	660058 265591
REE7 813P Para tubo Ø int. : 13 mm Abrazadera de orejas : 1821 x 2	1	
	3	660058 265607

CONECTORES PARA ENCHUFES SOBRE PLACA - ERP 07



2 conectores rosca hembra cilíndrica

T1

Referencia	Emba.	Código de barras
ERP 076101P2 Cantidad : 2 Rosca hembra BSPP : G 1/4	1	
	3	660058 232135
ERP 076102P2 Cantidad : 2 Rosca hembra BSPP : G 3/8	1	
	3	660058 232142
ERP 076103P2 Cantidad : 2 Rosca hembra BSPP : G 1/2	1	
	3	660058 265492

2 conectores rosca macho conicó

T1

Referencia	Emba.	Código de barras
ERP 076151P2 Cantidad : 2 Rosca macho BSPT : R 1/4	1	
	3	660058 232159
ERP 076152P2 Cantidad : 2 Rosca macho BSPT : R 3/8	1	
	3	660058 232166
ERP 076153P2 Cantidad : 2 Rosca macho BSPT : R 1/2	1	
	3	660058 265522

CONECTORES PARA ENCHUFES SOBRE PLACA - ERP 07



3 conectores rosca macho cilíndrico

T1

	Referencia	Emba.	Código de barras
	ERP 076151P3	1	
	Cantidad : 3		
	Rosca macho BSPT : R 1/4		
		3	660058 265508

CONECTORES PARA ENCHUFES SOBRE PLACA - ERP 07



3 conectores para tubo con abrazaderas de orejas

T1

	Referencia	Emba.	Código de barras
	ERP 076806P3	1	
	Cantidad : 3		
	Para tubo Ø int. : 6 mm		
	Abrazadera de orejas : 1113	3	660058 250214
	ERP 076809P3	1	
	Cantidad : 3		
	Para tubo Ø int. : 9 mm		
	Abrazadera de orejas : 1517	3	660058 265553
ERP 076810P3	1		
Cantidad : 3			
Para tubo Ø int. : 10 mm			
Abrazadera de orejas : 1518	3	660058 250221	
ERP 076813P3	1		
Cantidad : 3			
Para tubo Ø int. : 13 mm			
Abrazadera de orejas : 1821	3	660058 250238	

2 conectores para tubo con abrazaderas de orejas

T1

	Referencia	Emba.	Código de barras
	ERP 076806P2	1	
	Cantidad : 2		
	Para tubo Ø int. : 6 mm		
	Abrazadera de orejas : 1113	3	660058 247689
	ERP 076808P2	1	
	Cantidad : 2		
	Para tubo Ø int. : 8 mm		
	Abrazadera de orejas : 1517	3	660058 232173
ERP 076809P2	1		
Cantidad : 2			
Para tubo Ø int. : 9 mm			
Abrazadera de orejas : 1517	3	660058 265546	
ERP 076810P2	1		
Cantidad : 2			
Para tubo Ø int. : 10 mm			
Abrazadera de orejas : 1518	3	660058 232180	
ERP 076813P2	1		
Cantidad : 2			
Para tubo Ø int. : 13 mm			
Abrazadera de orejas : 1821	3	660058 252959	
CEE7 808810P	1		
Cantidad : 2			
Para tubo Ø int. : 8 mm + 10 mm			
Abrazadera de orejas : 1517 + 1518	3	660058 232203	

Conjunto de conectores con abrazadera de orejas

T1

	Referencia	Emba.	Código de barras
	CEE7 101151808P	1	
	Rosca hembra BSPP : G 1/4		
	Rosca macho BSPT : R 1/4		
	Para tubo Ø int. : 8 mm		
	Abrazadera de orejas : 1315	3	660058 232197
	CEE7 101151809P	1	
	Rosca hembra BSPP : G 1/4		
	Rosca macho BSPT : R 1/4		
	Para tubo Ø int. : 9 mm		
	Abrazadera de orejas : 1517	3	660058 265621
CEE7 101151810P	1		
Rosca hembra BSPP : G 1/4			
Rosca macho BSPT : R 1/4			
Para tubo Ø int. : 10 mm			
Abrazadera de orejas : 1518	3	660058 232210	

ENCHUFES RÁPIDOS DE SEGURIDAD SOBRE PLACA - CSI 06



Enchufe rosca hembra cilíndrica

T1

	Referencia	Emba.	Código de barras
	CSI 061101CP Rosca hembra BSPP : G 1/4	1	
	CSI 061102CP Rosca hembra BSPP : G 3/8	1	
	CSI 061103CP Rosca hembra BSPP : G 1/2	1	

ENCHUFES RÁPIDOS DE SEGURIDAD SOBRE PLACA - CSI 06



Composición enchufe rosca hembra cilíndrica + conector

T1

	Referencia	Emba.	Código de barras
	REC6 101151P Enchufe : G 1/4 H Conector : G 1/4 M	1	
		3	

Enchufe rosca macho cilíndrica

T1

	Referencia	Emba.	Código de barras
	CSI 061151CP Rosca macho BSPP : G 1/4	1	
	CSI 061152CP Rosca macho BSPP : G 3/8	1	
	CSI 061153CP Rosca macho BSPP : G 1/2	1	

Composición enchufe rosca macho cilíndrica + conector + abrazadera de orejas

T1

	Referencia	Emba.	Código de barras
	REC6 153808P Enchufe : G 1/2 M Conector : para tubo Ø int.8 mm Abrazadera de orejas : 1517	1	
		3	

Enchufe para tubo con abrazadera de orejas

T1

	Referencia	Emba.	Código de barras
	CSI 061806CP Para tubo Ø int. : 6 mm Abrazadera de orejas : 1113	1	
	CSI 061808CP Para tubo Ø int. : 8 mm Abrazadera de orejas : 1517	1	
	CSI 061810CP Para tubo Ø int. : 10 mm Abrazadera de orejas : 1518	1	
	CSI 061813CP Para tubo Ø int. : 13 mm Abrazadera de orejas : 1821	1	

Composición enchufe para tubo + conector + abrazadera de orejas

T1

	Referencia	Emba.	Código de barras
	REC6 808P Para tubo Ø int. : 8 mm Abrazadera de orejas : 1517 x 2	1	
		3	
	REC6 810P Para tubo Ø int. : 10 mm Abrazadera de orejas : 1518 x 2	1	
		3	

CONECTORES PARA ENCHUFES SOBRE PLACA - CRP 06



Conectores rosca hembra cilíndrica

T1

Referencia	Emba.	Código de barras
CRP 066101P2 Cantidad : 2 Rosca hembra BSPP : G 1/4	1 3	 660058 232302
CRP 066102P2 Cantidad : 2 Rosca hembra BSPP : G 3/8	1 3	 660058 232326



CONECTORES PARA ENCHUFES SOBRE PLACA - CRP 06



2 conectores para tubo con abrazaderas de orejas

T1

Referencia	Emba.	Código de barras
CRP 066806P2 Cantidad : 2 Para tubo Ø int. : 6 mm Abrazadera de orejas : 1113	1 3	 660058 232319
CRP 066808P2 Cantidad : 2 Para tubo Ø int. : 8 mm Abrazadera de orejas : 1517	1 3	 660058 232289
CEC6 808810P Cantidad : 2 Para tubo Ø int. : 8 mm + 10 mm Abrazadera de orejas : 1517 + 1518	1 3	 660058 232340
CRP 066810P2 Cantidad : 2 Para tubo Ø int. : 10 mm Abrazadera de orejas : 1518	1 3	 660058 232296
CRP 066813P2 Cantidad : 2 Para tubo Ø int. : 13 mm Abrazadera de orejas : 1821	1 3	 660058 265805



2 conectores rosca macho cilíndrica

T1

Referencia	Emba.	Código de barras
CRP 066151P2 Cantidad : 2 Rosca macho BSPP : G 1/4	1 3	 660058 232265
CRP 066152P2 Cantidad : 2 Rosca macho BSPP : G 3/8	1 3	 660058 232272



Conjunto de 3 conectores con abrazadera de orejas

T1

Referencia	Emba.	Código de barras
CEC6 101151808P Rosca hembra BSPP : G 1/4 Rosca macho BSPP : G 1/4 Para tubo Ø int. : 8 mm Abrazadera de orejas : 1517	1 3	 660058 232333
CEC6 101151810P Rosca hembra BSPP : G 1/4 Rosca macho BSPP : G 1/4 Para tubo Ø int. : 10 mm Abrazadera de orejas : 1518	1 3	 660058 232357



ENCHUFES RÁPIDOS DE SEGURIDAD SOBRE PLACA - CSI 08



Enchufe rosca hembra cilíndrica

T1

Referencia	Emba.	Código de barras
CSI 081101CP Rosca hembra BSPP : G 1/4	1	 3 660058 265850
CSI 081102CP Rosca hembra BSPP : G 3/8	1	 3 660058 248891
CSI 081103CP Rosca hembra BSPP : G 1/2	1	 3 660058 248907



ENCHUFES RÁPIDOS DE SEGURIDAD SOBRE PLACA - CSI 08



Composición enchufe rosca hembra cilíndrica + conector



T1

Referencia	Emba.	Código de barras
REC8 103151P Enchufe : G 1/2 H Conector : G 1/4 M	1	 3 660058 265874



Enchufe rosca macho cilíndrica

T1

Referencia	Emba.	Código de barras
CSI 081151CP Rosca macho BSPP : G 1/4	1	 3 660058 265867
CSI 081152CP Rosca macho BSPP : G 3/8	1	 3 660058 248914
CSI 081153CP Rosca macho BSPP : G 1/2	1	 3 660058 248921



Composición enchufe rosca macho + conector + abrazadera de orejas

T1

Referencia	Emba.	Código de barras
REC8 153810P Enchufe : G 1/2 Conector : Ø 10 mm Abrazadera de orejas : 1518	1	 3 660058 265911



Enchufe para tubo con abrazadera de orejas

T1

Referencia	Emba.	Código de barras
CSI 081808CP Para tubo Ø int. : 8 mm Abrazadera de orejas : 1517	1	 3 660058 248938
CSI 081810CP Para tubo Ø int. : 10 mm Abrazadera de orejas : 1518	1	 3 660058 248945
CSI 081813CP Para tubo Ø int. : 13 mm Abrazadera de orejas : 1821	1	 3 660058 248952
CSI 081816CP Para tubo Ø int. : 16 mm Abrazadera de orejas : 2225	1	 3 660058 248969



Composición enchufe para tubo + conector + abrazadera de orejas

T1

Referencia	Emba.	Código de barras
REC8 808P Para tubo Ø int. : 8 mm Abrazadera de orejas : 1517 x 2	1	 3 660058 265881
REC8 810P Para tubo Ø int. : 10 mm Abrazadera de orejas : 1518 x 2	1	 3 660058 265898
REC8 813P Para tubo Ø int. : 13 mm Abrazadera de orejas : 1821 x 2	1	 3 660058 265904



CONECTORES PARA ENCHUFES SOBRE PLACA - CRP 08



Conectores rosca hembra cilíndrica

T1

Referencia	Emba.	Código de barras
CRP 086101P Cantidad : 1 Rosca hembra BSPP : G 1/4	1 3	 660058 252737
CRP 086102P Cantidad : 1 Rosca hembra BSPP : G 3/8	1 3	 660058 252744
CRP 086103P Cantidad : 1 Rosca hembra BSPP : G 1/2	1 3	 660058 252751



Conectores rosca macho cilíndrica

T1

Referencia	Emba.	Código de barras
CRP 086151P Cantidad : 1 Rosca macho BSPP : G 1/4	1 3	 660058 252768
CRP 086152P Cantidad : 1 Rosca macho BSPP : G 3/8	1 3	 660058 252775
CRP 086153P Cantidad : 1 Rosca macho BSPP : G 1/2	1 3	 660058 252782



Conectores para tubo + abrazadera de orejas

T1

Referencia	Emba.	Código de barras
CRP 086808P Cantidad : 1 Para tubo Ø int. : 8 mm Abrazadera de orejas : 1517	1 3	 660058 252799
CRP 086810P Cantidad : 1 Para tubo Ø int. : 10 mm Abrazadera de orejas : 1518	1 3	 660058 252805
CRP 086813P Cantidad : 1 Para tubo Ø int. : 13 mm Abrazadera de orejas : 1821	1 3	 660058 252812
CRP 086816P Cantidad : 1 Para tubo Ø int. : 16 mm Abrazadera de orejas : 2225	1 3	 660058 252829



ENCHUFES INSTANTÁNEOS DE POLÍMERO

Enchufe recto macho cónico - RPD MR

T2

Referencia	Emba.	Código de barras
RPD MR0600P Cantidad : 5 Rosca macho BSPT : R 1/8 Para tubo Ø ext. : 6 mm	1 3	 660058 237161
RPD MR0601P Cantidad : 5 Rosca macho BSPT : R 1/4 Para tubo Ø ext. : 6 mm	1 3	 660058 237178
RPD MR0800P Cantidad : 5 Rosca macho BSPT : R 1/8 Para tubo Ø ext. : 8 mm	1 3	 660058 237185
RPD MR0801P Cantidad : 5 Rosca macho BSPT : R 1/4 Para tubo Ø ext. : 8 mm	1 3	 660058 237192
RPD MR0802P Cantidad : 5 Rosca macho BSPT : R 3/8 Para tubo Ø ext. : 8 mm	1 3	 660058 237208
RPD MR1001P Cantidad : 5 Rosca macho BSPT : R 1/4 Para tubo Ø ext. : 10 mm	1 3	 660058 237215
RPD MR1002P Cantidad : 5 Rosca macho BSPT : R 3/8 Para tubo Ø ext. : 10 mm	1 3	 660058 237222











Material : Latón niquelado

ENCHUFES INSTANTÁNEOS DE POLÍMERO

Codo 90° macho cónico orientable - RPC MR

T2





Referencia	Emba.	Código de barras
RPC MR0400P Cantidad : 5 Rosca macho BSPT : R 1/8 Para tubo Ø ext. : 4 mm	1 3	 660058 237239
RPC MR0401P Cantidad : 5 Rosca macho BSPT : R 1/4 Para tubo Ø ext. : 4 mm	1 3	 660058 237277
RPC MR0600P Cantidad : 5 Rosca macho BSPT : R 1/8 Para tubo Ø ext. : 6 mm	1 3	 660058 237284
RPC MR0601P Cantidad : 5 Rosca macho BSPT : R 1/4 Para tubo Ø ext. : 6 mm	1 3	 660058 237291
RPC MR0800P Cantidad : 5 Rosca macho BSPT : R 1/8 Para tubo Ø ext. : 8 mm	1 3	 660058 237307
RPC MR0801P Cantidad : 5 Rosca macho BSPT : R 1/4 Para tubo Ø ext. : 8 mm	1 3	 660058 237314
RPC MR0802P Cantidad : 5 Rosca macho BSPT : R 3/8 Para tubo Ø ext. : 8 mm	1 3	 660058 237321
RPC MR1001P Cantidad : 5 Rosca macho BSPT : R 1/4 Para tubo Ø ext. : 10 mm	1 3	 660058 237338
Cantidad : 5 Rosca macho BSPT : R 3/8 Para tubo Ø ext. : 10 mm	1 3	 660058 237352



ENCHUFES INSTANTÁNEOS DE POLÍMERO

Unión igual para tubo - RPU ET





T2

Referencia	Emba.	Código de barras
RPU ET0404P Cantidad : 5 Para tubo Ø ext. : 4 mm	1 3	 660058 237123
RPU ET0606P Cantidad : 5 Para tubo Ø ext. : 6 mm	1 3	 660058 237130
RPU ET0808P Cantidad : 5 Para tubo Ø ext. : 8 mm	1 3	 660058 237147
RPU ET1010P Cantidad : 5 Para tubo Ø ext. : 10 mm	1 3	 660058 237154



Codo igual 90° - RPC ET

T2





Referencia	Emba.	Código de barras
RPC ET0404P Cantidad : 5 Para tubo Ø ext. : 4 mm	1 3	 660058 237444
RPC ET0606P Cantidad : 5 Para tubo Ø ext. : 6 mm	1 3	 660058 237451
RPC ET0808P Cantidad : 5 Para tubo Ø ext. : 8 mm	1 3	 660058 237468
RPC ET1010P Cantidad : 5 Para tubo Ø ext. : 10 mm	1 3	 660058 237550



ENCHUFES INSTANTÁNEOS DE POLÍMERO





Y igual - RPY ET

T2

	Referencia	Emba.	Código de barras
	RPY ET0404P Cantidad : 5 Para tubo Ø ext. : 4 mm	1	 3 660058 237406
	RPY ET0606P Cantidad : 5 Para tubo Ø ext. : 6 mm	1	 3 660058 237413
	RPY ET0808P Cantidad : 5 Para tubo Ø ext. : 8 mm	1	 3 660058 237420
	RPY ET1010P Cantidad : 4 Para tubo Ø ext. : 10 mm	1	 3 660058 237437

T igual - RPT ET

T2

	Referencia	Emba.	Código de barras
	RPT ET0404P Cantidad : 5 Para tubo Ø ext. : 4 mm	1	 3 660058 237369
	RPT ET0404P Cantidad : 5 Para tubo Ø ext. : 6 mm	1	 3 660058 237376
	RPT ET0808P Cantidad : 5 Para tubo Ø ext. : 8 mm	1	 3 660058 237383
	RPT ET1010P Cantidad : 4 Para tubo Ø ext. : 10 mm	1	 3 660058 237390

CORTATUBOS SOBRE PLACA

Cortatubos - R22 CT





T2

	Referencia	Emba.	Código de barras
	R22 CTP	1	 3 660058 236454

UNIONES PARA TUBO SOBRE PLACA

Enchufes en Y rosca hembra cilíndrica









T2

	Referencia	Emba.	Código de barras
	Y14P2 Cantidad : 2 Rosca hembra BSPP : G 1/4	1	 3 660058 232807
	Y38P2 Cantidad : 2 Rosca hembra BSPP : G 3/8	1	 3 660058 232821
	Y12P2 Cantidad : 2 Rosca hembra BSPP : G 1/2	1	 3 660058 232814

UNIONES PARA TUBO SOBRE PLACA

Uniones rosca macho cónico

T2

Referencia	Emba.	Código de barras
JFT 1406P2 Cantidad : 2 Rosca macho BSPT : R 1/4 Para tubo Ø int. : 6 mm	1 3	 660058 232401
JFT 1408P2 Cantidad : 2 Rosca macho BSPT : R 1/4 Para tubo Ø int. : 8 mm	1 3	 660058 232418
JFT 1410P2 Cantidad : 2 Rosca macho BSPT : R 1/4 Para tubo Ø int. : 10 mm	7,20 1 3	 660058 232425
JFT 1412P2 Cantidad : 2 Rosca macho BSPT : R 1/4 Para tubo Ø int. : 12 mm	1 3	 660058 232500
JFT 3808P2 Cantidad : 2 Rosca macho BSPT : R 3/8 Para tubo Ø int. : 8 mm	1 3	 660058 232456
JFT 3810P2 Cantidad : 2 Rosca macho BSPT : R 3/8 Para tubo Ø int. : 10 mm	1 3	 660058 232449
JFT 3812P2 Cantidad : 2 Rosca macho BSPT : R 3/8 Para tubo Ø int. : 12 mm	1 3	 660058 232463
JFT 1212P2 Cantidad : 2 Rosca macho BSPT : R 1/2 Para tubo Ø int. : 12 mm	1 3	 660058 232487
JFT 1216P2 Cantidad : 2 Rosca macho BSPT : R 1/2 Para tubo Ø int. : 16 mm	1 3	 660058 232494



UNIONES PARA TUBO SOBRE PLACA

Tetónes doble rosca macho cónico - A2

T2

Referencia	Emba.	Código de barras
A2 1414P2 Cantidad : 2 Rosca macho BSPT : R 1/4 x R 1/4	1 3	 660058 232531
A2 1438P2 Cantidad : 2 Rosca macho BSPT : R 1/4 x R 3/8	1 3	 660058 232555
A2 1412P2 Cantidad : 2 Rosca macho BSPT : R 1/4 x R 1/2	1 3	 660058 232586
A2 3838P2 Cantidad : 2 Rosca macho BSPT : R 3/8 x R 3/8	1 3	 660058 232562
A2 3812P2 Cantidad : 2 Rosca macho BSPT : R 3/8 x R 1/2	1 3	 660058 232579
A2 1212P2 Cantidad : 2 Rosca macho BSPT : R 1/2 x R 1/2	1 3	 660058 232548
A2 3434P2 Cantidad : 2 Rosca macho BSPT : R 3/4 x R 3/4	1 3	 660058 232593



Uniones doble





T2

Referencia	Emba.	Código de barras
JDT 0606P2 Cantidad : 2 Para tubo Ø int. : 6 mm	1 3	 660058 232784
JDT 0808P2 Cantidad : 2 Para tubo Ø int. : 8 mm	1 3	 660058 232760
JDT 1010P2 Cantidad : 2 Para tubo Ø int. : 10 mm	1 3	 660058 232777
JDT 1212P2 Cantidad : 2 Para tubo Ø int. : 12 mm	1 3	 660058 232791



Manguitos iguales rosca hembra cilíndrica - A3

T2

Referencia	Emba.	Código de barras
A3 14P2 Cantidad : 2 Rosca hembra BSPP : G 1/4	1 3	 660058 232609
A3 38P2 Cantidad : 2 Rosca hembra BSPP : G 3/8	1 3	 660058 232623
A3 12P2 Cantidad : 2 Rosca hembra BSPP : G 1/2	1 3	 660058 232630
A3 34P2 Cantidad : 2 Rosca hembra BSPP : G 3/4	1 3	 660058 232708



UNIONES PARA TUBO SOBRE PLACA

Reducciones rosca macho cónico/hembra cilíndrica - A4 T2

Referencia	Emba.	Código de barras
A4 3814P2 Cantidad : 2 Rosca hembra BSPP : G 1/4 Rosca macho BSPT : R 3/8	1	 3 660058 232722
A4 1214P2 Cantidad : 2 Rosca hembra BSPP : G 1/4 Rosca macho BSPT : R 1/2	1	 3 660058 232746
A4 1238P2 Cantidad : 2 Rosca hembra BSPP : G 3/8 Rosca macho BSPT : R 1/2	1	 3 660058 232739
A4 3412P2 Cantidad : 2 Rosca hembra BSPP : G 1/2 Rosca macho BSPT : R 3/4	1	 3 660058 232753

Codos rosca macho cónico/hembra cilíndrica - A10 T2





Referencia	Emba.	Código de barras
A10 1414P2 Cantidad : 2 Rosca hembra BSPP : G 1/4 Rosca macho BSPT : R 1/4	1	 3 660058 232838
A10 3838P2 Cantidad : 2 Rosca hembra BSPP : G 3/8 Rosca macho BSPT : R 3/8	1	 3 660058 232852
A10 1212P2 Cantidad : 2 Rosca hembra BSPP : G 1/2 Rosca macho BSPT : R 1/2	1	 3 660058 232845

T igual rosca hembra cilíndrica - A11 T2

Referencia	Emba.	Código de barras
A11 14P2 Cantidad : 2 Rosca hembra BSPP : G 1/4	1	 3 660058 232869
A11 38P2 Cantidad : 2 Rosca hembra BSPP : G 3/8	1	 3 660058 232876
A11 12P Cantidad : 1 Rosca hembra BSPP : G 1/2	1	 3 660058 233859

UNIONES PARA TUBO SOBRE PLACA

Forros T2

Referencia	Emba.	Código de barras
FOU 1417P2 Cantidad : 2 Rosca hembra BSPP : G 1/4 Rosca macho BSPP : G 3/8	1	 3 660058 232890
FOU 1421P2 Cantidad : 2 Rosca hembra BSPP : G 1/4 Rosca macho BSPP : G 1/2	1	 3 660058 232920
FOU 1721P2 Cantidad : 2 Rosca hembra BSPP : G 3/8 Rosca macho BSPP : G 1/2	1	 3 660058 232975
FOU 2127P2 Cantidad : 2 Rosca hembra BSPP : G 1/2 Rosca macho BSPP : G 3/4	1	 3 660058 232913

PRODUCTOS DE ESTANQUEIDAD SOBRE PLACA

Producto de estanqueidad T2

Referencia	Emba.	Código de barras
ETANCHE 177P Peso : 50 g	1	 3 660058 233255

Rodillos de cinta teflón T2

Referencia	Emba.	Código de barras
TEFLON 12P3	1	 3 660058 233163
Rodillo de 12 metros Anchura : 12 mm Grueso : 0.08 mm		

ENCHUFES PARA CIRCUITOS DE AGUA SOBRE PLACA

Enchufe rosca hembra de paso libre

T1

	Referencia	Emba.	Código de barras
	ELS 090103P Rosca hembra BSPP : G 1/2	1	3 660058 233033
	ELS 090104P Rosca hembra BSPP : G 3/4	1	3 660058 233026

Enchufe rosca macho de paso libre

T1

	Referencia	Emba.	Código de barras
	ELS 090153P Rosca macho BSPP : G 1/2	1	3 660058 233088
	ELS 090154P Rosca macho BSPP : G 3/4	1	3 660058 233071

Enchufe para tubo de paso libre

T1

	Referencia	Emba.	Código de barras
	ELS 090813P Para tubo Ø int. : 13 mm	1	3 660058 270823
	ELS 090815P Para tubo Ø int. : 15 mm	1	3 660058 233057
	ELS 090819P Para tubo Ø int. : 19 mm	1	3 660058 233040

Enchufe rosca hembra de obturación

T1

	Referencia	Emba.	Código de barras
	ELS 091103P Rosca hembra BSPP : G 1/2	1	3 660058 232982
	ELS 091104P Rosca hembra BSPP : G 3/4	1	3 660058 232999

ENCHUFES PARA CIRCUITOS DE AGUA SOBRE PLACA

Enchufe rosca macho de obturación

T1

	Referencia	Emba.	Código de barras
	ELS 091153P Rosca macho BSPP : G 1/2	1	3 660058 233064
	ELS 091154P Rosca macho BSPP : G 3/4	1	3 660058 233095

Enchufe para tubo de obturación

T1

	Referencia	Emba.	Código de barras
	ELS 091813P Para tubo Ø int. : 13 mm	1	3 660058 270830
	ELS 091815P Para tubo Ø int. : 15 mm	1	3 660058 233019
	ELS 091819P Para tubo Ø int. : 19 mm	1	3 660058 233002

CONECTORES PARA CIRCUITOS DE AGUA SOBRE PLACA

Conector rosca hembra

T1

	Referencia	Emba.	Código de barras
	ELP 096103P Rosca hembra BSPP : G 1/2	1	3 660058 233118
	ELP 096104P Rosca hembra BSPP : G 3/4	1	3 660058 233125

CONECTORES PARA CIRCUITOS DE AGUA SOBRE PLACA

Conector rosca macho

T1

Referencia	Emba.	Código de barras
ELP 096153P Rosca macho BSPP : G 1/2	1	
	3	660058 233132
ELP 096154P Rosca macho BSPP : G 3/4	1	
	3	660058 233149

Conector para tubos

T1

Referencia	Emba.	Código de barras
ELP 096813P Para tubo Ø int. : 13 mm	1	
	3	660058 270991
ELP 096815P Para tubo Ø int. : 15 mm	1	
	3	660058 233101
ELP 096819P Para tubo Ø int. : 19 mm	1	
	3	660058 233156

Conector doble de enlace para enchufes

T1

Referencia	Emba.	Código de barras
ELP 096002P	1	
	3	660058 270793

Conector triple de enlace para enchufes

T1

Referencia	Emba.	Código de barras
ELP 096003P	1	
	3	660058 270809

VÁLVULAS DE MANGUITO ESFÉRICO SOBRE PLACA

Válvulas latón hembra/hembra

T2

Referencia	Emba.	Código de barras
RSI 21P Rosca hembra BSPP : G 1/2 Presión máx de uso : 40 bar	1	
	3	660058 270847
RSI 27P Rosca hembra BSPP : G 3/4 Presión máx de uso : 40 bar	1	
	3	660058 270854

Miniválvulas mariposa hembra/hembra

T2

Referencia	Emba.	Código de barras
FSI 13P Rosca hembra BSPP : G 1/4	1	
	3	660058 232944
FSI 17P Rosca hembra BSPP : G 3/8	1	
	3	660058 232951
FSI 21P Rosca hembra BSPP : G 1/2	1	
	3	660058 232968

TUBOS EN ESPIRAL DE POLIURETANO CON ENCHUFES SOBRE PLACA

tubo en espiral de poliuretano : equipado con enchufe macho fijo y rotativo

T2

Referencia	Emba.	Código de barras
PUS 52P Diámetro : 5 x 8 mm Connector : R 1/4 Long. : 2 m	1	
	3	660058 233217
PUS 54P Diámetro : 5 x 8 mm Connector : R 1/4 Long. : 4 m	1	
	3	660058 233224
PUS 64P Diámetro : 6,5 x 10 mm Connector : R 1/4 Long. : 4 m	1	
	3	660058 233231
PUS 66P Diámetro : 6,5 x 10 mm Connector : R 1/4 Long. : 6 m	1	
	3	660058 233248
Azul		

PISTOLAS DE SOPLADO PREVO S1 SOBRE PLACA - PERFIL ISO 6150 B



Pistola de soplado prevoS1 con boquilla metálica -
Modelo estándar

T2

Referencia	Emba.	Código de barras
IBG 06MTLP Conector : ISO 6150 B Consumo de aire : 20 Nm3/h Nivel de sonido : 89 dB(A)	1	
	3	660058 262835

Pistola de soplado prevoS1 con boquilla metálica
OSHA - Modelo estándar

T2

Referencia	Emba.	Código de barras
IBG 06MTLHP Conector : ISO 6150 B Consumo de aire : 13 Nm3/h Nivel de sonido : 85 dB(A)	1	
	3	660058 263986

Pistola de soplado prevoS1 con boquilla OSHA -
Modelo estándar

T2

Referencia	Emba.	Código de barras
IBG 060SHP Conector : ISO 6150 B Consumo de aire : 13 Nm3/h Nivel de sonido : 87 dB(A)	1	
	3	660058 262897

Pistola de soplado prevoS1 con boquilla OSHA -
Modelo pocket

T2

Referencia	Emba.	Código de barras
IPG 060SHP Conector : ISO 6150 B Consumo de aire : 14 Nm3/h Nivel de sonido : 89 dB(A)	1	
	3	660058 262958

PISTOLAS DE SOPLADO PREVO S1 SOBRE PLACA - PERFIL ISO 6150 B



Pistola de soplado y enchufe rápido prevoS1 con
abrazadera 2 orejas

T2

Referencia	Emba.	Código de barras
RIBG 06MTLP Composición : 1 pistola : IBG 06MTL 1 enchufe : ISI 061808 1 abrazadera de orejas : 1517	1	
	3	660058 269780
RIBG 06MTLHP Composición : 1 pistola : IBG 06MTLH 1 enchufe : ISI 061808 1 abrazadera de orejas : 1517	1	
	3	660058 269834
RIBG 060SHP Composición : 1 pistola : IBG 060SH 1 enchufe : ISI 061808 1 abrazadera de orejas : 1517	1	
	3	660058 269766
RIBG 06MTL101P Composición : 1 pistola : IBG 06MTL 1 enchufe : ISI 061101	1	
	3	660058 270601
RIBG 06MTL810P Composición : 1 pistola : IBG 06MTL 1 enchufe : ISI 061810 1 abrazadera de orejas : 1518	1	
	3	660058 270595

Pistola de soplado y enchufe rápido prevoS1 con
abrazadera 2 orejas - Modelo pocket

T2

Referencia	Emba.	Código de barras
RIPG 060SHP Composición : 1 pistola : IPG 060SH 1 enchufe : ISI 061808 1 abrazadera de orejas : 1517	1	
	3	660058 269858

Pistola de soplado prevo S1 con soporte de fijación mural

T2

Referencia	Emba.	Código de barras
FIBG 06MTLP Boquilla : metálica MTL Consumo de aire : 20 Nm3/h Nivel de sonido : 89 dB(A)	1	
	3	660058 269551
FIBG 06MTLHP Boquilla : metálica MTL OSHA Consumo de aire : 13 Nm3/h Nivel de sonido : 85 dB(A)	1	
	3	660058 269568
FIBG 060SHP Boquilla : compuesto OSHA Consumo de aire : 13 Nm3/h Nivel de sonido : 87 dB(A)	1	
	3	660058 269544

PISTOLAS DE SOPLADO PREVO S1 SOBRE PLACA - PERFIL EUROPEAN 7,4MM



Pistola de soplado prevoS1 con boquilla metálica -
Modelo estándar

T2

Referencia	Emba.	Código de barras
EBG 07MTLP Conector : European 7,4 mm Consumo de aire : 20 Nm3/h Nivel de sonido : 89 dB(A)	1	 3 660058 262842

Pistola de soplado prevoS1 con boquilla metálica
OSHA - Modelo estándar

T2

Referencia	Emba.	Código de barras
EBG 07MTLHP Conector : European 7,4 mm Consumo de aire : 13 Nm3/h Nivel de sonido : 85 dB(A)	1	 3 660058 263993

Pistola de soplado prevoS1 con boquilla OSHA -
Modelo estándar

T2

Referencia	Emba.	Código de barras
EBG 07OSH Conector : European 7,4 mm Consumo de aire : 13 Nm3/h Nivel de sonido : 87 dB(A)	1	 3 660058 262903

Pistola de soplado prevoS1 con boquilla OSHA -
Modelo pocket

T2

Referencia	Emba.	Código de barras
EPG 07OSH Conector : European 7,4 mm Consumo de aire : 14 Nm3/h Nivel de sonido : 89 dB(A)	1	 3 660058 262965

PISTOLAS DE SOPLADO PREVO S1 SOBRE PLACA - PERFIL EUROPEAN 7,4MM



Pistola de soplado y enchufe rápido prevoS1 con
abrazadera 2 orejas

T2

Referencia	Emba.	Código de barras
REBG 07MTLP Composición : 1 pistola : EBG 07MTL 1 enchufe : ESI 071808 1 abrazadera de orejas : 1517	1	 3 660058 269896
REBG 07MTLHP Composición : 1 pistola : EBG 07MTLH 1 enchufe : ESI 071808 1 abrazadera de orejas : 1517	1	 3 660058 269612
REBG 07OSH Composición : 1 pistola : EBG 07OSH 1 enchufe : ESI 071808 1 abrazadera de orejas : 1517	1	 3 660058 269889

Pistola de soplado y enchufe rápido prevoS1 con
abrazadera 2 orejas - Modelo pocket

T2

Referencia	Emba.	Código de barras
REPG 07OSH Composición : 1 pistola : EPG 07OSH 1 enchufe : ESI 071808 1 abrazadera de orejas : 1517	1	 3 660058 269636

Pistola de soplado prevo S1 con soporte de fijación mural

T2

Referencia	Emba.	Código de barras
FEBG 07MTLP Boquilla : metálica MTL Consumo de aire : 20 Nm3/h Nivel de sonido : 89 dB(A)	1	 3 660058 269582
FEBG 07MTLHP Boquilla : metálica MTL OSHA Consumo de aire : 13 Nm3/h Nivel de sonido : 85 dB(A)	1	 3 660058 269599
FEBG 07OSH Boquilla : compuesto OSHA Consumo de aire : 13 Nm3/h Nivel de sonido : 87 dB(A)	1	 3 660058 269575

PISTOLAS DE SOPLADO PREVO S1 SOBRE PLACA - PERFIL ISO 6150 C



Pistola de soplado prevoS1 con boquilla metálica -
Modelo estándar

T2

Referencia	Emba.	Código de barras
CBG 06MTLP Conector : ISO 6150 C Consumo de aire : 20 Nm3/h Nivel de sonido : 89 dB(A)	1	
	3	660058 262866



Pistola de soplado prevoS1 con boquilla OSHA -
Modelo estándar

T2

Referencia	Emba.	Código de barras
CBG 060SHP Conector : ISO 6150 C Consumo de aire : 13 Nm3/h Nivel de sonido : 87 dB(A)	1	
	3	660058 262927



Pistola de soplado prevoS1 con boquilla OSHA -
Modelo pocket

T2

Referencia	Emba.	Código de barras
CPG 060SHP Conector : ISO 6150 C Consumo de aire : 14 Nm3/h Nivel de sonido : 89 dB(A)	1	
	3	660058 262989



PISTOLAS DE SOPLADO PREVO S1 SOBRE PLACA - PERFIL ISO 6150 C



Pistola de soplado y enchufe rápido prevoS1 con
abrazadera 2 orejas

T2

Referencia	Emba.	Código de barras
RCBG 06MTLP Composición : 1 pistola : CBG 06MTL 1 enchufe : CSI 061808 1 abrazadera de orejas : 1517	1	
	3	660058 269674
RCBG 060SHP Composición : 1 pistola : CBG 060SH 1 enchufe : CSI 061808 1 abrazadera de orejas : 1517	1	
	3	660058 269650
RCBG 06MTL101P Composición : 1 pistola : CBG 06MTL 1 enchufe : CSI 061101	1	
	3	660058 270625
RCBG 06MTL810P Composición : 1 pistola : CBG 06MTL 1 enchufe : CSI 061810 1 abrazadera de orejas : 1518	1	
	3	660058 270618



Pistola de soplado y enchufe rápido prevoS1 con
abrazadera 2 orejas - Modelo pocket

T2

Referencia	Emba.	Código de barras
RCPG 060SHP Composición : 1 pistola : CPG 060SH 1 enchufe : CSI 061808 1 abrazadera de orejas : 1517	1	
	3	660058 269698



Pistola de soplado prevo S1 con soporte de fijación mural

T2

Referencia	Emba.	Código de barras
FCBG 06MTLP Boquilla : metálica MTL Consumo de aire : 20 Nm3/h Nivel de sonido : 89 dB(A)	1	
	3	660058 269629
FCBG 060SHP Boquilla : compuesto OSHA Consumo de aire : 13 Nm3/h Nivel de sonido : 87 dB(A)	1	
	3	660058 269605



PISTOLA DE SOPLADO 27102 SOBRE PLACA

Pistola de soplado con boquilla metálica

T2

Referencia	Emba.	Código de barras
27102 MTLP	1	
Rosca hembra BSPP : G 1/4		
Consumo de aire : 23 Nm ³ /h - 6 bar		
Nivel de sonido : 83 dBA - 6 bar		
	3	660058 231961

PISTOLA DE SOPLADO 27102 SOBRE PLACA

Pistola de soplado con boquilla OSHA con efecto Venturi

T2

Referencia	Emba.	Código de barras
27102 OSHP	1	
Rosca hembra BSPP : G 1/4		
Consumo de aire : 13 Nm ³ /h - 6 bar		
Nivel de sonido : 90 dBA - 6 bar		
	3	660058 253444

Pistola de soplado con boquilla recta antirrayaduras

T2

Referencia	Emba.	Código de barras
27102 PREP	1	
Rosca hembra BSPP : G 1/4		
Consumo de aire : 15 Nm ³ /h - 6 bar		
Nivel de sonido : 84 dBA - 6 bar		
	3	660058 231978

ACCESORIOS PARA PISTOLAS DE SOPLADO PREVO S1 Y 27102

Soporte de fijación mural para pistolas de soplado
prevoS1 y 27102

T2

Referencia	Emba.	Código de barras
BG FIXP	1	
Centros defijación : 70 mm		
	3	660058 266826

Pistola de soplado con boquilla silenciosa

T2

Referencia	Emba.	Código de barras
27102 SILP	1	
Rosca hembra BSPP : G 1/4		
Consumo de aire : 12 Nm ³ /h - 6 bar		
Nivel de sonido : 77 dBA - 6 bar		
	3	660058 253451

CONJUNTOS DE SOPLADO SOBRE PLACA

Pistola de soplado con pantalla de aire protectora

T2

Referencia	Emba.	Código de barras
27102 ECRP	1	
Rosca hembra BSPP : G 1/4		
Consumo de aire : 27 Nm ³ /h - 6 bar		
Nivel de sonido : 82 dBA - 6 bar		
	3	660058 253437

Conjunto de soplado poliuretano

T2

Referencia	Emba.	Código de barras
HELICOL 6P	1	
Rosca macho BSPT : R 1/4		
Long. : 2 m		
Equipado con : 1 pistola de soplado 27102 MTL		
1 tubo en espiral de poliuretano PUS 52		
	3	660058 270984
HELICOL 7P	1	
Rosca macho BSPT : R 1/4		
Long. : 4 m		
Equipado con : 1 pistola de soplado 27102 MTL		
1 tubo en espiral de poliuretano PUS 54		
	3	660058 236423

ABRAZADERAS DE 2 OREJAS

Abrazaderas de orejas tipo estándar acero tratado

T5

Referencia	Emba.	Código de barras
0709P Cantidad : 10 Ø min./máx. : 7-9 mm	1	 3 660058 237079
0911P Cantidad : 10 Ø min./máx. : 9-11 mm	1	 3 660058 237499
1113P Cantidad : 10 Ø min./máx. : 11-13 mm	1	 3 660058 240123
1315P Cantidad : 10 Ø min./máx. : 13-15 mm	1	 3 660058 237741
1517P Cantidad : 10 Ø min./máx. : 14-17 mm	1	 3 660058 270717
1518P Cantidad : 10 Ø min./máx. : 15-18 mm	1	 3 660058 237765
1720P Cantidad : 10 Ø min./máx. : 17-20 mm	1	 3 660058 237086
1821P Cantidad : 10 Ø min./máx. : 18-21 mm	1	 3 660058 237093
2023P Cantidad : 5 Ø min./máx. : 20-23 mm	1	 3 660058 237109
2225P Cantidad : 5 Ø min./máx. : 22-25 mm	1	 3 660058 270724
2327P Cantidad : 5 Ø min./máx. : 23-27 mm	1	 3 660058 237116















ABRAZADERAS DE 2 OREJAS

Abrazaderas de 2 orejas Inox - Acero inoxidable 340L

T5

Referencia	Emba.	Código de barras
INOX 0709P Cantidad : 10 Ø min./máx. : 7-9 mm	1	 3 660058 270861
INOX 0911P Cantidad : 10 Ø min./máx. : 9-11 mm	1	 3 660058 270878
INOX 1113P Cantidad : 10 Ø min./máx. : 11-13 mm	1	 3 660058 270885
INOX 1315P Cantidad : 10 Ø min./máx. : 13-15 mm	1	 3 660058 270892
INOX 1518P Cantidad : 10 Ø min./máx. : 15-18 mm	1	 3 660058 270908
INOX 1720P Cantidad : 10 Ø min./máx. : 17-20 mm	1	 3 660058 270915
Cantidad : 5 Ø min./máx. : 20-23 mm	1	 3 660058 270922
INOX 2327P Cantidad : 5 Ø min./máx. : 23-27 mm	1	 3 660058 270939

ABRAZADERAS DE TORNILLO DE CINTA

Abrazaderas tipo estándar - Cinta de 9 mm

T5



Referencia	Emba.	Código de barras
PBS9 814P Cantidad : 5 Ø min./máx. : 8-14 mm	1	
PBS9 1117P Cantidad : 5 Ø min./máx. : 11-17 mm	1	
PBS9 1320P Cantidad : 5 Ø min./máx. : 13-20 mm	1	
PBS9 1524P Cantidad : 5 Ø min./máx. : 15-24 mm	1	
PBS9 1928P Cantidad : 5 Ø min./máx. : 19-28 mm	1	
PBS9 2232P Cantidad : 4 Ø min./máx. : 22-32 mm	1	



PROTECTORES DE ABRAZADERAS DE OREJAS SOBRE PLACA

Protector de caucho para enchufe

T1

Referencia	Emba.	Código de barras
ECP S11417P Para tubo Ø ext. : 14-17 mm	1	
ECP S11720P Para tubo Ø ext. : 17-20 mm	1	



ABRAZADERAS TIPO MINI Y TIPO MICRO

Serie Mini (acero electrolvanizado) - Cinta de 9 mm

T5

Referencia	Emba.	Código de barras
PBM 11P Cantidad : 5 Ø min./máx. : 9-11 mm	1	
PBM 12P Cantidad : 5 Ø min./máx. : 9-12 mm	1	
PBM 13P Cantidad : 5 Ø min./máx. : 10-13 mm	1	
PBM 14P Cantidad : 5 Ø min./máx. : 11-14 mm	1	
PBM 15P Cantidad : 5 Ø min./máx. : 12-15 mm	1	



PISTOLAS DE INFLADO SOBRE PLACA

Pistola de inflado

T2

Referencia	Emba.	Código de barras
27151P Rosca hembra BSPP : G 1/4 Longitud del tubo : 0,5 m	1	



PISTOLAS DE LAVADO MULTIFUNCIÓN

Pistola de lavado

T2





Referencia	Emba.	Código de barras
PM JETP Rosca hembra BSPP : G 1/2 Caudal : 50 l/min a 12 bar Presión máx de uso : 12 bar Temperatura : 50°C Material : Pistola de lavado de polipropileno y fibra de vidrio, revestida de poliamida protectora PA 66	1	 3 660058 271127



PISTOLAS DE PINTURA HVLP

Pistola de pintura HVLP por succión

T2

Referencia	Emba.	Código de barras
CAR S031HVLP Ø boquilla : 1 mm	1	 3 660058 041386
CAR S032HVLP Ø boquilla : 1,4 mm	1	 3 660058 041393
CAR S033HVLP Ø boquilla : 1,7 mm	1	 3 660058 041379
CAR S033HVLP Ø boquilla : 2 mm	1	 3 660058 041409
CAR S034HVLP Ø boquilla : 2,3 mm	1	 3 660058 041416



Cuerpo de aluminio verde anodizado
 Copa 1 litro de aluminio por oxidación anódica
 Copa de cierre rápido de tipo "estribo", antigoteo
 Gama de presión para una pulverización óptima : de 2 a 3 bar
 Peso : 1,00 kg
 Caudal de aire : 390 l/min a 3 bar
 Enchufe : G 1/4 M
 Enchufe en la copa : G 3/8

PISTOLAS PARA CIRCUITOS DE AGUA

Pistola de lavado industrial

T2

Referencia	Emba.	Código de barras
PL JETP Rosca hembra BSPP : G 1/2 Caudal : 60 l/min a 24 bar Presión máx de uso : 24 bar Temperatura : 90°C Material : Pistola latón envenado poliamida Equipado con : Enchufe giratorio arco de protección de la gatillo	1	 3 660058 271141



Pistola de pintura HVLP por gravedad

T2

Referencia	Emba.	Código de barras
CAR G041HVLP Ø boquilla : 1 mm	1	 3 660058 041430
CAR G04HVLP Ø boquilla : 1,4 mm	1	 3 660058 041423
CAR G042HVLP Ø boquilla : 1,5 mm	1	 3 660058 041447
CAR G043HVLP Ø boquilla : 1,7 mm	1	 3 660058 041454
CAR G044HVLP Ø boquilla : 2 mm	1	 3 660058 041461



Cuerpo de aluminio verde anodizado
 Copa 0,6 litro de poliamida
 Gama de presión para una pulverización óptima : de 2 a 3 bar
 Peso : 1,00 kg
 Caudal de aire : 364 l/min a 4 bar
 Enchufe : G 1/4 M
 Enchufe en la copa : M16 x 1,5 P

PISTOLAS DE PINTURA

Pistola de pintura por aspiración para trabajos técnicos T2

Referencia	Emba.	Código de barras
CAR S031 Ø boquilla : 1,5 mm	1	 3 660058 037495
CAR S03 Ø boquilla : 2 mm	1	 3 660058 032926
CAR S032 Ø boquilla : 2,5 mm	1	 3 660058 037501
 <p>Cuerpo de aluminio azul anodizado Copa 1 litro de aluminio por oxidación anódica Copa de cierre rápido de tipo "estribo", antigoteo Presión de servicio : 3,5 a 5 bar Peso : 0,95 kg Caudal de aire : 260 a 340 l/min Enchufe : G 1/4 M Enchufe en la copa : G 3/8</p>		

PISTOLAS DE PINTURA

Pistola de pintura por gravedad para trabajos técnicos T2

Referencia	Emba.	Código de barras
CAR G04 Ø boquilla : 1,4 mm	1	 3 660058 032940
CAR G041 Ø boquilla : 1,7 mm	1	 3 660058 037150
CAR G042 Ø boquilla : 2 mm	1	 3 660058 037655
 <p>Cuerpo de aluminio azul anodizado Ajuste del caudal de aire comprimido Aguja y boquilla de acero inoxidable Copa 0,6 litro de poliamida Presión de servicio : 3,5 a 5 bar Caudal de aire : 250 a 320 l/min Peso : 0,6 kg Enchufe : G 1/4 M Enchufe en la copa : M16 x 1.5 P</p>		

Pistola de pintura por aspiración para trabajos industriales T2

Referencia	Emba.	Código de barras
CAR S021 Ø boquilla : 1 mm	1	 3 660058 037518
CAR S02 Ø boquilla : 1,6 mm	1	 3 660058 032933
CAR S022 Ø boquilla : 1,8 mm	1	 3 660058 037525
CAR S023 Ø boquilla : 2 mm	1	 3 660058 037532
 <p>Cuerpo de aluminio azul anodizado Copa 1 litro de aluminio por oxidación anódica Boquilla de acero inoxidable Peso : 1,1 kg Caudal de aire : 280 a 360 l/min con 3 bar Presión de servicio : 3,5 a 5 bar Enchufe : G 1/4 M Enchufe en la copa : G 3/8 M</p>		

Pistola de pintura para retoques de carrocería y barnizado para trabajos de decoración T2

Referencia	Emba.	Código de barras
CAR G051 Ø boquilla : 0,5 mm	1	 3 660058 037662
CAR G05 Ø boquilla : 0,8 mm	1	 3 660058 032957
CAR G052 Ø boquilla : 1 mm	1	 3 660058 037679
 <p>Cuerpo de aluminio azul anodizado Copa 0,125 litro de poliamida Presión de servicio : 2,6 a 4 bar Caudal de aire : 85 a 140 l/min Peso : 0,3 kg Enchufe : G 1/4 M Enchufe en la copa : M16 x 1.5 P</p>		

PISTOLAS PARA PINTURA DE BASE ACUOSA

Pistola de pintura HVLP para pintura de base acuosa

T2

Referencia	Emba.	Código de barras
CAR G04HVW Ø boquilla : 1,3 mm	1	 3 660058 238496
<p>Cuerpo de aluminio Copa 0.6 litro Aguja y boquilla de acero inoxidable Presión para una pulverización óptima : 2 bar Presión max. : 3 bar Caudal de aire : 285 l/min a 3 bar Peso : 0,450 kg Enchufe : G 1/4 M Enchufe en la copa : M 16 x 1,5 P</p>		

GAMA ALTO 1 - MODULOS G 1/8 - G 1/4

ALTO 1 - Filtro

T1

Referencia	Emba.	Código de barras
KTF 1 Rosca hembra BSPP : G 1/4 Caudal : 800 l/min a 6 bar $\Delta p=0.3bar$ Filtración : 25 μm	1	 3 660058 270731
<p>Presión max. de uso : 12 bar</p>		

Pistola LVLP para pintura de base acuosa

T2

Referencia	Emba.	Código de barras
CAR G04LVW Ø boquilla : 1,3 mm	1	 3 660058 238502
<p>Cuerpo de aluminio Copa 0.6 litro de aluminio por oxidación anódica Aguja y boquilla de acero inoxidable Presión para una pulverización óptima : 2 bar Caudal de aire : 230 l/min a 2 bar Peso : 0,450 kg Enchufe : G 1/4 M Enchufe en la copa : M 16 x 1,5 P</p>		

ALTO 1 - Regulador

T1

Referencia	Emba.	Código de barras
KTR 1 Rosca hembra BSPP : G 1/4 Caudal : 600 l/min a 7 bar $\Delta p=1bar$ Presión de uso : Entrada : 15 baR Salida : 0,5-10 bar	1	 3 660058 270755
<p>Tamaño conector manómetro : G 1/8</p>		

Pistola de pintura HVLP por succión

T2

Referencia	Emba.	Código de barras
CAR G05HVW Ø boquilla : 1,0 mm	1	 3 660058 238519
<p>Cuerpo de aluminio Copa 0,125 litro de poliamida Aguja y boquilla de acero inoxidable Gama de presión para una pulverización óptima : de 2 a 3 bar Caudal de aire : 112 l/min a 3 bar Peso : 0,280 kg (pistola) + 0,64 Kg (copa) Enchufe : G 1/4 M Enchufe en la copa : M 16 x 1,5 P</p>		

ALTO 1 - Lubricador

T1

Referencia	Emba.	Código de barras
KTL 1 Rosca hembra BSPP : G 1/4 Caudal : 1350 l/min a 6 bar $\Delta p=0,5bar$	1	 3 660058 270779
<p>Presión max. de uso : 12 bar</p>		

GAMA ALTO 1 - G 1/8 - G 1/4 CONJUNTOS EN CAJA

ALTO 1 - Filtro regulador lubricador 2 bloques con manómetro y fijación

T1

Referencia	Emba.	Código de barras
KTB SMO Rosca hembra BSPP : G 1/8 Caudal : 500 l/min a 7 bar $\Delta p=1$ bar Filtración : 25 μ m	1	 3 660058 239677
KTB SM1 Rosca hembra BSPP : G 1/4 Caudal : 500 l/min a 7 bar $\Delta p=1$ bar Filtración : 25 μ m	1	 3 660058 182119
Equipado con un manómetro : 0 a 10 bar Presión máx. de uso : 12 bar		



GAMA ALTO 1 - G 1/8 - G 1/4 CONJUNTOS EN CAJA

ALTO 1 - Filtro regulador con manómetro y fijación

T1

Referencia	Emba.	Código de barras
KTM SMO Rosca hembra BSPP : G 1/8 Caudal : 550 l/min a 7 bar $\Delta p=1$ bar Filtración : 25 μ m	1	 3 660058 239660
KTM SM1 Rosca hembra BSPP : G 1/4 Caudal : 550 l/min a 7 bar $\Delta p=1$ bar Filtración : 25 μ m	1	 3 660058 182140
Equipado con un manómetro : 0 a 10 bar Presión máx. de uso : 12 bar		



ALTO 1 - Filtro regulador lubricador 2 bloques con manómetro y fijación con enchufe de seguridad prevoS1

T1

Referencia	Emba.	Código de barras
KTB SM1IS Rosca hembra BSPP : G 1/4 Provisto de 1 enchufe : ISI 06	1	 3 660058 238120
KTB SM1ES Rosca hembra BSPP : G 1/4 Provisto de 1 enchufe : ESI 07	1	 3 660058 266222
Equipado con un manómetro : 0 a 10 bar Presión máx. de uso : 12 bar		



ALTO 1 - Filtro regulador con manómetro y fijación con enchufe de seguridad prevoS1

T1

Referencia	Emba.	Código de barras
KTM SM1IS Rosca hembra BSPP : G 1/4 Provisto de 1 enchufe : ISI 06	1	 3 660058 238113
KTM SM1ES Rosca hembra BSPP : G 1/4 Provisto de 1 enchufe : ESI 07	1	 3 660058 266253
Equipado con un manómetro : 0 a 10 bar Presión máx. de uso : 12 bar		



GAMA ALTO 1 - ACCESORIOS SOBRE PLACA DE PLÁSTICO G 1/4

Distanciador de salida

T1

Referencia	Emba.	Código de barras
TE 1P Rosca hembra BSPP : G 1/4	1	
4 salidas para aire no lubricado		

ALTO 1 - Juego de ensamblaje y de fijación mural

T1

Referencia	Emba.	Código de barras
TA S1P	1	
1 juego TA S1 para 2 modulos G 1/4 2 juegos TA S1 para 3 modulos G 1/4		



ALTO 1 - Juego de ensamblaje y fijación mural

T1

Referencia	Emba.	Código de barras
TC S1P Rosca hembra BSPP : G 1/4	1	

ALTO 1 - Escuadra de fijación

T1

Referencia	Emba.	Código de barras
TP Q1P 1. Dénominación : Para filtro o lubricador G 1/4	1	
TR QE1P 2. Dénominación : Escuadra para regulador o filtro regulador G 1/4 Tuerca para escuadra de regulador	1	

Cartucho filtrante para filtro y micro filtro ALTO 1

T1

Referencia	Emba.	Código de barras
TF C1P3 Cantidad : 3 Filtración : 25 µm	1	
TF C105P3 Cantidad : 3 Filtración : 5 µm	1	
TF C105101P Cantidad : 2 Filtración : 5 µm y 0.01 µm	1	

GAMA ALTO 2 - MODULOS G 3/8

ALTO 2 - Filtro

T1

Referencia	Emba.	Código de barras
KTF 2 Rosca hembra BSPP : G 3/8 Caudal : 2250 l/min a 6 bar $\Delta p=0.3\text{bar}$ Filtración : 25 µm	1	
Presión max. de uso : 12 bar		

ALTO 2 - Regulador

T1

Referencia	Emba.	Código de barras
KTR 2 Rosca hembra BSPP : G 3/8 Caudal : 2500 l/min a 7 bar $\Delta p=1\text{bar}$ Presión de uso : Entrada : 15 bar Salida : 0-10 bar Tamaño conector manómetro : G 1/8	1	

ALTO 2 - Lubricador

T1

Referencia	Emba.	Código de barras
KTL 2 Rosca hembra BSPP : G 3/8 Caudal : 3000 l/min a 6 bar $\Delta p=0.5\text{bar}$	1	
Presión max. de uso : 12 bar		

GAMA ALTO 2 CONJUNTOS EN CAJA G 3/8

ALTO 2 - Filtro regulador lubricador 2 bloques con manómetro y fijación

T1

Referencia	Emba.	Código de barras
KTB SM2 Rosca hembra BSPP : G 3/8 Caudal : 1250 l/min a 7 bar $\Delta p=1$ bar Filtración : 25 μ m	1	
Equipado con un manómetro : 0 a 10 bar Presión máx. de uso : 12 bar		

ALTO 2 - Filtro regulador lubricador 2 bloques con manómetro y fijación con enchufe de seguridad prevoS1

T1

Referencia	Emba.	Código de barras
KTB SM2IS Rosca hembra BSPP : G 3/8 Provisto de 1 enchufe : ISI 06	1	
KTB SM2ES Rosca hembra BSPP : G 3/8 Provisto de 1 enchufe : ESI 07	1	
Equipado con un manómetro : 0 a 10 bar Presión máx. de uso : 12 bar		



ALTO 2 - Filtro regulador con manómetro y fijación

T1

Referencia	Emba.	Código de barras
KTM SM2 Rosca hembra BSPP : G 3/8 Caudal : 1800 l/min a 7 bar $\Delta p=1$ bar Filtración : 25 μ m	1	
Equipado con un manómetro : 0 a 10 bar Presión máx. de uso : 12 bar		

ALTO 2 - Filtro regulador con manómetro y fijación con enchufe de seguridad prevoS1

T1

Referencia	Emba.	Código de barras
KTM SM2IS Rosca hembra BSPP : G 3/8 Provisto de 1 enchufe : ISI 06	1	
KTM SM2ES Rosca hembra BSPP : G 3/8 Provisto de 1 enchufe : ESI 07	1	
Equipado con un manómetro : 0 a 10 bar Presión máx. de uso : 12 bar		

GAMA ALTO 2 ACCESORIOS SOBRE PLACA G 3/8

ALTO 2 - Distanciador de salida

T1

Referencia	Emba.	Código de barras
TE 2P Rosca hembra BSPP : G 3/8	1	
4 salidas para aire no lubricado		

ALTO 2 - Juego de ensamblaje y de fijación mural

T1

Referencia	Emba.	Código de barras
TA S2P Dénominación : 1 juego TA S1 para 2 módulos G 3/8 2 juegos TA S1 para 3 módulos G 3/8	1	



ALTO 2 - Juego de ensamblaje y fijación mural

T1

Referencia	Emba.	Código de barras
TC S2P Rosca hembra BSPP : G 3/8	1	



Cartucho filtrante para filtro ALTO 2

T1

Referencia	Emba.	Código de barras
TF C2P2 Cantidad : 2 Filtración : 25 μ m	1	
TF C205P2 Cantidad : 2 Filtración : 5 μ m	1	

ALTO 2 - Escuadra de fijación

T1

Referencia	Emba.	Código de barras
TP Q2P 1. Dénominación : Para filtro o lubricador G 3/8	1	
TR QE2P 2. Dénominación : Escuadra para regulador o filtro regulador G 3/8 Tuerca para escuadra de regulador	1	

GAMA ALTO 3 - MODULOS G 1/2

ALTO 3 - Filtro

T1

Referencia	Emba.	Código de barras
KTF 3 Rosca hembra BSPP : G 1/2 Caudal : 3500 l/min a 6 bar $\Delta p=0.3\text{bar}$ Filtración : 25 μm	1	 3 660058 270748
Presión max. de uso : 12 bar		



ALTO 3 - Regulador

T1

Referencia	Emba.	Código de barras
KTR 3 Rosca hembra BSPP : G 1/2 Caudal : 4 000 l/min a 7 bar $\Delta p=1\text{b}$ Presión de uso : Entrada : 15 bar Salida : 0.5 - 10 bar	1	 3 660058 270762
Tamaño conector manómetro : G 1/8		



ALTO 3 - Lubricador

T1

Referencia	Emba.	Código de barras
KTL 3 Rosca hembra BSPP : G 1/2 Caudal : 5650 l/min a 6 bar $\Delta p=0,5\text{bar}$	1	 3 660058 270786
Presión max. de uso : 12 bar		



GAMA ALTO 3 CONJUNTOS EN CAJA G 1/2

ALTO 3 - Filtro regulador lubricador 2 bloques con manómetro y fijación

T1

Referencia	Emba.	Código de barras
KTB SM3 Rosca hembra BSPP : G 1/2 Caudal : 2800 l/min a 7 bar $\Delta p=1\text{bar}$ Filtración : 25 μm	1	 3 660058 184359
Equipado con un manómetro : 0 a 10 bar Presión máx. de uso : 12 bar		



ALTO 3 - Filtro regulador lubricador 2 bloques con manómetro y fijación con enchufe de seguridad prevoS1

T1

Referencia	Emba.	Código de barras
KTB SM3IS Rosca hembra BSPP : G 1/2 Provisto de 1 enchufe : ISI 06	1	 3 660058 199322
KTB SM3ES Rosca hembra BSPP : G 1/2 Provisto de 1 enchufe : ESI 07	1	 3 660058 266246
Equipado con un manómetro : 0 a 10 bar Presión máx. de uso : 12 bar		



ALTO 3 - Kit con un filtro micrónico, regulador y manómetro

T1

Referencia	Emba.	Código de barras
KTB CSM3 Rosca hembra BSPP : G 1/2 Caudal : 1500 l/min a 6 bar $\Delta p=0.3\text{bar}$ Filtración : 5 y 0,01 μm	1	 3 660058 237048
Kit compuesto con 2 etapas para aplicación sin aceite Equipado con un manómetro (limbo de vidrio) : 0 a 10 bar Presión máx. de uso : 12 bar		



PINTURA

GAMA ALTO 3 CONJUNTOS EN CAJA G 1/2

ALTO 3 - Kit con un filtro micrónico, regulador y manómetro con enchufe de seguridad prevoS1

T1

Referencia	Emba.	Código de barras
KTB CSM3IS Rosca hembra BSPP : G 1/2 Filtración : 5 y 0,01 µm Provisto de 1 enchufe : ISI 06	1	3 660058 185417
KTB CSM3ES Rosca hembra BSPP : G 1/2 Filtración : 5 y 0,01 µm Provisto de 1 enchufe : ESI 07	1	3 660058 184373

Equipado con un manómetro (limbo de vidrio) : 0 a 10 bar
Presión máx. de uso : 12 bar



PINTURA

ALTO 3 - Filtro regulador con manómetro y fijación

T1

Referencia	Emba.	Código de barras
KTM SM3 Rosca hembra BSPP : G 1/2 Caudal : 3000 l/min a 7 bar Δp=1bar Filtración : 25 µm	1	3 660058 184380

Equipado con un manómetro : 0 a 10 bar
Presión máx. de uso : 12 bar



ALTO 3 - Filtro regulador con manómetro y fijación con enchufe de seguridad prevoS1

T1

Referencia	Emba.	Código de barras
KTM SM3IS Rosca hembra BSPP : G 1/2 Provisto de 1 enchufe : ISI 06	1	3 660058 238144
KTM SM3ES Rosca hembra BSPP : G 1/2 Provisto de 1 enchufe : ESI 07	1	3 660058 266284

Equipado con un manómetro : 0 a 10 bar
Presión máx. de uso : 12 bar



GAMA ALTO 3 - ACCESORIOS SOBRE PLACAS DE PLÁSTICO G 1/2

ALTO 3 - Distanciador de salida

T1

Referencia	Emba.	Código de barras
TE 3P Rosca hembra BSPP : G 1/2	1	3 660058 237598

4 salidas para aire no lubricado



ALTO 3 - Escuadra de fijación

T1

Referencia	Emba.	Código de barras
TP Q3P 1. Dénominación : Para filtro o lubricador G 1/2	1	3 660058 266055
TR QE3P 2. Dénominación : Escuadra para regulador o filtro regulador G 1/2 Tuerca para escuadra de regulador	1	3 660058 266093



ALTO 3 - Juego de ensamblaje y fijación mural

T1

Referencia	Emba.	Código de barras
TC S3P Rosca hembra BSPP : G 1/2	1	3 660058 237604



ALTO 3 - Juego de ensamblaje y de fijación mural

T1

Referencia	Emba.	Código de barras
TA S3P Dénominación : 1 juego TA S3 para 2 módulos G 1/2 2 juegos TA S3 para 3 módulos G 1/2	1	3 660058 266130



Cartucho filtrante para filtro y micro filtro ALTO 3

T1

Referencia	Emba.	Código de barras
TF C3P Filtración : 25 µm	1	3 660058 266192
TF C305P Filtración : 5 µm	1	3 660058 266208
TF C301P Filtración : 0.01 µm	1	3 660058 266215



MANÓMETROS SOBRE PLACA

Manómetro caja cuadrada 40 x 40 mm

T1

Referencia	Emba.	Código de barras
MT CA1040P Presión de uso : 0 - 10 bar	1	 3 660058 236584
Fijación dorsal preestanca G 1/8 BSPP Limbo de plexiglass		

Manómetro caja redonda Ø 40 mm

T1

Referencia	Emba.	Código de barras
MT RA1040P Presión de uso : 0 - 10 bar	1	 3 660058 236805
MT RA1640P Presión de uso : 0 - 16 bar	10,05 1	 3 660058 236829
Fijación dorsal preestanca G 1/8 BSPP Limbo de plexiglass		

Manómetro integrable con collarín redondo Ø 40 mm

T1

Referencia	Emba.	Código de barras
MT IA1040VP Presión de uso : 0 - 10 bar	1	 3 660058 236812
Fijación dorsal preestanca G 1/8 BSPP Limbo de vidrio compatible con solventes Ø 40 mm		

LUBRICADOR DE LÍNEA SOBRE PLACA

Lubricador de línea

T1

Referencia	Emba.	Código de barras
LUBAIR 14FP Rosca hembra BSPP : Entrada et salida : G 1/4 Aplicaciones : Lubricador para herramientas	1	 3 660058 236430



TEU 18S

Este documento no tiene valor contractual.
Para ofrecer el mejor servicio a sus clientes,
la sociedad PREVOST se reserva la posibilidad de modificar
las características de su gama sin previo aviso.
Publicación Prevost - 11-2017