

LOXEAL®

ENGINEERING ADHESIVES



ISO 9001 / ISO 14001 Registered Company

Technical Information
www.loxeal.com

Edition 2013

Who We Are

Loxéal® Engineering Adhesives is an Italian Company specialized in the manufacturing of a comprehensive range of Technically Advanced Adhesives and Sealants providing since over 30 years solutions to a wide variety of industrial uses.

The Company Quality System certified since 1993 has been maintained and improved along the time granting the high quality level of our products.

Our Anaerobic, Cyanoacrylate, Epoxy, Structural Acrylic, UV-light curing, Polyurethane Adhesives and other Complementary Products have been recognized to perform at the highest requirements.

Selected products have been tested by worldwide accredited Laboratories and certified according to regulations in the field of gas sealing, potable water, medical devices.

Loxéal modern facilities are built in compliance with Safety and Environment Regulations.

We are proud to offer on worldwide basis a great technical support to our Customers thanks to the original technical know-how and qualified and motivated staff.

Certifications and Approvals



Production Facilities Loxéal Italy - 20811 Cesano Maderno, MB - 20020 Misinto, MI

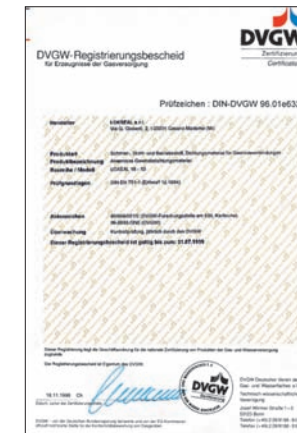

Branch Offices & Warehouses

Loxéal USA Pottstown, PA



Loxéal China Shanghai



Loxéal Spagna Madrid



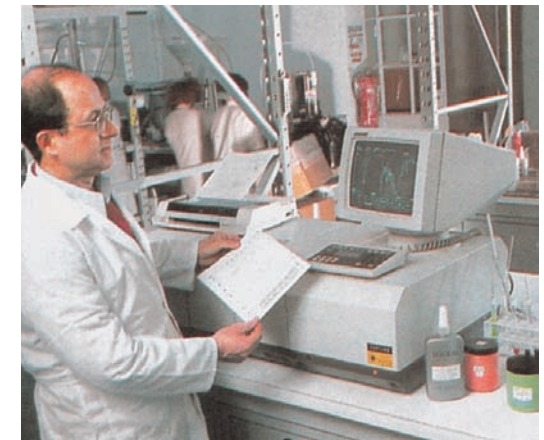

Research & Development



Quality Assurance



Loxal chemical plants largely automated and designed to grant low environment impact, low hazard risk and high quality products. In-house complete manufacturing cycle, from R&D to final packing, allows monitoring of any production step, opening the opportunity to rapidly formulate customer tailored products. Quality, Flexibility, Professional Job are some of the distinctive features of the philosophy "Made in Loxal".



ANAEROBIC ADHESIVES

Anaerobic adhesives are liquid resins polymerising when placed between two close fitting metal surfaces. The adhesive fills all microscopic crevices of the metal surfaces providing better stress distribution on the full joint surface. The cured adhesive gives an excellent seal against water, gas, oils, industrial fluids and chemicals. The fixture time is influenced by the gap between the surfaces, the kind of metal, surface treatments and temperature. Cure speed can vary from a few minutes to over an hour. The operating temperature range is between -55 / +150 °C up to +250°C for special grades.



INSTANT ADHESIVES

Cyanoacrylate adhesives are designed for the rapid bonding of rubber, metals, ceramic, leather, wood, and many plastics. It is recommended that surfaces to bond fit together tightly; best results can be obtained with joint gaps less than 0.1 mm up to 0.2 mm. The operating temperature range is between -50 / +80°C up to +160°C for special grades. The alkoxy-ethyl formulation is designed for no-blooming and low odour purposes.



EPOXY ADHESIVES

Two-part epoxies provide high strength structural joints. Suitable for bonding metals, ceramics, concrete, wood and some plastics, packed in practical two pack cartridges. Curing occurs by reaction of the two components when mixed (resin and hardener). Fixture time from 5-10 mins. to several hours depending on the grade. Heating speeds up the cure. Operating temperature is between -40 and +120°C. Single part epoxy are cured by heating at 130 / 180°C for 10 / 30 minutes. Temperature resistance is up to 200°C.



SILICONE GREASE

Silicone greases are waterproof, suitable for use in contact with potable water and food. They are resistant for use with temperatures up to +200°C, provide low friction coefficients between metals, rubber, plastics and do not cause rubber gaskets to swell.



UV CURING ADHESIVES

UV-curable adhesives set in seconds by irradiation with ultraviolet or visible light, forming a solid adhesive film that does not turn yellow over time. These adhesives are designed to bond glass, crystal, metal and some plastics. Special grades are designed for bonding medical devices. The operating temperature range is -50 / +120°C.

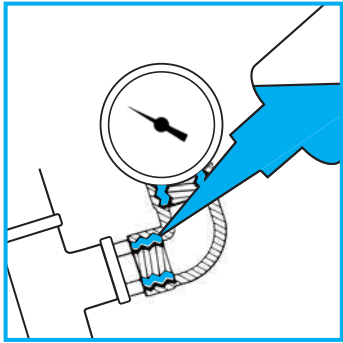

ThreadSealing

Anaerobic threadsealing adhesives seal and lock threaded connections against pressure of gas, air, water, oils, hydrocarbons and many chemicals. They replace hemp and P.T.F.E. tapes and are available in various grades of locking strength with resistance to various chemicals. Certified according to various international standards, e.g. DVGW, NSF, WRAS, KTW, BAM

*****REMARK**

CLASS OF LOCKING

- 1 = LOW STRENGTH - EASY TO DISMANTLE
- 2 = MEDIUM STRENGTH - POSSIBLE TO DISMANTLE
- 3 = HIGH STRENGTH - PERMANENT LOCKING

F = Fluorescent: when exposed to UV light.

Thixotropy: capability of an adhesive to reduce its viscosity when exposed to stress.

BROOKFIELD VISCOSITY

- HT = HIGH THIXOTROPY
- MT = MEDIUM THIXOTROPY
- LT = LOW THIXOTROPY

LOCKING TORQUE

- BOLT M10 X 20 ZINC - QUALITY 8.8
- NUT = 0,8 d
- STANDARD ISO 10964

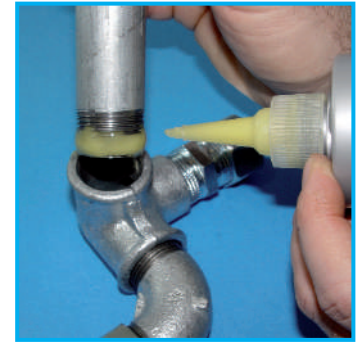

PRODUCT NUMBER	*** CLASS OF LOCKING	MAX DIAMETER OF THREAD MAX GAP FILLING		*** VISCOSITY 25°C mPa s (LT-MT-HT)		COLOR	CURING TIME		*** LOCKING TORQUE N.m (ISO 10964)		SHEAR STRENGTH (ISO 10123) N/mm ²	TEMPERATURE RANGE °C	DESCRIPTION SUGGESTED APPLICATIONS
							HANDLING MINUTES	FUNCTIONAL HOURS	BREAKAWAY	PREVAILING			
15-36	1	2"	0,30 mm	3000-6000	LT	BLUE/F	15 - 30	1 - 3	8 - 14	4 - 8	4 - 6	-55 +180	1. EASY TO DISMANTLE Threadsealant high temperature, approved for gas DVGW. Elastic film. High viscosity PTFE sealant for liquids and gas - approved for gas A.G.A./DVGW and potable water WRAS - Elastic film. Low strength sealant for small threads and pneumatic fittings.
18-10	1	2"	0,30 mm	17000-70000	HT	WHITE IVORY/F	20 - 40	1 - 3	6 - 11	2 - 5	4 - 6	-55 +150	
23-18	1	3/4"	0,15 mm	600-800	LT	BLUE/F	15 - 30	1 - 3	5 - 8	2 - 5	3 - 5	-55 +150	
53-14	2	3/4"	0,15 mm	400-650	LT	BROWN/F	10 - 20	1 - 3	12 - 18	10 - 20	8 - 12	-55 +150	2. MEDIUM STRENGTH-POSSIBLE TO DISMANTLE Hydraulic sealant. General purpose for pneumatic and hydraulic connectors up to 3/4". Approved for gas (DVGW). Sealant for fittings - General purpose. Sealant for steam, gas, liquids. Approved for gas (DVGW). Elastic film Sealant for large tolerance fittings. High viscosity PTFE sealant, fast curing - Approved for gas - Gaz de France. High viscosity sealant approved for gas (DVGW) GPL high pressure (AGA), oxygen (BAM) and potable water (WRAS). Certified NSF P1. Sealant paste "green", no Risk Phrases, blank MSDS.
55-14	2	2"	0,30 mm	2500-12000	MT	RED/F	10 - 20	1 - 3	12 - 18	20 - 30	8 - 12	-55 +150	
55-37	2	1 1/2"	0,25 mm	2500-4500	LT	RED/F	15 - 30	1 - 3	15 - 32	25 - 45	10 - 14	-55 +150	
56-03	2	2"	0,30 mm	5000-30000	MT	BLUE/F	15 - 30	1 - 3	10 - 16	12 - 20	8 - 12	-55 +150	
58-10	2	2"	0,30 mm	25000-90000	HT	WHITE/F	5 - 10	0,5 - 1	18 - 25	10 - 20	6 - 13	-55 +150	
58-11	2	2"	0,30 mm	20000-70000	HT	YELLOW/F	15 - 30	1 - 2	18 - 24	7 - 14	6 - 13	-55 +150	
58-12	2	2"	0,30 mm	20000-80000	HT	YELLOW	15 - 30	1 - 2	18 - 24	7 - 14	6 - 13	-55 +150	
82-01	3		0,15 mm	200-300	LT	GREEN	2 - 5	1 - 3	20 - 35	50 - 70	20 - 30	-55 +175	3. PER MONTAGGIO PERMANENTE Low viscosity, fast curing. High temperature, low viscosity - approved for gas DVGW, potable water WRAS. Maximum locking torque on yellow brass fittings. Sealant, locker for high temp. Keeps sealing properties up to +250°C. High resistance, fast curing, large tolerances. Approved for gas Gaz de France. For high temperatures, approved for gas and potable water (DVGW-TZW). Delayed curing sealant. Maximum locking torque on yellow brass fittings.
83-50	3	3/4"	0,20 mm	400-1000	LT	GREEN/F	5 - 10	1 - 3	25 - 35	40 - 50	25 - 35	-55 +200	
83-58	3		0,15 mm	500-700	LT	BLUE	15 - 30	1 - 3	25 - 35	45 - 55	15 - 25	-55 +150	
84-90	3	1 1/2"	0,20 mm	1000-1500	LT	GREEN	15 - 30	1 - 3	20 - 30	30 - 40	10 - 20	-55 +250	
85-21	3	1 1/2"	0,20 mm	2600-3100	LT	GREEN/F	2 - 5	1 - 3	30 - 40	50 - 70	25 - 35	-55 +150	
85-86	3	2"	0,30 mm	2200-4000	LT	GREEN/F	20 - 40	6 - 12	25 - 35	40 - 55	15 - 25	-55 +200	
86-55	3	2"	0,30 mm	5000-8000	LT	RED/F	60 - 90	12 - 24	20 - 35	30 - 45	10 - 20	-55 +150	
86-58	3	2"	0,30 mm	5000-7000	LT	RED/F	30 - 60	6 - 12	35 - 40	40 - 50	15 - 25	-55 +150	

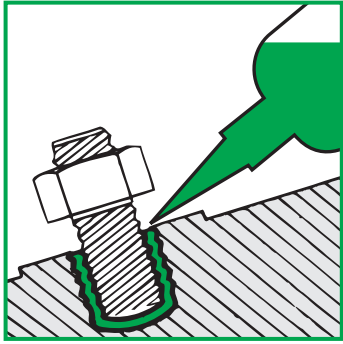

ThreadLocking

Anaerobic threadlockers lock studs, nuts, screws and any threaded fasteners. The adhesive prevents loosening caused by vibration, mechanical and thermal shock. Threadlocking adhesive also inhibits fretting corrosion and prevents the seizure and galling.

*****REMARK CLASS OF LOCKING**
 1 = LOW STRENGTH - EASY TO DISMANTLE
 2 = MEDIUM STRENGTH - POSSIBLE TO DISMANTLE
 3 = HIGH STRENGTH - PERMANENT LOCKING

BROOKFIELD VISCOSITY
 HT = HIGH THIXOTROPY
 MT = MEDIUM THIXOTROPY
 LT = LOW THIXOTROPY

LOCKING TORQUE
 BOLT M10 X 20 ZINC - QUALITY 8.8
 NUT = 0,8 d
 STANDARD ISO 10964

F = Fluorescent: when exposed to UV light.
Thixotropy: capability of an adhesive to reduce its viscosity when exposed to stress.



PRODUCT NUMBER	*** CLASS OF LOCKING	MAX DIAMETER OF THREAD MAX GAP FILLING		*** VISCOSITY 25°C mPa.s (LT-MT-HT)	COLOR	CURING TIME		*** LOCKING TORQUE N.m (ISO 10964)		SHEAR STRENGTH (ISO 10123) N/mm ²	TEMPERATURE RANGE °C	DESCRIPTION SUGGESTED APPLICATIONS	
						HANDLING MINUTES	FUNCTIONAL HOURS	BREAKAWAY	PREVAILING				
24-18	1	M24	0,20 mm	800-1400	MT	PURPLE/F	15 - 30	1 - 3	5 - 8	2 - 5	3 - 5	-55 +150	1. THREADLOCKING EASY TO DISMANTLE Low strength locking and anti-vibration. General purpose. Low strength locking for small screws.
32-18	1	M12	0,10 mm	120-170	LT	VIOLET/F	15 - 20	3 - 6	6 - 10	3 - 6	5 - 7	-55 +150	
52-03	2	M12	0,10 mm	120-170	LT	BLUE/F	10 - 20	1 - 3	10 - 14	14 - 24	8 - 12	-55 +150	2. THREADLOCKING MEDIUM STRENGTH Medium strength locking for small diameter screws and fasteners. Nut-lock general purpose. Medium locker "green", no Risk Phrases, blank MSDS. Medium strength locking suitable on oily surfaces. Approved for gas and potable water (DVGW-TZW). Temperature resistance up to +200°C. Locking of large diameter studs.
54-03	2	M24	0,20 mm	900-1500	MT	LIGHT BLUE/F	10 - 20	1 - 3	14 - 20	4 - 9	8 - 12	-55 +150	
55-02	2	M36	0,25 mm	2500-12000	MT	BLUE	20 - 40	6 - 12	18 - 25	9 - 16	9 - 13	-55 +150	
55-03	2	M36	0,25 mm	1700-9000	MT	BLUR/F	10 - 20	1 - 3	18 - 23	9 - 16	9 - 13	-55 +200	
55-04	2	M36	0,25 mm	1500-8600	MT	RED/F	10 - 15	1 - 3	20 - 25	40 - 50	10 - 15	-55 +150	
70-10		M5	0,07 mm	10-20	LT	GREEN/F	40- 80	3 - 6	5 - 15	2 - 10	5 - 10	-55 +150	3. THREADLOCKING HIGH STRENGTH Penetrating threadlocker. Suitable for sealing of copper pipes on aluminium plates. Penetrating. For use on assembled parts or to seal metal porosity. High strength locker "green", no Risk Phrases, blank MSDS. High strength. General purpose. Temperature resistance up to +200°C. High strength stud lock, even for oily surfaces. Retaining, sealing, threadlocking. Large tolerances threadlocking and sealing. High strength threadlocking and sealing, high temperature resistance up to +230°C. DVGW approved for gas.
70-14	3	M5	0,07 mm	10-20	LT	GREEN/F	10 - 20	1 - 3	10 - 25	25 - 40	8 - 12	-55 +150	
83-52		M20	0,15 mm	450-650	LT	GREEN/F	10 - 20	1 - 3	25 - 35	50 - 65	15 - 20	-55 +150	
83-54	3	M20	0,15 mm	450-650	LT	GREEN/F	10 - 20	1 - 3	25 - 35	50 - 65	15 - 20	-55 +150	
83-55	3	M20	0,15 mm	450-600	LT	RED/F	10 - 20	1 - 3	25 - 35	50 - 65	15 - 20	-55 +150	
85-56	3	M56 2" 0,30 mm		2500-4500	LT	BLUE/F	15 - 30	3 - 6	35 - 40	40 - 50	15 - 25	-55 +150	
86-54	3	M56 2" 0,30 mm		8000-24000	MT	GREEN/F	15 - 30	3 - 6	40 - 50	45 - 55	15 - 25	-55 +150	
86-72	3	M56 2" 0,30 mm		5000-28000	MT	RED	20 - 40	3 - 6	25 - 35	45 - 60	10 - 20	-55 +230	

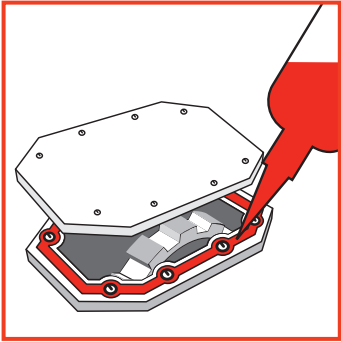

Liquid Gasketing

Gasketing anaerobic adhesive seals flat mating surfaces and joins flanges on pumps, gearboxes and differential housings. It replaces preformed gaskets and allows contact between metal parts forming a seal which is not prone to creep or relaxation. Forms a flexible and / or elastic gasket which is resistant to vibration, heat, oil and other industrial fluids. Parts can be disassembled using normal tools.

*****REMARK CLASS OF LOCKING**
 1 = LOW STRENGTH - EASY TO DISMANTLE
 2 = MEDIUM STRENGTH - POSSIBLE TO DISMANTLE
 3 = HIGH STRENGTH - PERMANENT LOCKING

BROOKFIELD VISCOSITY
 HT = HIGH THIXOTROPY
 MT = MEDIUM THIXOTROPY
 LT = LOW THIXOTROPY

LOCKING TORQUE
 BOLT M10 X 20 ZINC - QUALITY 8.8
 NUT = 0,8 d
 STANDARD ISO 10964

F = Fluorescent: when exposed to UV light.
Thixotropy: capability of an adhesive to reduce its viscosity when exposed to stress.

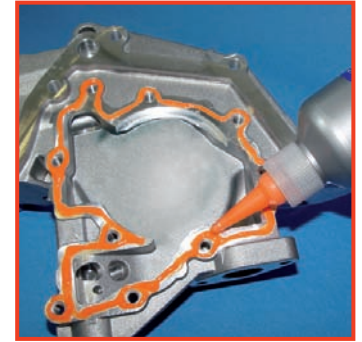

PRODUCT NUMBER	*** CLASS OF LOCKING	MAX GAP FILLING	*** VISCOSITY 25°C Pa.s	COLOR	CURING TIME		ADHESIVE STRENGTH			TEMPERATURE RANGE °C	DESCRIPTION SUGGESTED APPLICATIONS	
					HANDLING MINUTES	FUNCTIONAL HOURS	SHEAR (ASTM D 1002) N/mm ²	TENSILE (ASTM D 2095) N/mm ²	IMPACT (ASTM D 905) N/mm ²			
28-10	1	0,30 mm	17-60	HT	GREEN/F	20 - 40	3 - 6	4 - 6	2 - 4	2 - 4	-55 +150	Excellent resistance to vibration resistant for flexible flanges.
28-16	1	0,30 mm	50-300	HT	RED	15 - 30	3 - 6	2 - 4	1 - 3	2 - 4	55 +150	Flange sealant "green", easy dismantle, no Risk Phrases, blank MSDS.
58-14	2	0,50 mm	28-100	HT	ORANGE	15 - 30	3 - 6	5 - 10	5 - 8	3 - 5	-55 +150	General gasketing applications. General purpose.
58-31	2	0,50 mm	70-600	HT	RED/F	10 - 20	1 - 3	8 - 13	7 - 10	4 - 7	-55 +180	High temperature, elastic. Hot oil and fuel resistant, high dynamic loads, high performance applications.
59-10	2	0,50 mm	50-300	HT	RED/ ORANGE	15 - 30	3 - 6	5 - 10	6 - 8	3 - 5	-55 +200	High viscosity gasketing. Gearboxes for trucks and tractors.

Elastomeric & Plastic Gasket

PRODUCT NUMBER	*** VISCOSITY 25°C Pa.s	COLOR	CURING TIME		ELONGATION AT BREAK %	TENSILE STRENGTH N/mm ²	HARDNESS SHORE A	TEMPERATURE RANGE °C	DESCRIPTION SUGGESTED APPLICATIONS
			INITIAL STRENGTH minutes	CORD Ø 2 mm					
59-20	PASTOSO	TRASPARENT	15 - 30	24 h	400 - 600	0,8 - 2	15 - 25	-55 +180	Odourless silicone. Oil resistant.
		GREY	30 - 50	24 h	300 - 500	0,6 - 1,5	15 - 25	-55 +180	Odourless silicone. Oil resistant.
59-30	PASTOSO	RED/BLACK	10 - 20	24 h	400 - 600	1,5 - 2,5	25 - 35	-60 +250	Silicone for high temperature applications.
59-40	PASTOSO	TRASPARENT	10 - 20	24 h	100 - 200	1 - 2	35 - 45	-40 +90	MS polymer odourless, UV resistant, can be painted.
		GREY	10 - 20	24 h	200 - 300	1,5 - 2,5	55 - 65	-40 +90	Seals and bond different kind of materials.
59-42	15 - 70	GREY	10 - 20	12-24 h	100 - 200	0,5 - 1,5	40 - 50	-40 +100	Self leveling MS Polymer, to fill and to seal different substrates.
08-07	1000-6000 HT	BLUE/F	IMMEDIATE SEALING					-55 +120	Non curing solventless plastic sealant for threads and flange joints. Designed to cover preformed gaskets.

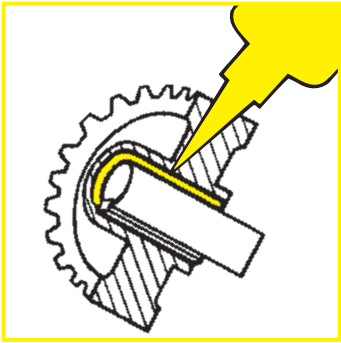

Retaining

Retaining anaerobic adhesives lock and fit bushes, bearings, sleeves, pin hubs, pulleys, gears and other cylindrical components. They are ideal for increasing the strength of press fit parts or retaining loose fitting parts, allow larger machining tolerances, reducing manufacturing costs, prevent fretting corrosion, vibration loosening and distortion. Retaining adhesives have excellent chemical resistance and seal against most fluids.

*****REMARK CLASS OF LOCKING**
 1 = LOW STRENGTH - EASY TO DISMANTLE
 2 = MEDIUM STRENGTH - POSSIBLE TO DISMANTLE
 3 = HIGH STRENGTH - PERMANENT LOCKING

BROOKFIELD VISCOSITY
 HT = HIGH THIXOTROPY
 MT = MEDIUM THIXOTROPY
 LT = LOW THIXOTROPY

LOCKING TORQUE
 BOLT M10 X 20 ZINC - QUALITY 8.8
 NUT = 0,8 d
 STANDARD ISO 10964

F = Fluorescent: when exposed to UV light.
Thixotropy: capability of an adhesive to reduce its viscosity when exposed to stress.



PRODUCT NUMBER	**** CLASS OF LOCKING	MAX DIAMETER OF THREAD MAX GAP FILLING		VISCOSITY 25°C mPa.s (LT-MT-HT)		COLOR	CURING TIME		LOCKING TORQUE (ISO 10964) N.m		SHEAR STRENGTH (ISO 10123) N/mm ²	TEMPERATURE RANGE °C	DESCRIPTION SUGGESTED APPLICATIONS
							HANDLING MINUTES	FUNCTIONAL HOURS	BREAKAWAY	PREVAILING			
53-11	2	M20	0,12 mm	400-650	LT	YELLOW/F	10 - 20	1 - 3	11 - 20	15 - 30	8 - 12	-55 +150	MEDIUM STRENGTH LOCKING, EASY TO DISMANTLE WITH STANDARD TOOLS Retaining of bearings. General purpose.
82-13	3	M12	0,10 mm	120-180	LT	GREEN/F	30 - 60	12 - 24	15 - 25	35 - 45	15 - 30	-55 +150	PERMANENT LOCKING Precision assembling, delayed curing.
82-21	3	M12	0,10 mm	120-180	LT	GREEN	5 - 10	1 - 3	24 - 35	50 - 60	17 - 22	-55 +150	Fast curing for precision assembling.
82-33	3	M12	0,10 mm	120-180	LT	GREEN	5 - 10	1 - 3	20 - 30	45 - 60	17 - 22	-55 +150	High strength retainer, recommended on oily surfaces.
83-03	3	M20 3/4"	0,20 mm	800-1200	LT	GREEN/F	1 - 5	1 - 3	25 - 35	55 - 70	25 - 35	-55 +200	Retainer and sealant. Very fast curing. High temperature performance for automatic assembling. Approved for gas - Gaz de France.
83-21	3	M20 3/4"	0,15 mm	400-600	LT	GREEN/F	2 - 5	1 - 3	25 - 35	55 - 70	25 - 35	-55 +175	Retainer and sealer fast curing. High temperature performance. Approved for oxygen - BAM.
85-02		M36 1 1/2"	0,20 mm	3000-4000	MT	GREEN/F	2 - 5	1 - 3	30 - 40	55 - 70	25 - 35	-55 +175	Fast curing retainer and sealant. High temperature resistant. Allows large connection tolerances.
85-21	3	M36 1 1/2"	0,20 mm	2600-3100	LT	GREEN/F	2 - 5	1 - 3	30 - 40	50 - 70	25 - 35	-55 +150	Fast curing retainer allows larger machining tolerances. Approved for gas - Gaz de France.
85-61 UV AE	3	M36 1 1/2"	0,20 mm	3000-4000	LT	BLUE/F	2 - 5	1 - 3	30 - 40	50 - 70	25 - 35	-55 +150	Anaerobic and UV high strength retainer for metal cylindrical assemblies. Curing is effected in seconds by UV light and in a few minutes between mating surfaces by anaerobic curing.
86-86	3	2"	0,30 mm	5000-35000	MT	GREEN/F	20 - 40	3 - 6	25 - 30	40 - 70	10 - 20	-55 +230	Retainer and Sealant. High mechanical strength at high temperatures. Approved for gas DVGW.
89-51	3	2"	0,30 mm	60000-720000	HT	SILVER	15 - 30	3 - 6	40 - 45	15 - 20	20 - 30	-55 +150	Paste retainer to repair damaged shafts and threads.



Activators & Surface Conditioners for Anaerobic Adhesives, Acrylic Adhesives, Cyanoacrylate Adhesives



The activators are specially designed products to speed up the cure of Anaerobic Adhesives. Typical conditions of use are low temperatures, large gaps, inactive or passive surfaces.

ATTIVATORE 11

Solvent based formulated accelerator, available in liquid and aerosol form. Fixture time about 1 minute.

ATTIVATORE 18

Liquid accelerator, solvent free, odourless. Fixture time about 1 minute.

ATTIVATORE 20

Liquid accelerator, solvent free, for contact curing adhesives and anaerobic. Fixture time 1- 2 minutes.

PULITORE 10

Fast drying cleaner and degreaser to optimally prepare the surfaces to be bonded. Suitable for metal, glass, ceramics, rubber and plastic. Available in aerosol form.

PRIMER 7

Liquid primer for difficult plastics, PE, PP, Elastomers, Silicone and PTFE. Speed up curing and avoid blooming effect.

ATTIVATORE 9

For instant curing of Cyanacrylate adhesives on porous or acidic surfaces. Eliminates the blooming effect. To be used as primer or for post curing excess adhesive. Available as liquid formulation or aerosol.

CR 1

CA remover solvent based. To remove and clean from hardened CA adhesive and to debond parts.

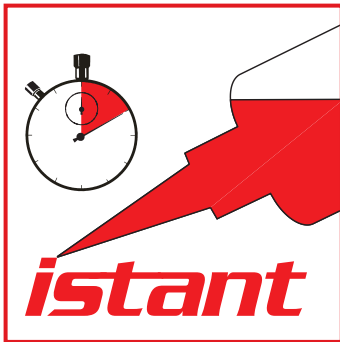

Instant Adhesives

Cyanacrylate adhesives are for the instant and structural bonding of rubber, metals, ceramic, leather and a variety of plastics. Best results can be obtained with joint gaps of less than 0.1mm up to 0.2mm for special grades. The service temperature range is between -50°C and +80°C, although new high-temperature resistant formulations are available for use up to 200°C. For porous surfaces or for vertical application a gel grade is available.



	GRADE	CHEMICAL COMPOSITION	SPECIFIC GRAVITY	VISCOSITY (25°C mPa.s)	GAP FILLING (microns)	SPEED OF CURE (*)	TENSILE STRENGTH (ASTM D 2095) N/mm ²	SHEAR STRENGTH N/mm ²	PROPERTIES
TIPI STANDARD	14	METHYL	1,15	80 - 150	10 - 100	2	25 - 30	20 - 25 (1)	For rigid materials, like rubber-metal. Slow setting. High strength.
	23	ETHYL	1,06	40 - 80	10 - 60	3	12 - 25	13 - 18 (2)	General purpose for rubbers and plastics. Medium setting.
	25	ETHYL	1,07	350 - 450	10 - 150	3	15 - 23	13 - 20 (1)	Fills large gaps, for rubbers, plastics, metals and ceramics.
	32	ETHYL	1,05	5 - 10	10 - 40	5	12 - 25	13 - 18 (2)	Very fast curing. Very good results on EPDM and foam rubbers, difficult rubbers and plastics.
	34	ETHYL	1,06	10 - 30	10 - 100	5	12 - 25	13 - 18 (2)	Very fast curing. Very good results on EPDM and foam rubbers, difficult rubbers and plastics.
	435	ETHYL	1,06	80 - 150	10 - 150	5	15 - 25	15 - 20 (1)	General purpose, faster setting on acidic surfaces, for leather, wood and metals. High temperature resistance up to +120°C.
TIPI COMPLEMENTARI	63	ALCOXI	1,07	80 - 150	10 - 150	1	10 - 25	12 - 22 (1)	General purpose, odour free, no blooming.
	17	METHYL	1,19	1200 - 1800	10 - 200	1	25 - 30	20 - 25 (1)	High viscosity, for rigid materials, fills large gaps, slow setting, high resistance.
	27	ETHYL	1,08	1400 - 2000	10 - 200	2	18 - 25	13 - 18 (1)	High viscosity, for rubbers, plastics, fills large gaps.
	29	ETILE/NERO	1,06	500 - 1500	10 - 200	1	18 - 25	13 - 18 (1)	General purpose, elastomeric, flexible.
	37	ETHYL	1,05	1000 - 2000	10 - 200	3	12 - 25	16 - 20 (1)	Flexible, mid/high viscosity, high impact strength, for rubber, plastic, metals and ceramics
	41	ETHYL	1,05	5 - 10	10 - 40	5	18 - 25	13 - 18 (1)	Low viscosity, fast setting on acidic surfaces.
	45	ETHYL	1,06	600 - 1200	10 - 200	4	12 - 25	12 - 20 (1)	Medium viscosity, general purpose, fast setting on acidic surfaces.
	47	ETHYL	1,08	GEL	10 - 300	2	18 - 25	13 - 18 (1)	Gel, fills large gaps, for vertical bonding and porous surfaces. High temperature resistance up to +120°C.
	48	ETHYL	1,05	FLUID GEL TIXO	10 - 300	2	18 - 25	13 - 18 (1)	Fluid gel, to bond porous and vertical surfaces, recommended for assembly lines.
	51	ETHYL	1,06	80 - 110	10 - 100	2	18 - 25	18 - 25 (1)	General purpose, for assemblies subjected to temperature +160°C.
	52	ETHYL	1,06	80 - 110	10 - 100	2	18 - 25	18 - 25 (1)	General purpose, for assemblies subjected to temperature +160°C.
	55	ETHYL	1,06	600 - 1000	10 - 200	2	18 - 25	13 - 18 (1)	General purpose, for assemblies subjected to temperature +160°C.
	67	ALCOXI	1,1	1000 - 1500	10 - 200	1	10 - 25	12 - 22 (1)	High viscosity, fills large gaps, odour free, no blooming.
	73	ETHYL	1,06	100 - 200	10 - 150	2	12 - 25	15 - 25 (1)	General purpose, flexible, transparent, high temperature resistance up to 100°C.
74	ETHYL/BLACK	1,06	100 - 200	10 - 150	2	12 - 25	15 - 25 (1)	General purpose, flexible, high temperature resistance up to 100°C.	
75	ETHYL	1,10	4000 - 5000	10 - 200	2	12 - 25	15 - 25 (1)	Tough, viscous, high peel and impact resistant, general purpose	
77	ETHYL/BLACK	1,10	2000 - 4000	10 - 200	2	12 - 25	15 - 25 (1)	Tough, flexible, viscous, high peel and impact resistant, high temp. resistant up to +120°C.	

(1) ISO 4587 Norm

(2) ISO 10123 Norm

(*) Relative setting time (5= max, 1 = min.)

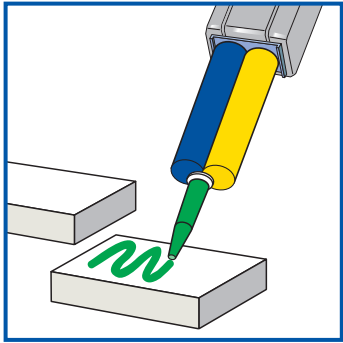

Two Part Epoxy Adhesives

Dual cartridges with static mixer.

Two-part engineering adhesives provide high strength, structural joints. They are suitable for bonding metals, ceramics, wood and some plastics and they are supplied in a practical dual cartridge dispenser. Curing occurs upon mixing of the two components (resin and hardener). Fixture time is from 5 - 10 minutes to several hours. Applying heat will accelerate the cure speed. Temperature resistance is between -30°C and +80°C.



PRODUCT NUMBER	CHARACTERISTICS	COLOR	VISCOSITY (25°C Pa s)	HANDLING TIME (25°C)	FUNCTIONAL HOURS (+25°C)	SHEAR STRENGTH (ISO 4587) N/mm ²	PEEL STRENGTH (ISO 4578) N/25 mm	DESCRIPTION
31-10	TOUGH	AMBER	12-18 (1) / 10-25 (2)	90' - 150' (*)	12 - 24 h	12 - 14	10 - 25	Slow curing, tough.
31-40	FAST CURING	COLORLESS	12-18 (1) / 15-30 (2)	10' - 20" (*)	30' - 40'	10 - 12	4 - 20	Fast curing, colorless, non yellowing.
31-42	VERY FAST CURING	COLORLESS	12-18 (1) / 15-30 (2)	3' - 8" (*)	20' - 30'	12 - 14	4 - 20	Very fast curing, colorless, non yellowing.
34-15	VERY FLEXIBLE	AVORY	20-35 (1) / 20-50 (2)	15' - 35" (*)	12 - 24 h	5 - 10	40 - 70	Longer setting time, very flexible, high peel and shock resistant.
35-44	TOUGH/FLEXIBLE	COLORLESS	10-20 (1) / 14-24 (2)	10' - 20" (*)	40' - 60'	5 - 9	25 - 60	Fast setting, very good peel resistance, excellent adhesion to metals.
36-10	TOUGH/FLEXIBLE	AVORY	14-28 (1) / 10-25 (2)	90' - 150" (*)	12 - 24 h	12 - 18	25 - 40	Slow curing, tough, flexible.
3614	TOUGH/FAST CURING	GREY	45-170 (1) / 40-170 (2)	30' - 40" (*)	3 - 4 h	15 - 25	40 - 70	Tough, viscous, curing 24h.
4401	TOUGH/HIGH-TEMPERATURE	GREY	80-160 (1) / 180-400 (2)	10' - 12'	24 - 36 h	20 - 30	150 - 300 (**)	Mixing ratio 2:1. Tough, semi-flexible, temperature resistant up to +120°C, peaks at 140°C.
4821	TOUGH/FLEXIBLE	GREY/ BLACK	PASTY TIXO	10' - 13'	72 h	4 - 7	60 - 80	Mixing ratio 2:1. Flexible and tough. Bonds plastics, metals, ceramics and composites. Fill large gaps, resistant up to 120°C.
EPOSTICK	PASTY TIXO COMPOUND	AMBER	PASTY	5' - 7'	15' - 25'	4 - 6	-	Epoxy putty for repair. To seal and to fill cracks.

Viscosity = (1) Resin - (2) Hardener

(*) Time measured on 2 gr. Part A and 1 gr. Part B mixed product

(**) With hot curing for 60 'to +80°C

1K structural epoxy heat curing

Excellent adhesion on metals, ceramics and many composites substrates. It can replace mechanical fastening and soldering. Heat curing between +120°C and +200°C.

PRODUCT NUMBER	CHARACTERISTICS	COLOR	VISCOSITY (25°C Pa s)	HANDLING TIME A +150°C	SHEAR STRENGTH (ISO 4587) N/mm ²	PEEL STRENGTH (ISO 4578) N/25 mm	TEMPERATURE RANGE °C	DESCRIZIONE
4500	TOUGH	GREY	800 - 3800 tixo	30' - 45' (*)	20 - 30	80 - 120	-40 +180	High viscosity, non dripping, high tensile, peeling and shear strength. Fills large gaps.
4580	TOUGH	GREY	150 - 250	45' - 60" (*)	18 - 25	80 - 120	-40 +180	Mid viscosity, self leveling, fluidifies during hardening.
4620	TOUGH/FLUID	WHITE	10 - 20	30' - 45' (*)	18 - 25	-	-40 +180	Low viscosity, self leveling.
4680	TOUGH/RAPID	AVORY	60 - 100	15' - 30" (*)	20 - 25	-	-40 +180	Mid/high viscosity, high impact strength, for bonding ferrite and magnets.
4690	TOUGH	BLACK	200 - 1800 tixo	45' - 60" (*)	18 - 25	80 - 150	-40 +180	Mid/high viscosity, high tensile, peeling and shear strength. Non dripping.
4700	TOUGH/FLUID	AMBER	2 - 6	60'-90' (a +90°C)	15 - 25	-	-40 +180	Fluid, self leveling, general purpose. Hardening at +90°C.
4730	TOUGH/RAPID	AVORY	10 - 20	20'-30' (a +115°C)	-	-	-40 +180	For needle bonding.
4780	THERMOCONDUCTIVE	BLACK	400 - 1500 tixo	30' - 45" (*)	15 - 25	-	-40 +180	Thermal conductive, mid/high viscosity. Fast heat conduction.

(*) | Curing time belongs to temperature.



Light Curing Adhesives

UV light curable adhesives polymerise in seconds by irradiation with UV and visible light, forming a solid adhesive film not yellowing over time. Designed to bond glass, crystal, metals and some plastics.

Operating temperature range between -50°C and +120°C.

A gel formulation is available for non-drip / vertical applications.



PRODUCT NUMBER	VISCOSITY (+25°C mPa s)	GAP FILLING mm	CURING TIME (in seconds)	TENSILE STRENGTH (ASTM D 2095-69) N/mm ²	DESCRIPTION
30-11	200 - 300	0,03 - 0,20	6 - 55	-	Low viscosity, for bonding plastics like PC, ABS, PVS. Designed for joining medical components. ISO 10993 certified for use with medical devices.
30-12	200 - 400	0,03 - 0,20	6 - 30	-	Fluid, for plastic bonding, fast and strong on PC and PMMA.
30-20	2200 - 2900	0,03 - 1,5	6 - 10	10 - 14	Medium viscosity, fast curing, designed for crystal figures, decorative objects.
30-21	600 - 1300	0,03 - 1,5	8 - 15	10 - 14	Low viscosity, for glass furniture, tough, for bonding on edges, plain glass and metals.
30-22	5500 - 7500	0,03 - 2	6 - 10	8 - 12	Viscoso. Colma giochi ampi, da usare quando le superfici non sono perfettamente complanari, per articoli decorativi.
30-23	50 - 100	0,03 - 1,5	8 - 15	10 - 14	Low viscosity, for glass furniture, for bonding on plain surfaces, simplifies cleaning of joined parts from excess adhesive after UV exposure.
30-24	2200 - 2900	0,03 - 1,5	6 - 10	12 - 16	Medium viscosity for glass on metal bonding, tough.
30-27	90 - 150	0,03 - 0,20	6 - 10	-	Low viscosity, suitable for application on medical devices like syringes and needles. Able to bond thermoplastics with glass and metals. ISO 10993 certified for use with medical devices.
30-30	500 - 800	0,03 - 1,5	5 - 10	8 - 14	Fluid, for float glass and precious crystals. Cleaning of excess of adhesive allowed after UV irradiation.
30-33	1000 - 2000	0,03 - 1,5	5 - 15	6 - 10	Fluid, high transparency in thickness, improved humidity resistance, glass/glass and glass/metals.
30-34	2500 - 3500	0,03 - 1,5	6 - 10	8 - 14	Mid viscosity, fast, high transparency in thickness, improved humidity resistance, recommended for small crystal objects and glasswares.
30-35	5000 - 8000	0,03 - 1,5	5 - 10	8 - 12	Mid/high viscosity, high transparency, for glass/glass and glass metals in wet environments.
30-36	5000 - 8000	0,03 - 1,5	5 - 10	8 - 12	Mid/high viscosity, high transparency in thickness, improved humidity resistance, glass/glass and glass/metals.
30-37	2200 - 2900	0,03 - 1,5	6 - 10	6 - 10	Flexible, shock resistant, ideal for bonding glass on plastic parts.
30-38	20000 - 30000	0,03 - 2	5 - 10	5 - 10	High viscosity, transparent in thickness, fill large gaps, glass/glass and glass/metals.
30-60	GEL	0,03 - 2,5	8 - 15	4 - 8	Non-drip gel, for vertical bonding of glass and crystal.
30-83	1000 - 1600	0,03 - 1	3 - 10	-	For potting and coating of chips. Dry film.

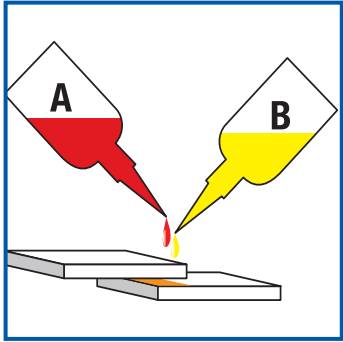

Structural Acrylic Adhesives

2-Component adhesives cure by contact (drop on drop, bead on bead). Curing time from 1 to 5 minutes. Suitable for bonding metals, ferrite, ceramics, wood and some plastics forming high strength durable joints with high impact, peel and tensile strength.

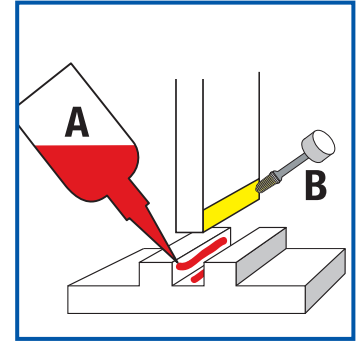

PRODUCT NUMBER	VISCOSITY (+25°C mPa s)	HANDLING TIME (minutes)	FUNCTIONAL TIME (minutes)	SHEAR STRENGTH (ASTM D 1002) N/mm ²	PEEL STRENGTH (ISO 4578) N/mm	JOINT THICKNESS mm	PROPERTIES
30-55 (+Att. 20)	7000 - 120000	1 - 4	30 - 60	12 - 25	3 - 5	0,05 - 1	Highly thixotropic, high peel and shock resistant contact curing acrylic adhesive.
33-00 (+Att. 20)	10000 - 80000	1 - 4	30 - 60	13 - 30	2 - 3	0,05 - 1	General purpose, contact curing acrylic adhesive.
33-47 (A+B)	5000 - 12000	1 - 3	30 - 60	12- 25	3 - 5	0,05 - 0,5	For bonding metals, ceramics and plastics.
33-47M (+Att. 17)	20000 - 70000	1 - 3	30 - 60	12- 25	3 - 5	0,05 - 0,5	For bonding of some plastics, e.g. ABS, polystyrene, polycarbonate on metal, and metal on metal.
3439 (+Att. 20)	600 - 1000	1 - 2	10 - 20	20 - 30	3 - 5	0,05 - 0,2	Fluid, high shear, peeling and impact strength, recommended for magnets, ferrite, metals and ceramics. High temperature resistance up to +165°C.
3459 (+Att. 20)	15000 - 100000 (gel)	1 - 2	10 - 20	20 - 30	3 - 5	0,05 - 0,5	Viscous (gel), high shear, peeling and impact strength, recommended for magnets, ferrite, metals and ceramics. High temperature resistance up to +165°C.
3592 (A+B)	10000 - 20000 (A) 3500 - 5500 (B)	< 1	10 - 20	20 - 25	-	0,05 - 0,5	Structural bonder curing by contact, drop on drop or bid on bid. Does not require mixing. Setting time 10-30". Recommend for bonding of magnets and ferrite on high speed assembly lines.



Impregnation of Porous Metal Parts



Low viscosity methacrylate resins for sealing metal micro porosity by vacuum impregnation of castings and sintered metal parts for automotive, pneumatic and hydraulic components. LOXEAL impregnation products meet the standards MIL-STD276, MIL-I-17563B and most automotive companies specifications.

PRODUCT CODE	CHEMICAL COMPOSITION	COLOR	VISCOSITY (25°C mPa.s)	SPECIFIC GRAVITY (25°C gr/ml)	FLUORESCENT EFFECT	TEMPERATURE RANGE (°C)	METHOD OF CURING
70-11	METHACRYLATE	AMBER TRANSPARENT	10 - 20	1,0	YES	-55 +150°C	≈ 2h/20°C (room temperature)
70-90	METHACRYLATE	AMBER TRANSPARENT	10 - 20	1,0	YES	-55 +150°C	5-15 min. (75°/90°C) (hot water)
70-91	METHACRYLATE	AMBER TRANSPARENT	10 - 20	0,9	YES	-55 +150°C	5-15 min. (75°/90°C) (hot water)

*Impregnation products are designed to be room temperature curing.
Impregnation cycle is performed in dedicated plants, according to the following scheme:*

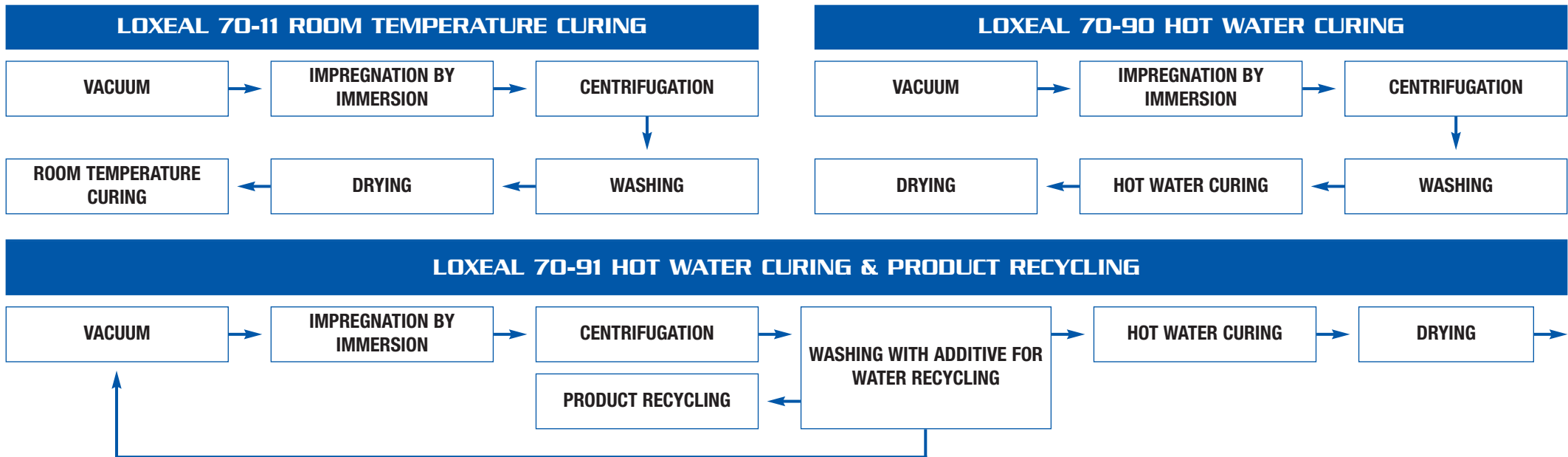

Dosing System

Loxreal® Dosing Systems are designed to fulfil customer's dispensing needs.

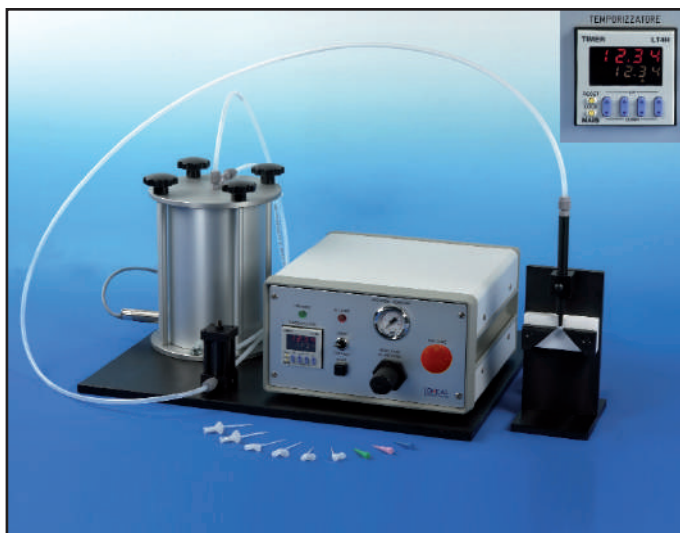

DE1 Electro Pneumatic Dosing Unit

Electro Pneumatic Dosing Unit (time-pressure) for Anaerobic and Cyanoacrylate Adhesives. Including Control unit, Reservoir (with empty level sensor), Valve, Dosing nozzle, actuated by Foot Switch or metal part Sensor. Suitable for PLC connections, equipped with end cycle alarm Sensor. Tubing is made by PE and PTFE flexible hoses.

Technical specification:

Dimension:	L490 x P390 x H250
Weight:	8 Kg.
Power supply:	230 V - 50 Hz
Max power:	75 W
Pressure rate:	from 4 to 8 bar
Dosing pressure adjustment:	from 0,1 to 5 bar
Reservoir capacity:	2,3 Liters
Dosing quantity:	0,03 ml to continuous trace
Dosing time:	0,05" to continuous



DE3 - DE3M Pneumatic Dosing Unit

Pneumatic Dosing Unit for manual dispensing of Anaerobic and Cyanoacrylate Adhesives. Equipped with foot switch or hand actuated dispensing valve. Does not require electrical power supply and is suitable for use in spark proof / flame proof environments.

Technical specification:

Dimension:	L490 x P390 x H390
Weight:	3,5 Kg.
Pressure rate:	from 4 to 8 bar
Dosing pressure adjustment:	from 0,1 to 5 bar
Reservoir capacity:	2,3 Liters
Dosing quantity:	Manual



DE4E Syringe Dosing Unit

Precise control time/pressure. Syringe terminal used as reservoir. Micro drops dispensing. Venturi technology to avoid dripping from syringe. Multipurpose dosing unit for different liquid products.

Technical specification:

Dimension:	L152 x P165 x H178
Weight:	Kg. 1,2
Power supply:	24 VCC
Max power:	10 W
Dosing pressure adjustment:	from 0,1 to 6 bar
Syringes capacity:	10 - 30 cc
Dosing quantity:	0,001 ml to continuous trace
Dosing time:	0,02" to continuous

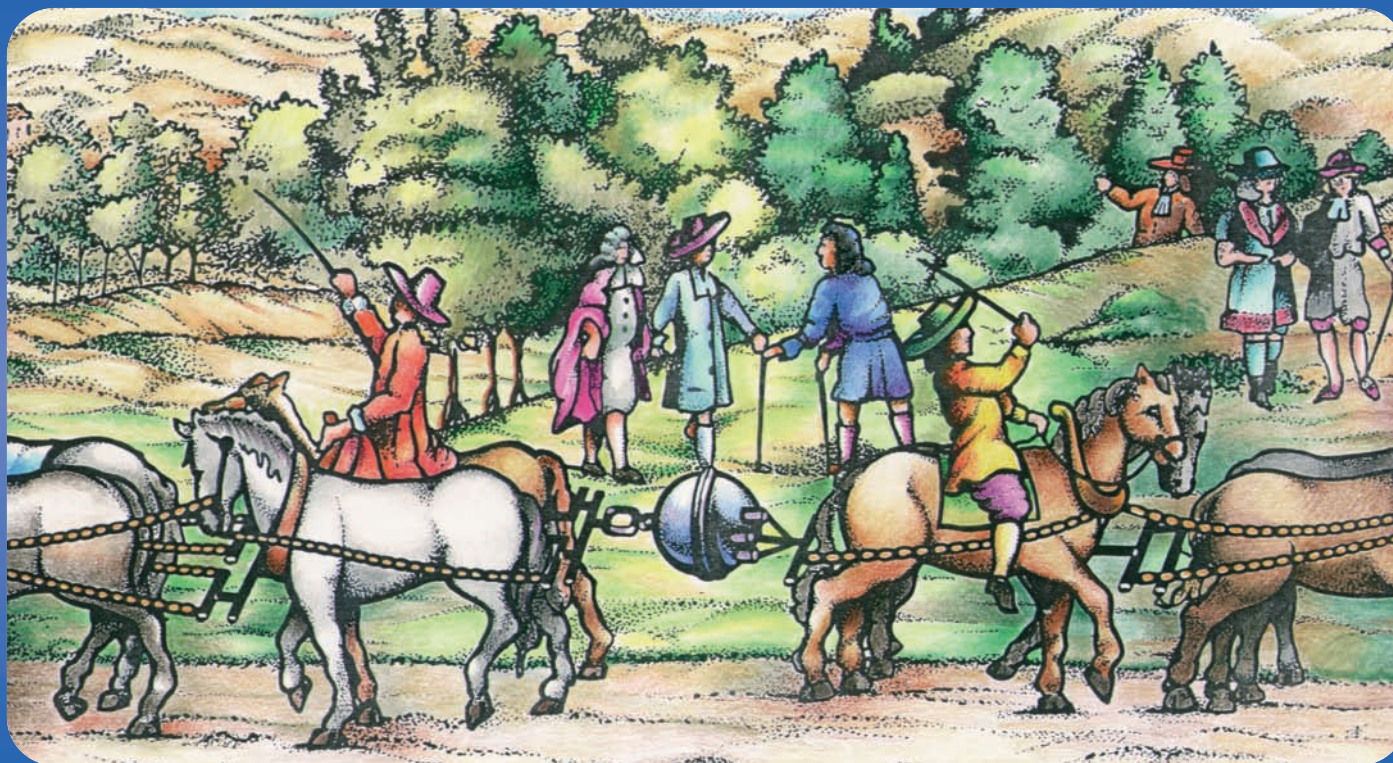

LOXEAL[®]
ENGINEERING ADHESIVES

Loxeal srl

Via Marconato, 2 - 20811 Cesano Maderno (MB) - Italia

Tel. +39.0362.551701 - Fax +39.0362.524225

www.loxeal.com