



# CATÁLOGO GENERAL

GENERAL CATALOGUE  
CATALOGUE GÉNÉRAL

## V.7

*Future needs tools*



**Certificación**  
Concedida a

**INDUSTRIAS TAYG SLU**

AVENIDA REAL DE MADRID NORTE, 70 - 46469 - BENIPARRELL - VALENCIA - ESPAÑA

Bureau Veritas Certification certifica que el Sistema de Gestión ha sido auditado y encontrado conforme con los requisitos de la norma:

NORMA:

**ISO 9001:2015**

El Sistema de Gestión se aplica a:

DISEÑO Y FABRICACIÓN DE ARTÍCULOS DE PLÁSTICO PARA BRICOLAJE, FERRETERÍA Y ALIMENTACIÓN. COMERCIALIZACIÓN DE ARTÍCULOS PARA BRICOLAJE, FERRETERÍA Y ALIMENTACIÓN.

Número del certificado: ES121878-1  
Aprobación original: 10-07-2009  
Certificado en vigor: 09-07-2021  
Caducidad del certificado: 08-07-2024

Este certificado está sujeto a las cláusulas y condiciones generales y particulares de los servicios de certificación.

Bureau Veritas Certification  
ENAC  
12, Valparaiso Primera 23-24, Edificio Corbu, 46100 Albaladejos - Madrid, España  
01.8555.6200

**Certification**  
Awarded to

**INDUSTRIAS TAYG SLU**

AVENIDA REAL DE MADRID NORTE, 70 - 46469 - BENIPARRELL - VALENCIA - ESPAÑA

Bureau Veritas Certification certifies that the Management System has been audited and found to be in accordance with the requirements of standard:

STANDARD:

**ISO 9001:2015**

Scope of certification:

DESIGN AND PRODUCTION OF PLASTIC ARTICLES FOR HARDWARE, D.I.Y. AND FOOD. COMMERCIALIZATION OF PRODUCTS FOR HARDWARE, D.I.Y. AND FOOD.

Certificate Number: ES121878-1  
Original approval date: 10-07-2009  
Effective date: 09-07-2021  
Certificate expiration date: 08-07-2024

This certificate is valid subject to the general and specific terms and conditions of certification services.

Bureau Veritas Certification  
ENAC  
12, Valparaiso Primera 23-24, Edificio Corbu, 46100 Albaladejos - Madrid, España  
01.8555.6200

**Certificación**  
Concedida a

**INDUSTRIAS TAYG SLU**

AVENIDA REAL DE MADRID NORTE, 70 - 46469 - BENIPARRELL - VALENCIA - ESPAÑA

Bureau Veritas Certification certifica que el Sistema de Gestión ha sido auditado y encontrado conforme con los requisitos de la norma:

NORMA:

**ISO 14001:2015**

El Sistema de Gestión se aplica a:

DISEÑO Y FABRICACIÓN DE ARTÍCULOS DE PLÁSTICO PARA BRICOLAJE, FERRETERÍA Y ALIMENTACIÓN. COMERCIALIZACIÓN DE ARTÍCULOS PARA BRICOLAJE, FERRETERÍA Y ALIMENTACIÓN.

Número del certificado: ES121877-1  
Aprobación original: 09-07-2018  
Certificado en vigor: 09-07-2021  
Caducidad del certificado: 08-07-2024

Este certificado está sujeto a las cláusulas y condiciones generales y particulares de los servicios de certificación.

Bureau Veritas Certification  
ENAC  
12, Valparaiso Primera 23-24, Edificio Corbu, 46100 Albaladejos - Madrid, España  
01.8555.6200

**Certification**  
Awarded to

**INDUSTRIAS TAYG SLU**

AVENIDA REAL DE MADRID NORTE, 70 - 46469 - BENIPARRELL - VALENCIA - ESPAÑA

Bureau Veritas Certification certifies that the Management System has been audited and found to be in accordance with the requirements of standard:

STANDARD:

**ISO 14001:2015**

Scope of certification:

DESIGN AND PRODUCTION OF PLASTIC ARTICLES FOR HARDWARE, D.I.Y. AND FOOD. COMMERCIALIZATION OF PRODUCTS FOR HARDWARE, D.I.Y. AND FOOD.

Certificate Number: ES121877-1  
Original approval date: 09-07-2018  
Effective date: 09-07-2021  
Certificate expiration date: 08-07-2024

This certificate is valid subject to the general and specific terms and conditions of certification services.

Bureau Veritas Certification  
ENAC  
12, Valparaiso Primera 23-24, Edificio Corbu, 46100 Albaladejos - Madrid, España  
01.8555.6200

**Certification**  
Attribuée à

**INDUSTRIAS TAYG SLU**

AVENIDA REAL DE MADRID NORTE, 70 - 46469 - BENIPARRELL - VALENCIA - ESPAÑA

Bureau Veritas certifie que le système de management a été évalué et jugé conforme aux exigences de la norme:

NORME:

**ISO 9001:2015**

Domaine d'activité du Système de Management:

PRODUCTION ET DESIGN D'ARTICLES EN PLASTIQUE POUR L'INDUSTRIE, LE BRICOLAGE ET L'ALIMENTAIRE. COMMERCIALISATION D'ARTICLES POUR L'INDUSTRIE, LE BRICOLAGE ET L'ALIMENTAIRE.

Numéro du certificat: ES121878-1  
Approbation originale: 10-07-2009  
Certificat en vigueur: 09-07-2021  
Validité du certificat: 08-07-2024

Ce certificat est soumis aux clauses et aux conditions générales et particulières des services de certification.

Bureau Veritas Certification  
ENAC  
12, Valparaiso Primera 23-24, Edificio Corbu, 46100 Albaladejos - Madrid, España  
01.8555.6200

**Zertifikat**  
Für

**INDUSTRIAS TAYG SLU**

AVENIDA REAL DE MADRID NORTE, 70 - 46469 - BENIPARRELL - VALENCIA - ESPAÑA

Bureau Veritas Certification bestätigt, dass das Management-System der oben genannten Organisation beurteilt wurde und die in den folgenden Normen und Regelwerken festgelegten Anforderungen erfüllt:

NORMEN:

**ISO 9001:2015**

Anwendungsbereich:

DESIGN UND HERSTELLUNG VON KUNSTSTOFFARTIKELN FÜR EISENWAREN, HEIMWERKEN UND LEBENSMITTEL. VERMARKTUNG VON ARTIKELN FÜR EISENWAREN, HEIMWERKEN UND LEBENSMITTEL.

Zertifikat Nummer: ES121878-1  
Datum der Erstzertifizierung: 10-07-2009  
Gültig ab: 09-07-2021  
Ablaufdatum des Zertifikats: 08-07-2024

Dieses Zertifikat ist gültig vorbehaltlich der allgemeinen und spezifischer Bedingungen von Zertifizierungsdiensten.

Bureau Veritas Certification  
ENAC  
12, Valparaiso Primera 23-24, Edificio Corbu, 46100 Albaladejos - Madrid, España  
01.8555.6200

**Certification**  
Attribuée à

**INDUSTRIAS TAYG SLU**

AVENIDA REAL DE MADRID NORTE, 70 - 46469 - BENIPARRELL - VALENCIA - ESPAÑA

Bureau Veritas certifie que le système de management a été évalué et jugé conforme aux exigences de la norme:

NORME:

**ISO 14001:2015**

Domaine d'activité du Système de Management:

PRODUCTION ET DESIGN D'ARTICLES EN PLASTIQUE POUR L'INDUSTRIE, LE BRICOLAGE ET L'ALIMENTAIRE. COMMERCIALISATION D'ARTICLES POUR L'INDUSTRIE, LE BRICOLAGE ET L'ALIMENTAIRE.

Numéro du certificat: ES121877-1  
Approbation originale: 09-07-2018  
Certificat en vigueur: 09-07-2021  
Validité du certificat: 08-07-2024

Ce certificat est soumis aux clauses et aux conditions générales et particulières des services de certification.

Bureau Veritas Certification  
ENAC  
12, Valparaiso Primera 23-24, Edificio Corbu, 46100 Albaladejos - Madrid, España  
01.8555.6200

**Zertifikat**  
Für

**INDUSTRIAS TAYG SLU**

AVENIDA REAL DE MADRID NORTE, 70 - 46469 - BENIPARRELL - VALENCIA - ESPAÑA

Bureau Veritas Certification bestätigt, dass das Management-System der oben genannten Organisation beurteilt wurde und die in den folgenden Normen und Regelwerken festgelegten Anforderungen erfüllt:

NORMEN:

**ISO 14001:2015**

Anwendungsbereich:

DESIGN UND HERSTELLUNG VON KUNSTSTOFFARTIKELN FÜR EISENWAREN, HEIMWERKEN UND LEBENSMITTEL. VERMARKTUNG VON ARTIKELN FÜR EISENWAREN, HEIMWERKEN UND LEBENSMITTEL.

Zertifikat Nummer: ES121877-1  
Datum der Erstzertifizierung: 09-07-2018  
Gültig ab: 09-07-2021  
Ablaufdatum des Zertifikats: 08-07-2024

Dieses Zertifikat ist gültig vorbehaltlich der allgemeinen und spezifischer Bedingungen von Zertifizierungsdiensten.

Bureau Veritas Certification  
ENAC  
12, Valparaiso Primera 23-24, Edificio Corbu, 46100 Albaladejos - Madrid, España  
01.8555.6200

# SOBRE NOSOTROS

About us / A propos de nous / Wir über uns



*Future needs tools*

Desde hace más de 50 años, apostamos por la calidad con el producto, el servicio y el medio ambiente. Donde el diseño y la innovación han sido piezas clave de nuestro continuo crecimiento, sin olvidar la importancia de la relación entre la máxima calidad y el mejor servicio. Nuestra compañía tiene dimensión y gran potencial operativo, con una capacidad de transformación de más de 7.000 Tn al año. Impulsados hacia una visión global cada vez mayor, una red de agentes se distribuyen por todo el mundo, estando presentes en más de 40 países de todo el mundo.

Siempre orientados al producto para el profesional, el DIY y relacionado con la construcción, el trabajo profesional y el mundo del bricolaje.

We have been working for over 50 years to bring innovation into our product range. Where Design and innovation have always been key elements of our continual growth, while preserving the best quality and service.

Our company has capacity and great operative potential, with a transformation capacity of more than 7,000 tonnes per year.

Driven towards a growing international vision, a network of agents are distributed throughout the world, being present in more than 40 countries.

Always focused to the product for the professional, the DIY and related with construction, professional work and the world of DIY.

Depuis plus de 50 ans, on a parié pour la qualité du produit, le service et l'environement. Ou le design et l'innovation ont été des pièces clé de croissance continue, sans oublier l'importance de la relation entre la qualité maximale et le meilleur service.

Notre société est bien structurée et a un grand potentiel opératif, avec une capacité de transformation de plus de 7000 tones de polymère a l'année. Impulsée vers une vision globale toujours majeure, un réseau d'agents distribué dans le monde entier, étant présents dans plus de 40 pays.

Toujours orientés aux produits pour professionnels, la grande distribution de bricolage et en relation avec la construction.

Seit mehr als 50 Jahren setzen wir auf Innovation unserer Erzeugnisse. Design und Innovation waren immer entscheidend für unser kontinuierliches Wachstum unter Einhaltung bester Qualität und Serviceleistungen. Unser Unternehmen besitzt hohe Kapazitäten und ein starkes, operatives Potential und eine Verarbeitungskapazität von mehr als 7.000 Tonnen im Jahr.

Im Sinne einer immer größeren, internationalen Vision besitzen wir weltweit ein Netzwerk von Vertretern und sind so in mehr als 40 Ländern präsent.

Immer auf das Produkt für den Profi, den Heimwerker und verwandte ausgerichtet mit Bau, professioneller Arbeit und der Welt des DIY.

# GUÍA

Guide / Guide / Leitfaden



## MATERIALES

Materials / Matériaux / Materialien



Polipropileno / Polypropylene / Polypropylène / Polypropylen  
Termoplástico tipo commodity (standard). Polímeros cristalizados aleatoriamente. Transparente.  
A commodity (standard) thermoplastic. Randomly crystallised polymers. Transparent.  
Produit de type thermoplastique (standard). Les polymères ont cristallisé au hasard. Transparent.  
Thermoplast für Bedarfsartikel (Standard). Zufällig kristallisierte Polymere. Durchsichtig.



Poliestireno / Polystyrene / Poliestirène / Polystyrol  
Termoplástico tipo commodity (standard). Polimerización del estireno.  
A commodity (standard) thermoplastic. Polymerisation of styrene.  
Produit de matériau thermoplastique (standard). Polymérisation du styrène.  
Thermoplast für Bedarfsartikel (Standard). Polymerisierung des Styrols.



Policarbonato / Polycarbonate / Polycarbonate / Polycarbonat  
Termoplástico de altas prestaciones (no es commodity). Alto impacto. Transparente.  
High-pressure thermoplastic (non-commodity). High-impact. Transparent.  
Thermoplastique de hautes prestations ( n'est pas commodity). Haut impacte. Transparent.  
Hoch leistungsfähiges Thermoplast (nicht für Bedarfsartikel). Sehr schlagzähe. Durchsichtig.



Polipropileno / Polypropylene / Polypropylène / Polypropylen  
Termoplástico tipo commodity (standard). Copolímeros opacos (polimerización de propileno con etileno o con butadieno).  
A commodity (standard) thermoplastic. Opaque copolymers (polymerization of propylene with ethylene or butadiene).  
Produit de type thermoplastique (standard). Polymères opaques (polymerisation du propylène et de l'éthylène ou avec du butadiène).  
Thermoplast für Bedarfsartikel (Standard). Matte Mischpolymere (Polymerisierung von Propylen mit Ethylen oder Butadien).



Poliétileno / Polyethylene / Polyéthylène / Polyethylen  
Termoplástico tipo commodity (standard). Polimerización del etileno. Alta densidad, buena resistencia a los ataques químicos.  
A commodity (standard) thermoplastic. Polymerisation of ethylene. High-density, good resistance to chemical attacks.  
Produit de type thermoplastique (standard). Polymérisation de l'éthylène. Haute densité, bonne résistance aux attaques chimiques.  
Thermoplast für Bedarfsartikel (Standard). Polymerisierung des Ethylens. Hohe Dichte, hohe Beständigkeit gegen chemische Einwirkung.



Poliéster / Polyester / Polyester / Polyester  
Elastómero fibra sintética. Se clasifica en Denier (D) Mayor Denier, mayor espesor y mayor resistencia mecánica 300D - 600D - 900D.  
Synthetic elastomer fibre. Classified in Denier (D) Greater Denier, thicker and greater mechanical resistance 300D - 600D - 900D.  
Fibre synthétique élastomère. Il est classé dans Denier (D) Denier, épaisseur supérieure et résistance mécanique supérieure 300D - 600D - 900D.  
Elastomer Kunstfaser. Wird nach Denier (D) klassifiziert. Je höher der Denier-Wert, desto größere Schichtdicke und höhere mechanische Festigkeit 300D - 600D - 900D.



Poliestireno / Polystyrene / Polystyrène / Polystyrol  
Termoplástico tipo commodity (standard). Polimerización del estireno. Transparente.  
A commodity (standard) thermoplastic. Polymerisation of styrene. Transparent.  
Produit de type thermoplastique (standard). Polymérisation du styrène. Transparent.  
Thermoplast für Bedarfsartikel (Standard). Polymerisierung des Styrols. Durchsichtig.



Poliétileno / Polyethylene / Polyéthylène / Polyethylen  
Termoplástico tipo commodity (standard). Polimerización del etileno.  
A commodity (standard) thermoplastic. Polymerisation of ethylene.  
Produit de type thermoplastique (standard). Polymérisation de l'éthylène.  
Thermoplast für Bedarfsartikel (Standard). Polymerisierung des Ethylens.



Poliestireno / Polystyrene / Poliestirène / Polystyrol  
Termoplástico tipo commodity (standard). Polimerización del estireno. PS de alto impacto.  
A commodity (standard) thermoplastic. Polymerisation of styrene. High-Impact PS.  
Produit de type thermoplastique (standard). Polymérisation du styrène. PS à fort impact.  
Thermoplast für Bedarfsartikel (Standard). Polymerisierung des Styrols. Sehr schlagzähes PS.



Poliuretano / Polyurethane / Poliuretane / Polyurethan  
Material esponjas caja herramientas.  
Spongy material toolboxes.  
Materiel mousse boites a outils.  
Material für die Schwämme der Werkzeugkästen



Cuero natural / Natural leather / Cuir naturel / Leder



Tayg, en la vanguardia de la innovación, también se ha adaptado a la producción del siglo XXI con materiales que ponen en valor las normativas de reciclaje a nivel mundial. Lo ha hecho a través de la fabricación de productos que permiten un uso racional de los materiales de desecho y, a su vez, un rápido reciclaje.

Además, fieles a dicho compromiso por la sostenibilidad y el medio ambiente, también utiliza materiales reciclados — tanto, que cuenta con una planta propia para reciclar materia prima—, hace un consumo eficiente de la energía, realiza tratamiento de residuos, y controla las emisiones atmosféricas. Actualmente es una de las únicas plantas de inyección de plástico en Europa con la ISO 14001 de cuidado del medio ambiente. Tayg.

**Future needs tools**

## CARACTERÍSTICAS

Features / Caractéristiques



Medidas en las tablas  
Measurements in tables  
Tableau de mesures  
Largo (L) x ancho (W) x alto (H)



Tamaño 33L  
Size 33L  
Mesures 33L



Soporta 120kg  
Supports up to 120kg  
Supporte 120kg



Resistente  
Resistant  
Resistant



Personalizable  
Customizable  
Personnalisable



Soporta 40kg por estante  
Up to 40 kg per shelf  
Jusqu'à 40 kg par étagère



Asa de Seguridad Antiapertura  
Anti Opening Lock System  
Poignée de sécurité anti ouverture



Montaje en 10 minutos  
Assembly in 10 minutes  
Assemblée en 10 minutes



Ligero  
Lightweight  
Léger



No se necesitan herramientas para su montaje  
No tools are needed for assembly  
Aucun outil n'est nécessaire pour l'assemblage



Impermeable  
Waterproof  
Imperméable



Alta resistencia  
High strength  
Haute resistance



Protección contra rayos UVA  
Protection against UV rays  
Protection contre les rayons uva



Protección para niños  
Protection for children  
Protection pour enfants



Grandes formatos  
Big sizes  
Gran formats



Homologados para transporte de mercancías peligrosas clases 3, 6.1, 8 y 9  
Approved for transporting Class 3, 6.1, 8, 9 dangerous goods  
Homologation pour le transport de marchandises dangereuses classées 3, 6.1, 8, 9



Colores especiales disponibles en todos los colores RAL bajo pedido. Consultar  
Special colours available in all RAL colours under request. Please send us your enquiry.  
Couleurs spéciales disponibles dans toute gamme de coloris RAL, sur demande.



Uso industrial  
Industrial use  
Usage industriel



Apto para uso alimentario  
Food graded  
Apte pour l'utilisation alimentaire



Personalizable con tecnología IML  
Customizable with IML technology  
Personnalisable avec la technologie IML



Eficiencia logística  
Logistic efficiency  
Efficacité logistique



Tecnología de RFID  
RFID technology  
Technologie RFID

Always at the forefront of innovation, Tayg has also adapted to 21st century production with materials that place value on global regulations on recycling. This has been made possible through the manufacturing of products that allow for the rational use of waste materials and, in turn, rapid recycling.

In addition, in line with that commitment to sustainability and the environment, the company also uses recycled materials—in fact, it has its own plant for recycling raw materials—makes efficient use of energy, treats waste, and controls atmospheric emissions. Currently is one of the unique plastic injection manufacturer in Europe with ISO14001 in care of the environment. Tayg

**Future needs tools**

Tayg est à l'avant-garde dans l'innovation. Nous adaptions nos procédés de fabrication des articles de bricolage et de quincaillerie à la production du XXIe s. avec des matériaux qui mettent en valeur les réglementations en matière de recyclage à l'échelle mondiale. Nous y parvenons au travers de la fabrication de produits qui permettent un usage rationnel des matériaux de recyclage et, à la fois, un recyclage rapide.

En outre, fidèles à cet engagement pour la durabilité et l'environnement, nous utilisons également des matériaux recyclés - au point de disposer de notre propre usine de recyclage de matières premières, nous faisons une consommation efficace de l'énergie, nous faisons le traitement des déchets et nous contrôlons les émissions atmosphériques. Tayg

**Future needs tools**

Tayg stellt die Avantgarde der Innovation dar und hat sich auch durch die Verwendung von Materialien, welche weltweit die Recyclingregelungen erfüllen, an die Produktion des 21. Jahrhunderts angepasst. Dies wird durch die Fertigung von Erzeugnissen ermöglicht, die eine zweckmäßige Nutzung der Abfallmaterialien und gleichzeitig ein rasches Recycling erlaubt.

Außerdem verwendet das Unternehmen im Sinne seines Engagements für Nachhaltigkeit und Umweltschutz auch Recyclingmaterial - und verfügt dafür über eine eigene Anlage zum Recycling von Rohstoffen, nutzt Energie effizient, behandelt seine Abfälle und kontrolliert die Luftemissionen. Es ist derzeit eine der wenigen Werke von Kunststoffspritzguss in Europa mit Umweltschutz nach ISO 14001. Tayg

**Future needs tools**

pág. 10



## CAJA DE HERRAMIENTAS Y ESTUCHES

Tool boxes and organizers  
Boîtes à outils et coffrets  
Werkzeugkoffer und  
Kleinteileaufbewahrung

pág. 48



## PRODUCTOS DE ORDENACIÓN

Arrangement products  
Produits de rangement  
Produkten für Aufbewahrung

pág. 74

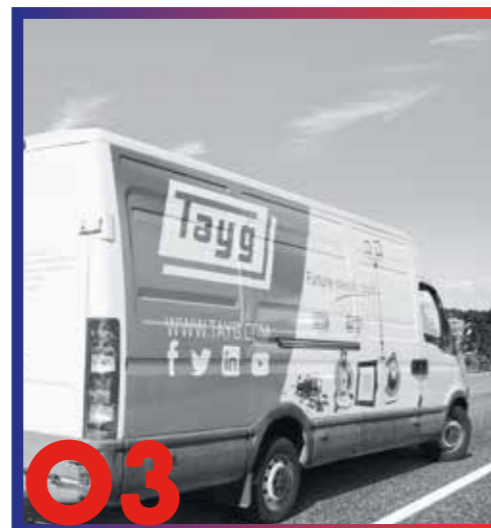

## TAYG CAR

Tayg Car  
Tayg Car  
Tayg Car

pág. 78



## PRODUCTOS DE ORDENACIÓN

Arrangement products  
Produits de rangement  
Produkten für Aufbewahrung

pág. 82



## ECO TAYG

Eco Tayg  
Eco Tayg  
Eco Tayg

pág. 94



## ACCESORIOS ELÉCTRICOS

Electrical accessories  
Accessoires électriques  
Elektrozubehör

pág. 116



## ACCESORIOS PARA LA CONSTRUCCIÓN

Building accessories  
Accessoires pour la  
construction  
Bauzubehör

pág. 154



## LISTA DE PACKING

Packing list  
Liste d'emballage  
Verpackungsliste



# ÍNDICE

INDEX / INDEX / INHALTSVERZEICHNIS

# CAJAS DE HERRAMIENTAS Y ESTUCHES

Tool boxes and organizers | Boîtes à outils et coffrets  
Werkzeugkoffer und Kleinteileaufbewahrung

# 01



## ESTUCHES CON SEPARADORES FIJOS **12**

Organizers with fixed distribution  
Coffret à casiers fixes  
Organizers mit fester Facheinteilug



## ESTUCHES CON SEPARADORES MÓVILES **14**

Organizers with mobile dividers  
Coffret à séparateurs  
Kleinteilerkoffer mit flexibler Facheinteilug



## ESTUCHES CON CAJONES EXTRAÍBLES | CAJONES EXTRAÍBLES DE 50 Y 80 **16**

Organizers with mobile drawers |  
Removable drawers 50 and 80  
Coffret à compartiments amovibles |  
Compartiments amovibles de 50 et 80  
Organizers mit herausnehmbaren Einsätze |  
Herausnehmbaren Fächern von 50 und 80



## MALETAS HERRAMIENTAS ELÉCTRICAS **18**

Plastic tool boxes  
Mallettes pour outillage électrique  
Elektrowerkzeuge koffer



## CAJAS DE HERRAMIENTA DE PLÁSTICO **22**

Plastic tool boxes  
Boîtes à outils plastiques  
Werkzeugkoffer aus Kunststoff



## CAJA METÁLICA | CAJA DE PLÁSTICO **24**

Metallic box | Plastic box  
Boîte en métal | Boîte en plastique  
Metallgehäuse | Werkzeugkoffer aus  
Metall und Kunststoff



## CAJAS DE HERRAMIENTAS DE PLÁSTICO - ALUMINIO **26**

Plastic - aluminium tool boxes  
Boîtes à outils plastiques et aluminium  
Werkzeugkoffer aus Kunststoff und  
Aluminium



## CAJAS DE HERRAMIENTAS DE PLÁSTICO - ALUMINIO | COFRE HERRAMIENTAS MOVIL **30**

Plastic - aluminium tool boxes |  
Mobile tool chest  
Boîtes à outils plastiques et aluminium |  
Coffre a outils mobile  
Werkzeugkoffer aus Kunststoff und  
Aluminium | Mobile Werkzeugbox



## TRAIL BOX / SAFETY TOOL BOX **32**

Trail box - Safety tool box  
Servanter de chantier - Safety tool box  
Trail-Box - Safety tool box



## TRAIL BOX PRO **36**

Trail box pro  
Servanter de chantier pro  
Trail-Box pro



## CAJA DE HERRAMIENTAS COLECCIÓN BÁSICA **38**

Basic line tool boxes  
Boîtes à outils Basic Line  
Werkzeugkoffer Basic-Kollektion



## BOLSAS HERRAMIENTAS | CINTURÓN HERRAMIENTAS **42**

Tool bags | Tool belt  
Sacs à outils | Ceintures outils  
Werkzeugtaschen | Werkzeuggürtel



## MOCHILA HERRAMIENTAS **44**

Backpack  
Sacs à dos à outils  
Werkzeugrucksack



## CINTURONES Y SOPORTES DE CUERO **46**

Leather belts and holders  
Ceintures et supports à cuir  
Gestell und Ledergürtel



# ESTUCHES CON SEPARADORES FIJOS

Organizers with fixed distribution / Coffret à casiers fixes

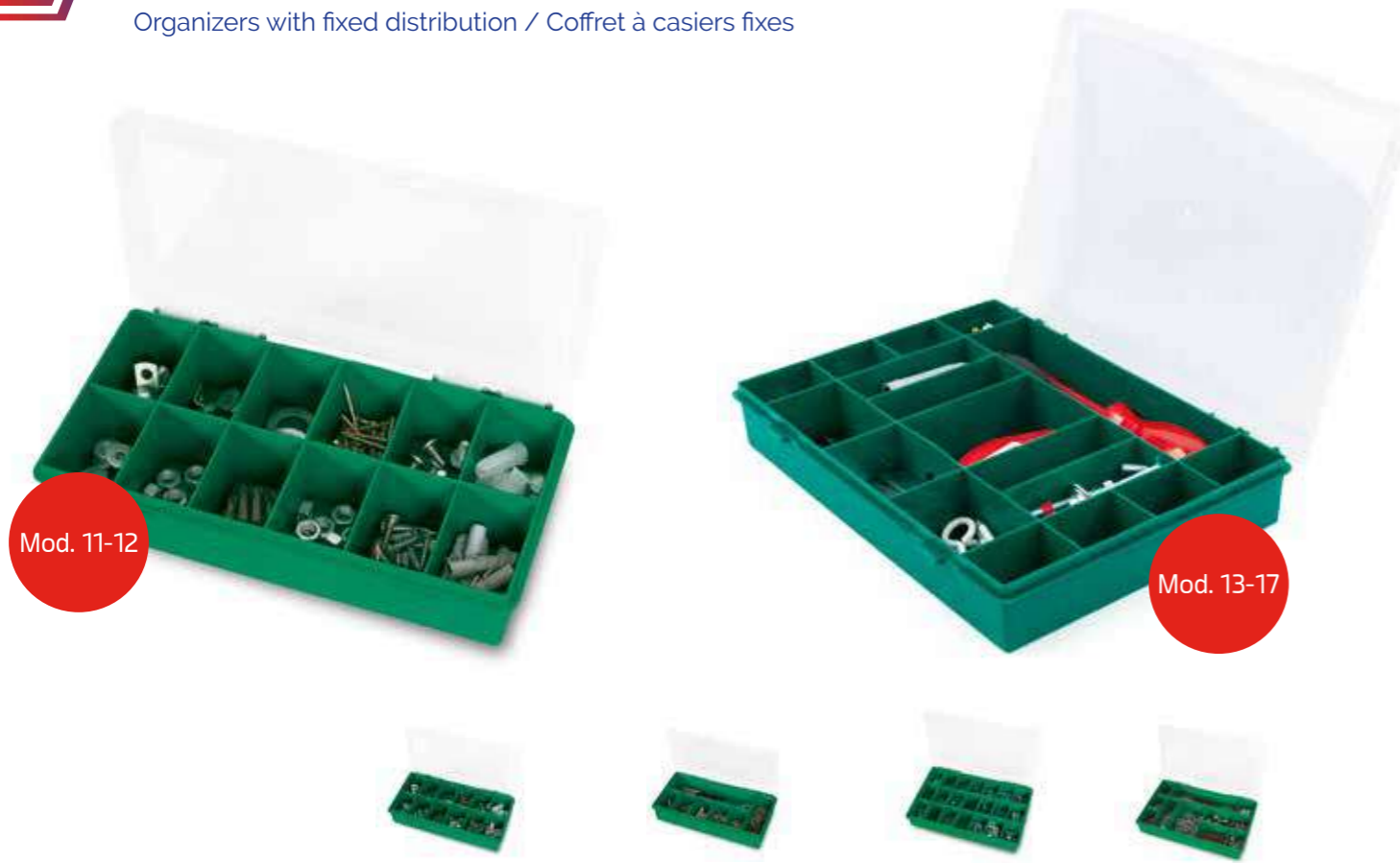

Mod. 11-12

Mod. 13-17

| MODELO<br>Model / Modèle                                     | 11-12             | 11-7              | 12-21             | 12-11             |
|--|-------------------|-------------------|-------------------|-------------------|
| CÓDIGO<br>Code / Code  | 050107            | 051104            | 060106            | 061103            |
| MEDIDAS<br>Sizes / Mesures                                   | 250 x 140 x 54 mm | 250 x 140 x 54 mm | 290 x 195 x 54 mm | 290 x 195 x 54 mm |
| MATERIAL<br>Material / Matériau                              | PP                | PP                | PP                | PP                |
| EMBALAJE / UNIDADES<br>Packing / Units<br>Emballage / Unités | 6                 | 6                 | 6                 | 6                 |



| MODELO<br>Model / Modèle                                     | 33-15             | 33-9              | 13-32             | 13-17             |
|--|-------------------|-------------------|-------------------|-------------------|
| CÓDIGO<br>Code / Code  | 008009            | 009006            | 070105            | 071102            |
| MEDIDAS<br>Sizes / Mesures                                   | 215 x 207 x 42 mm | 215 x 207 x 42 mm | 330 x 247 x 54 mm | 330 x 247 x 54 mm |
| MATERIAL<br>Material / Matériau                              | PP                | PP                | PP                | PP                |
| EMBALAJE / UNIDADES<br>Packing / Units<br>Emballage / Unités | 12                | 12                | 6                 | 6                 |

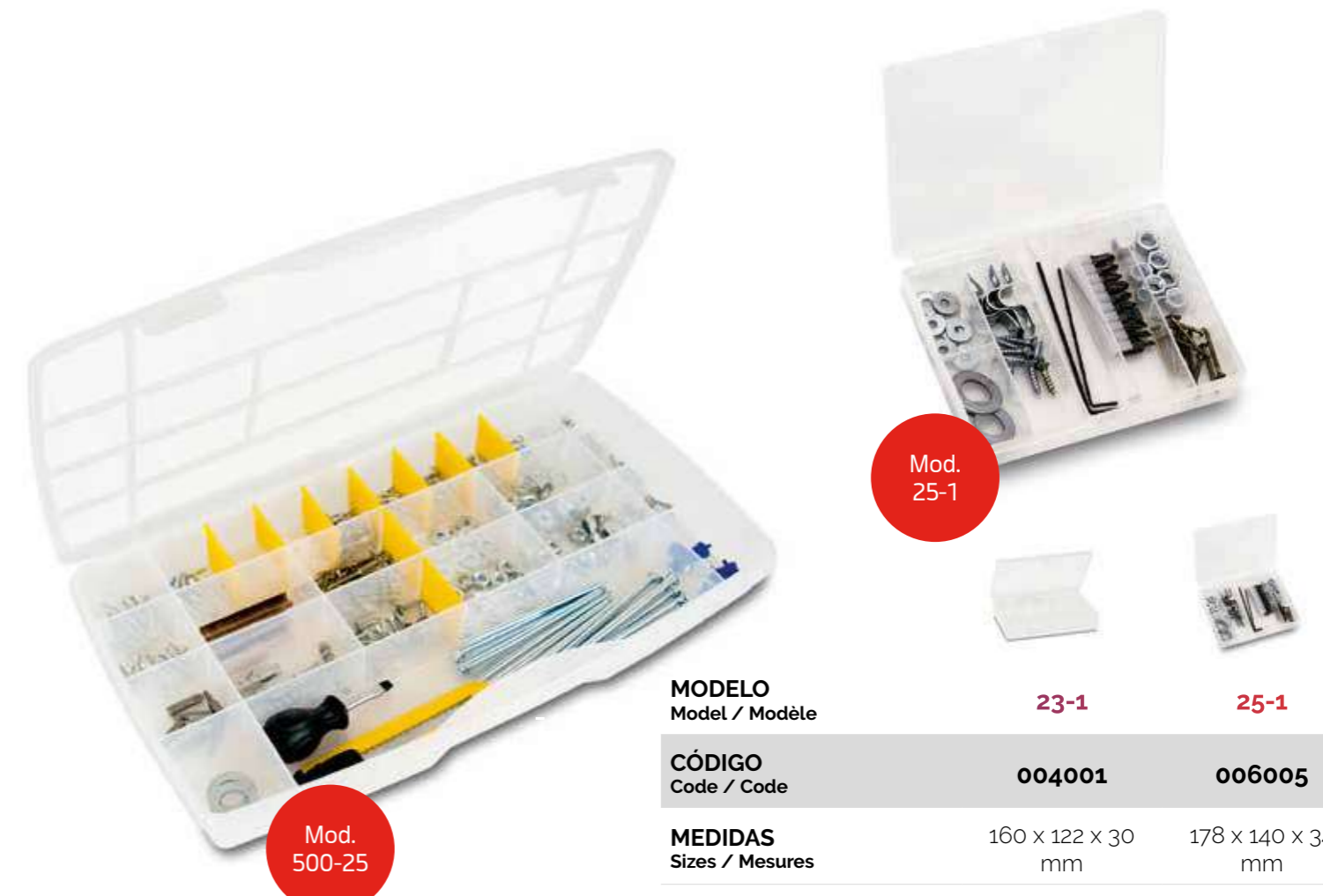

Mod. 500-25

Mod. 25-1

| MODELO<br>Model / Modèle                                     | 23-1              | 25-1              |
|--|-------------------|-------------------|
| CÓDIGO<br>Code / Code  | 004001            | 006005            |
| MEDIDAS<br>Sizes / Mesures                                   | 160 x 122 x 30 mm | 178 x 140 x 34 mm |
| MATERIAL<br>Material / Matériau                              | PP                | PP                |
| EMBALAJE / UNIDADES<br>Packing / Units<br>Emballage / Unités | 24                | 24                |



| MODELO<br>Model / Modèle                                     | 170-7                                      | 240-12                                     | 300-16            | 450-25                                     | 500-25                                     |
|--|--|--|-------------------|--|--|
| CÓDIGO<br>Code / Code  | 012006                                     | 013003                                     | 014000            | 010002                                     | 011009                                     |
| MEDIDAS<br>Sizes / Mesures                                   | 170 x 114 x 36 mm                          | 240 x 155 x 41 mm                          | 300 x 199 x 46 mm | 387 x 230 x 49 mm                          | 440 x 244 x 49 mm                          |
| CONTIENE<br>Contained / Contient                             | Eurohole<br>With eurohole<br>Avec eurohole | Eurohole<br>With eurohole<br>Avec eurohole | —                 | 8 Separadores<br>Dividers /<br>Séparateurs | 8 Separadores<br>Dividers /<br>Séparateurs |
| MATERIAL<br>Material / Matériau                              | PP   | PP   | PP                | PP   | PP   |
| EMBALAJE / UNIDADES<br>Packing / Units<br>Emballage / Unités | 12   | 12   | 6                 | 6  | 6  |

Cajas de herramientas y estuches  
Tool boxes and organizers  
Boîtes à outils et coffrets

Productos de ordenación  
Arrangement products  
Produits de rangement

Tayg Car  
Tayg Car  
Tayg Car

Colección hogar  
Home collection  
Boîtes de rangement Home

Eco Tayg  
Eco Tayg  
Eco Tayg

Tayg Light  
Tayg Light  
Tayg Light

Tayg Build  
Tayg Build  
Tayg Build

Lista de packing  
Packing list  
Liste d'emballage





## ESTUCHES CON SEPARADORES MÓVILES

Organizers with mobile dividers / Coffret à séparateurs



Mod. 47-26

Doble cierre  
Double closure  
Double fermeture

**Colores.** Tapa transparente, separadores amarillos y base azul  
**Colours.** Clear lid, yellow dividers and blue base.  
**Couleurs.** Couvercle transparent, séparateurs jaunes et base bleue

**Medidas.** 460mm (L) x 350mm (A) x 81mm (H)  
**Dimensions.** 460mm x 350mm x 81mm  
**Dimensions.** 460mm x 350mm x 81mm

21 separadores móviles. Compartimentos diseñados para que no se mezclen.  
Organiser case with 21 movable dividers.  
Casier à séparateurs amovibles, avec 21 séparateurs



Mod. 47-26



| MODELO<br>Model / Modèle  | 45-26                                      | 46-26                                      | 47-26                                      | 48-26   | 49-16                                      |
|---|--|--|--|---|--|
| CÓDIGO<br>Code / Code   | 145001                                     | 146008                                     | 147005                                     | 148002  | 049002                                     |
| MEDIDAS LxAxH<br>Sizes / Mesures                                | 312 x 238 x 51 mm                          | 378 x 290 x 61 mm                          | 460 x 350 x 81 mm                          | 460 x 350 x 81 mm   | 490 x 250 x 80 mm                          |
| CONTIENE<br>Contained / Contient                                | 21 Separadores<br>Dividers/<br>Séparateurs | 21 Separadores<br>Dividers/<br>Séparateurs | 21 Separadores<br>Dividers/<br>Séparateurs | 21 Separadores<br>Dividers /<br>Séparateurs   | 12 Separadores<br>Dividers/<br>Séparateurs |
| MATERIAL<br>Material / Matériau                                 | PP   | PP   | PP   | Base, separadores y cierres: PP.<br>Base, dividers and locks: PP.<br>Base, Séparateurs<br>et attaches: PP.<br>Tapa/Cover/Couvercle:<br>POLICARBONATO (PC) |  |
| EMBALAJE /<br>UNIDADES<br>Packing / Units<br>Emballage / Unités | 6  | 6  | 5  | 5   | 5  |

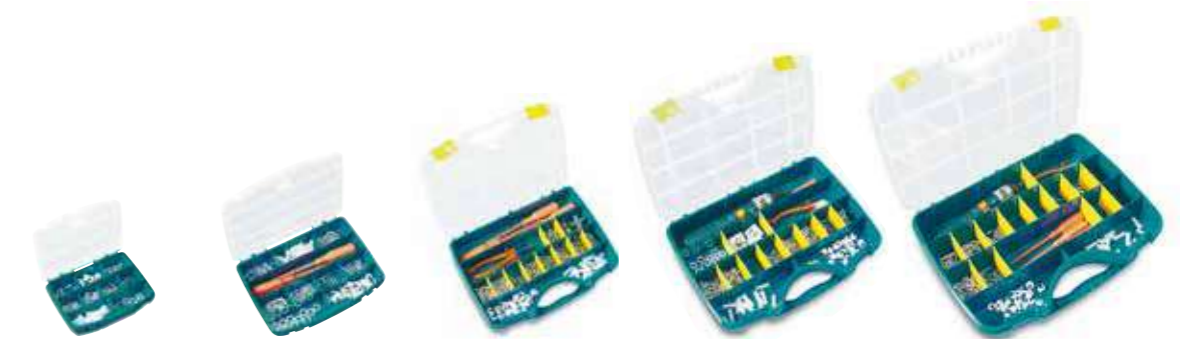

| MODELO<br>Model / Modèle                                     | 20-9              | 21-10             | 22-26                                       | 23-26                                       | 24-26                                       |
|--|-------------------|-------------------|---|---|---|
| CÓDIGO<br>Code / Code  | 020001            | 021008            | 022005                                      | 023002                                      | 024009                                      |
| MEDIDAS LxAxH<br>Sizes / Mesures                             | 190 x 150 x 42 mm | 256 x 192 x 42 mm | 312 x 238 x 51 mm                           | 388 x 290 x 61 mm                           | 460 x 350 x 81 mm                           |
| CONTIENE<br>Contained / Contient                             | —                 | —                 | 21 Separadores<br>Dividers /<br>Séparateurs | 21 Separadores<br>Dividers /<br>Séparateurs | 21 Separadores<br>Dividers /<br>Séparateurs |
| MATERIAL<br>Material / Matériau                              | PP                | PP                | PP  | PP  | PP  |
| EMBALAJE / UNIDADES<br>Packing / Units<br>Emballage / Unités | 12                | 12                | 6   | 6   | 5   |



## ESTUCHES CON CAJONES EXTRAÍBLES

Organizers with mobile drawers / Coffret à compartiments amovibles

### ESTUCHES CON CAJONES EXTRAÍBLES 50

Organizers with removable drawers 50  
Coffret à compartiments amovibles 50



| MODELO<br>Model / Modèle  | 430/50/50   | 430/50/25   | 430/50/0   |
|---|---|---|--|
| CÓDIGO<br>Code / Code   | 030000  | 031007  | 030406   |
| MEDIDAS<br>Sizes / Mesures                                      | 430 x 370 x 55 mm   | 430 x 370 x 55 mm   | 430 x 370 x 55 mm                                      |
| CONTIENE<br>Contained / Contient                                | Cajones 50 / A50<br>Drawers / Tiroirs   | Cajones 10/A50<br>Drawers 10/B50<br>Tiroirs 5/C50   | Vacio<br>Empty<br>Vide                                 |
| MATERIAL<br>Material / Matériau                                 | Base PP<br>Base / Base<br>Tapa PS<br>Cover / Couvercle<br>Cajones PS /<br>Drawers / Tiroirs | Base PP<br>Base / Base<br>Tapa PS<br>Cover / Couvercle<br>Cajones PS /<br>Drawers / Tiroirs | Base PP<br>Base / Base<br>Tapa PS<br>Cover / Couvercle |
| EMBALAJE /<br>UNIDADES<br>Packing / Units<br>Emballage / Unités | 4   | 4   | 4  |



### ESTUCHES CON CAJONES EXTRAÍBLES 80

Organizers with removable drawers 80  
Coffret à compartiments amovibles 80



| MODELO<br>Model / Modèle  | 430/80/25   | 430/80/13   | 430/80/0   |
|---|---|---|--|
| CÓDIGO<br>Code / Code   | 032004  | 033001  | 032400   |
| MEDIDAS<br>Sizes / Mesures                                      | 430 x 370 x 85 mm   | 430 x 370 x 85 mm   | 430 x 370 x 85 mm                                      |
| CONTIENE<br>Contained / Contient                                | Cajones 25/B80<br>Drawers / Tiroirs   | Cajones 5/B80<br>Drawers 6/C80<br>Tiroirs 2/D80   | Vacio<br>Empty<br>Vide                                 |
| MATERIAL<br>Material / Matériau                                 | Base PP<br>Base / Base<br>Tapa PS<br>Cover / Couvercle<br>Cajones PS /<br>Drawers / Tiroirs | Base PP<br>Base / Base<br>Tapa PS<br>Cover / Couvercle<br>Cajones PS /<br>Drawers / Tiroirs | Base PP / Base /<br>Base<br>Tapa PS<br>Cover/Couvercle |
| EMBALAJE /<br>UNIDADES<br>Packing / Units<br>Emballage / Unités | 4   | 4   | 4  |



## CAJONES EXTRAÍBLES DE 50 Y 80

Removable drawers 50 and 80 / Compartiments amovibles de 50 et 80

### ESTUCHE CON CAJONES EXTRAÍBLES

Organizers with removable drawers  
Coffret à compartiments amovibles



| MODELO<br>Model / Modèle  | 330/50/32   | 330/50/16   | 330/50/0   |
|---|---|---|--|
| CÓDIGO<br>Code / Code   | 034008  | 035005  | 034404   |
| MEDIDAS<br>Sizes / Mesures                                      | 330 x 247 x 54 mm   | 330 x 247 x 54 mm   | 330 x 247 x 54 mm                                      |
| CONTIENE<br>Contained / Contient                                | Cajones 32/A50<br>Drawers / Tiroirs   | Cajones 8/A50<br>Drawers 4/B50<br>Tiroirs 4/C50   | Cajones Vacío<br>Boxes Empty<br>Tiroirs Vide           |
| MATERIAL<br>Material / Matériau                                 | Base PP<br>Base / Base<br>Tapa PP<br>Cover / Couvercle<br>Cajones PS<br>Drawers / Tiroirs | Base PP<br>Base / Base<br>Tapa PP<br>Cover / Couvercle<br>Cajones PS<br>Drawers / Tiroirs | Base PP<br>Base / Base<br>Tapa PP<br>Cover / Couvercle |
| EMBALAJE /<br>UNIDADES<br>Packing / Units<br>Emballage / Unités | 6   | 6   | 6  |



### CAJONES EXTRAÍBLES 50

Removable drawers 50  
Compartiments amovibles 50



Accesorios  
Accessories / Accessoires

| MODELO<br>Model / Modèle                                     | A50                               | B50                               | C50                               |
|--|-----------------------------------|-----------------------------------|-----------------------------------|
| CÓDIGO<br>Code / Code  | 040009                            | 041006                            | 042003                            |
| MEDIDAS<br>Sizes / Mesures                                   | 55 x 39 x 47 mm                   | 79 x 55 x 47 mm                   | 109 x 79 x 47 mm                  |
| MATERIAL<br>Material / Matériau                              | Cajones PS /<br>Drawers / Tiroirs | Cajones PS /<br>Drawers / Tiroirs | Cajones PS /<br>Drawers / Tiroirs |
| EMBALAJE / UNIDADES<br>Packing / Units<br>Emballage / Unités | 300                               | 150                               | 75                                |

### CAJONES EXTRAÍBLES 80

Removable drawers 80  
Compartiments amovibles 80

| MODELO<br>Model / Modèle                                     | B80                               | C80                               | D80                               |
|--|-----------------------------------|-----------------------------------|-----------------------------------|
| CÓDIGO<br>Code / Code  | 043000                            | 044007                            | 045004                            |
| MEDIDAS<br>Sizes / Mesures                                   | 79 x 55 x 76 mm                   | 109 x 79 x 76 mm                  | 157 x 109 x 76 mm                 |
| MATERIAL<br>Material / Matériau                              | Cajones PS /<br>Drawers / Tiroirs | Cajones PS /<br>Drawers / Tiroirs | Cajones PS /<br>Drawers / Tiroirs |
| EMBALAJE / UNIDADES<br>Packing / Units<br>Emballage / Unités | 90                                | 45                                | 21                                |



# MALETAS HERRAMIENTAS ELÉCTRICAS

Cases for electrical tools / Mallettes pour outillage électrique



\* Colores especiales disponibles en todos los colores RAL bajo pedido. Consultar Special colours available in all RAL colours under request. Please send us your enquiry. Couleurs spéciales disponibles dans toute gamme de coloris RAL, sur demande.



Mod. 40



Mod. 41



Mod. 42

Protección para contenido en todos los modelos  
All models have content protection  
Protection pour le contenu dans tous les modèles



| MODELO<br>Model / Modèle  | 40                   | 41   | 42   |
|---|----------------------|--|--|
| CÓDIGO<br>Code / Code   | 140006               | 141003   | 142000   |
| MEDIDAS<br>Sizes / Mesures                                      | 385 x 330 x 130 mm   | 385 x 330 x 130 mm                                       | 385 x 330 x 130 mm   |
| CONTIENE<br>Contained / Contient                                | Vacio / Empty / Vide | 1 Estuche / Box / Coffret                                | 1 Bandeja<br>Tray / Panier porte-outils                              |
| MATERIAL<br>Material / Matériau                                 | PP                   | PP   | PP   |
| COLOR<br>Colour / Couleur                                       | ●                    | ● caja / tool box / boîte<br>● estuche/organizer/coffret | ⊙ ● caja / tool box / boîte<br>● bandeja/tray<br>panier porte-outils |
| EMBALAJE /<br>UNIDADES<br>Packing / Units<br>Emballage / Unités | 7                    | 7  | 7  |



Mod. 43



Mod. 44



Mod. 44-B

Protección para contenido en todos los modelos  
All models have content protection  
Protection pour le contenu dans tous les modèles



| MODELO<br>Model / Modèle  | 43                                       | 44                    | 44-B   |
|---|--|-----------------------|--|
| CÓDIGO<br>Code / Code   | 143007                                   | 144004                | 144998   |
| MEDIDAS<br>Sizes / Mesures                                      | 401 x 352 x 156 mm                       | 430 x 370 x 140 mm    | 430 x 370 x 140 mm   |
| CONTIENE<br>Contained / Contient                                | 20 Separadores<br>Dividers / Séparateurs | Vacio<br>Empty / Vide | 1 Bandeja<br>Tray / Panier porte-outils                              |
| MATERIAL<br>Material / Matériau                                 | PP                                       | PP                    | PP   |
| COLOR<br>Colour / Couleur                                       | ●  | ●                     | ⊙ ● caja / tool box / boîte<br>● bandeja<br>tray/panier porte-outils |
| EMBALAJE /<br>UNIDADES<br>Packing / Units<br>Emballage / Unités | 6  | 4                     | 4  |



# CAJAS DE HERRAMIENTAS DE PLÁSTICO

Plastic tool boxes  
Boîtes à outils plastiques





# CAJAS DE HERRAMIENTAS DE PLÁSTICO

Plastic tool boxes / Boîtes à outils plastiques



\* Colores especiales disponibles en todos los colores RAL bajo pedido. Consultar Special colours available in all RAL colours under request. Please send us your enquiry. Couleurs spéciales disponibles dans toute gamme de coloris RAL, sur demande.



Mod. 11 - 12 soporta 120kg  
Mod. 11 - 12 supports up to 120kg  
Mod. 11 - 12 suporte 120kg



| MODELO<br>Model / Modèle | 20 | 21 | 22 | 23 | 24 | 25 |
|--------------------------|----|----|----|----|----|----|
|--------------------------|----|----|----|----|----|----|

| CÓDIGO<br>Code / Code | 120008 | 121005 | 122002 | 123009 | 124006 | 125003 |
|-----------------------|--------|--------|--------|--------|--------|--------|
|-----------------------|--------|--------|--------|--------|--------|--------|

| MEDIDAS<br>Sizes / Mesures | 310 x 160 x 130 mm<br>12,20 x 6,30 x 5,12 in | 310 x 160 x 130 mm<br>12,20 x 6,30 x 5,12 in | 356 x 184 x 163 mm<br>14,02 x 7,24 x 6,42 in | 356 x 184 x 163 mm<br>14,02 x 7,24 x 6,42 in | 400 x 206 x 188 mm<br>15,75 x 8,11 x 7,40 in | 400 x 206 x 188 mm<br>15,75 x 8,11 x 7,40 in |
|----------------------------|--|--|--|--|--|--|
|----------------------------|--|--|--|--|--|--|

| CONTIENE<br>Contained / Contient | - | 1 Bandeja<br>Tray / Panier<br>porte-outils | 1 Bandeja<br>Tray / Panier<br>porte-outils | 1 Bandeja/Tray<br>Panier<br>porte-outils<br>1 Estuche<br>Organize<br>Coffrett | 1 Bandeja<br>Tray<br>Panier porte-outils | 1 Bandeja<br>Tray<br>Panier porte-outils<br>1 Estuche<br>Organizer /Coffrett |
|----------------------------------|---|--|--|---|--|--|
|----------------------------------|---|--|--|---|--|--|

| MATERIAL<br>Material / Matériau | PP | PP | PP | PP | PP | PP |
|---------------------------------|----|----|----|----|----|----|
|---------------------------------|----|----|----|----|----|----|

| EMBALAJE /<br>UNIDADES<br>Packing / Units<br>Emballage / Unités | 10 | 10 | 6 | 6 | 6 | 6 |
|---|----|----|---|---|---|---|
|---|----|----|---|---|---|---|



| MODELO<br>Model / Modèle | 9 | 10 | 11 | 12 |
|--------------------------|---|----|----|----|
|--------------------------|---|----|----|----|

| CÓDIGO<br>Code / Code | 109003 | 110009 | 111006 | 112003 |
|-----------------------|--------|--------|--------|--------|
|-----------------------|--------|--------|--------|--------|

| MEDIDAS<br>Sizes / Mesures | 290 x 170 x 127 mm<br>11,42 x 6,69 x 5 in | 290 x 170 x 127 mm<br>11,42 x 6,69 x 5 in | 356 x 192 x 150 mm<br>14,02 x 7,56 x 5,91 in | 400 x 217 x 166 mm<br>15,75 x 8,54 x 6,53 in |
|----------------------------|---|---|--|--|
|----------------------------|---|---|--|--|

| CONTIENE<br>Contained / Contient | Vacío / Empty / Vide | 1 Bandeja<br>Tray / Panier<br>porte-outils | 1 Bandeja<br>Tray / Panier<br>porte-outils | 1 Bandeja<br>Tray / Panier<br>porte-outils |
|----------------------------------|----------------------|--|--|--|
|----------------------------------|----------------------|--|--|--|

| MATERIAL<br>Material / Matériau | PP | PP | PP | PP |
|---------------------------------|----|----|----|----|
|---------------------------------|----|----|----|----|

| EMBALAJE /<br>UNIDADES<br>Packing / Units<br>Emballage / Unités | 10 | 10 | 6 | 6 |
|---|----|----|---|---|
|---|----|----|---|---|



Bandeja con doble capacidad  
Double capacity tray  
Plateau avec double capacité



\* Colores especiales disponibles en todos los colores RAL bajo pedido. Consultar Special colours available in all RAL colours under request. Please send us your enquiry. Couleurs spéciales disponibles dans toute gamme de coloris RAL, sur demande.



Soporta 120kg  
Supports up to 120kg  
Supporte 120kg



\*Opción Box Pallet  
Box Pallet Option  
Option box palette

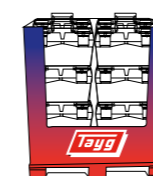

| MODELO<br>Model / Modèle | 15 | 16 | 17 | 18 | 19 |
|--------------------------|----|----|----|----|----|
|--------------------------|----|----|----|----|----|

| CÓDIGO<br>Code / Code | 115004 | 116001 | 117008 | 118005 | 119002 |
|-----------------------|--------|--------|--------|--------|--------|
|-----------------------|--------|--------|--------|--------|--------|

| MEDIDAS<br>Sizes / Mesures | 500 x 258 x 255 mm<br>19,68 x 10,16 x 10,04 in | 500 x 258 x 255 mm<br>19,68 x 10,16 x 10,04 in | 580 x 290 x 290 mm<br>22,83 x 11,42 x 11,42 in | 580 x 290 x 290 mm<br>22,83 x 11,42 x 11,42 in | 580 x 290 x 290 mm<br>22,83 x 11,42 x 11,42 in |
|----------------------------|--|--|--|--|--|
|----------------------------|--|--|--|--|--|

| CONTIENE<br>Contained / Contient | 1 Bandeja / Tray /<br>Panier porte-outils | 1 Bandeja / Tray /<br>Panier porte-outils<br>1 Estuche<br>Organizer / Coffrett | 1 Bandeja / Tray /<br>Panier porte-outils | 1 Bandeja / Tray /<br>Panier porte-outils<br>1 Estuche<br>Organizer / Coffrett | 1 Bandeja doble /<br>Tray<br>Panier porte-outils<br>1 Estuche<br>Organizer / Coffrett |
|----------------------------------|---|--|---|--|---|
|----------------------------------|---|--|---|--|---|

| MATERIAL<br>Material / Matériau | PP<br>CIERRES METÁLICOS<br>Metallic locks<br>Fermetures Métalliques | PP<br>CIERRES METÁLICOS<br>Metallic locks<br>Fermetures Métalliques | PP<br>CIERRES METÁLICOS<br>Metallic locks<br>Fermetures Métalliques | PP<br>CIERRES METÁLICOS<br>Metallic locks<br>Fermetures Métalliques | PP<br>CIERRES METÁLICOS<br>Metallic locks<br>Fermetures Métalliques |
|---------------------------------|---|---|---|---|---|
|---------------------------------|---|---|---|---|---|

| EMBALAJE /<br>UNIDADES<br>Packing / Units<br>Emballage / Unités | 3 | 3 | 3 | 3 | 3 |
|---|---|---|---|---|---|
|---|---|---|---|---|---|

| UNIDAD BOX<br>PALLET<br>Box - Pallet Unit<br>Unité dans box palette | 24 | 24 | 24 | 24 | 24 |
|---|----|----|----|----|----|
|---|----|----|----|----|----|

| MEDIDAS BOX<br>PALET<br>Box - Pallet Unit<br>Mesures de la box<br>palette | 1000 x 772 x 1016<br>mm | 1000 x 772 x 1016<br>mm | 1160 x 804 x 1160<br>mm | 1160 x 804 x 1160<br>mm | 1160 x 804 x 1160<br>mm |
|---|-------------------------|-------------------------|-------------------------|-------------------------|-------------------------|
|---|-------------------------|-------------------------|-------------------------|-------------------------|-------------------------|



## CAJA METÁLICA / CAJA DE PLÁSTICO

Metallic box / Boîte en métal | Plastic box / Boîte en plastique

**Material utilizado:** Polipropileno.

**Material:** Polypropylene.

**Matériau employé :** Polypropylène

**Color.** Caja negra, bandeja roja, cerraduras y asa.

**Colour.** Black case, red tray, closures and handle

**Couleur.** Coffret noir, plateau, fermetures et poignée rouges



Incluye bandeja organizadora  
Includes organiser tray  
Contient un plateau organisateur



Mod. 32

Con asa de seguridad antiapertura  
With anti-open safety handle  
Avec poignée de sécurité anti-ouverture

Regla métrica en la tapa  
Ruler on the lid  
Règle graduée dans le couvercle

Doble cierre y posible cierre manual con candado (no incluido)  
Double closure and possibility of locking with a padlock (not included)  
Double fermeture et fermeture manuelle possible par cadenas (non inclus)

Soporta hasta 120kg  
Withstands up to 120kg  
Supporte jusqu'à 120kg

**Medidas.** 480mm (L) x 258mm (A) x 255mm (H)

**Dimensions.** 480x258x255mm

**Dimensions.** 480x258x255mm

## PROFESIONAL



\* Colores especiales disponibles en todos los colores RAL bajo pedido. Consultar  
Special colours available in all RAL colours under request. Please send us your enquiry.  
Couleurs spéciales disponibles dans toute gamme de coloris RAL, sur demande.



Soporta 120kg  
Supports up to 120kg  
Supporte 120kg



Asa de Seguridad Antiapertura  
Anti Opening Lock System  
Poignée de sécurité anti ouverture



**MODELO**  
Model / Modèle

403

**CÓDIGO**  
Code / Code

185007

**MEDIDAS LxAxH**  
Sizes / Mesures

404 x 200 x 240  
15,91 x 7,87 x 9,45 in

**CONTIENE**  
Contained / Contient

2 Bandejas  
Tray / Panier porte-outils

**MATERIAL**  
Material / Matériau

Chapa acero + pintura epoxi  
Sheet steel+ epoxy paint  
Plaque acier + peinture epoxi

**EMBALAJE / UNIDADES**  
Packing / Units  
Emballage / Unités

1



**MODELO**  
Model / Modèle

30

31

32

33

**CÓDIGO**  
Code / Code

130007

131004

132001

133008

**MEDIDAS LxAxH**  
Sizes / Mesures

445 x 235 x 230 mm  
17,52 x 9,25 x 9,05 in

445 x 235 x 230 mm  
17,52 x 9,25 x 9,05 in

480 x 258 x 255 mm  
18,90 x 10,16 x 10,04 in

480 x 258 x 255 mm  
18,90 x 10,16 x 10,04 in

**CONTIENE**  
Contained / Contient

1 Bandeja / Tray /  
Panier porte-outils

1 Bandeja / Tray /  
Panier porte-outils  
1 Estuche  
Organizer / Coffrett

1 Bandeja / Tray /  
Panier porte-outils

1 Bandeja / Tray /  
Panier porte-outils  
1 Estuche  
Organizer / Coffrett

**MATERIAL**  
Material / Matériau

PP

PP

PP

PP

**EMBALAJE / UNIDADES**  
Packing / Units  
Emballage / Unités

6

6

3

3



# CAJAS DE HERRAMIENTAS DE PLÁSTICO - ALUMINIO

Plastic - aluminium tool boxes / Boîtes à outils plastiques et aluminium

**PROFESIONAL**



\* Colores especiales disponibles en todos los colores RAL bajo pedido. Consultar Special colours available in all RAL colours under request. Please send us your enquiry. Couleurs spéciales disponibles dans toute gamme de coloris RAL, sur demande.



Soporta 120kg Supports up to 120kg Suporte 120kg



Asa de Seguridad Antiapertura Anti Opening Lock System Poignée de sécurité anti ouverture



Mod. 35

Bandeja con doble capacidad Two-level tray Plateau avec double capacité

\* 149009 Accesorio-cinta y soportes Accessory-strap, frame Accessoires, bandeau et supports



34-1B



34



35



36

| MODELO<br>Model / Modèle  | 34-1B  | 34   | 35  | 36   |
|---|--|--|---|--|
| CÓDIGO<br>Code / Code   | 134999   | 134005   | 135002  | 136009   |
| MEDIDAS<br>Sizes / Mesures                                      | 580 x 285 x 290 mm<br>22,83 x 11,22 x 11,42 in | 580 x 285 x 290 mm<br>22,83 x 11,22 x 11,42 in                               | 580 x 285 x 290 mm<br>22,83 x 11,22 x 11,42 in                                  | 580 x 285 x 290 mm<br>22,83 x 11,22 x 11,42 in   |
| CONTIENE<br>Contained / Contient                                | 1 Bandeja / Tray<br>Panier porte-outils        | 1 Bandeja / Tray<br>Panier porte-outils<br>1 Estuche<br>Organizer / Coffrett | 2 Bandejas / Tray /<br>Panier porte-outils<br>1 Estuche<br>Organizer / Coffrett | 1 Bandeja doble<br>Double tray / Panier<br>porte-outils<br>1 Estuche<br>Organizer / Coffrett |
| MATERIAL<br>Material / Matériau                                 | PP   | PP   | PP  | PP   |
| EMBALAJE /<br>UNIDADES<br>Packing / Units<br>Emballage / Unités | 3  | 3  | 3   | 3  |

**PROFESIONAL**



\* Colores especiales disponibles en todos los colores RAL bajo pedido. Consultar Special colours available in all RAL colours under request. Please send us your enquiry. Couleurs spéciales disponibles dans toute gamme de coloris RAL, sur demande.



Soporta 120kg Supports up to 120kg Suporte 120kg



Asa de Seguridad Antiapertura Anti Opening Lock System Poignée de sécurité anti ouverture



Mod. 450-E



400



450



450-E

| MODELO<br>Model / Modèle  | 400  | 450   | 450-E   |
|---|--|---|---|
| CÓDIGO<br>Code / Code   | 162008                                       | 163005  | 164002  |
| MEDIDAS<br>Sizes / Mesures                                      | 400 x 225 x 190 mm<br>15,75 x 8,86 x 7,48 in | 450 x 285 x 250 mm<br>17,72 x 11,22 x 9,84 in   | 450 x 285 x 250 mm<br>17,72 x 11,22 x 9,84 in   |
| CONTIENE<br>Contained / Contient                                | 1 Bandeja<br>Tray / Panier porte-outils      | 1 Bandeja<br>Tray / Panier porte-outils   | 1 Bandeja<br>Tray / Panier porte-outils<br>1 Estuche<br>Organizer / Coffrett  |
| MATERIAL<br>Material / Matériau                                 | PP   | PP<br>Asa Aluminio / Aluminium<br>handle / Poignée Aluminium<br>Cierres metálicos / Metallics<br>locks / Attaches Métalliques | PP<br>Asa Aluminio / Aluminium<br>handle / Poignée Aluminium<br>Cierres metálicos / Metallics<br>locks / Attaches Métalliques |
| COLOR<br>Colour / Couleur                                       | 6  | 3   | 3   |
| EMBALAJE /<br>UNIDADES<br>Packing / Units<br>Emballage / Unités | 6  | 4   | 4   |



# CAJAS DE HERRAMIENTAS DE PLÁSTICO - ALUMINIO

Plastic - aluminium tool boxes / Boîtes à outils plastiques et aluminium

**PROFESIONAL**



\* Colores especiales disponibles en todos los colores RAL bajo pedido. Consultar Special colours available in all RAL colours under request. Please send us your enquiry. Couleurs spéciales disponibles dans toute gamme de coloris RAL, sur demande.



Soporta 120kg  
Supports up to 120kg  
Supporte 120kg



Asa de Seguridad Antiapertura  
Anti Opening Lock System  
Poignée de sécurité anti ouverture



Mod.  
600 - E



Mod.  
500 - E



500



500-E



600



600-E

| MODELO<br>Model / Modèle  | 500   | 500-E   | 600   | 600-E   |
|---|---|---|---|---|
| CÓDIGO<br>Code / Code   | 165009  | 166006  | 167003  | 168000  |
| MEDIDAS<br>Sizes / Mesures                                      | 500 x 295 x 270 mm<br>19,68 x 11,61 x 10,63 in  | 500 x 295 x 270 mm<br>19,68 x 11,61 x 10,63 in  | 600 x 305 x 295 mm<br>23,62 x 12,01 x 11,61 in  | 600 x 305 x 295 mm<br>23,62 x 12,01 x 11,61 in  |
| CONTIENE<br>Contained / Contient                                | 1 Bandeja / Tray<br>Panier porte-outils   | 1 Bandeja / Tray<br>Panier porte-outils<br>1 Estuche<br>Organizer / Coffret   | 1 Bandeja / Tray<br>Panier porte-outils   | 1 Bandeja / Tray<br>Panier porte-outils<br>1 Estuche<br>Organizer / Coffret   |
| MATERIAL<br>Material / Matériau                                 | PP<br>Asa Aluminio<br>Aluminium handle<br>Poignée Aluminium<br>Cierres metálicos<br>Metallics locks<br>Attaches Métalliques | PP<br>Asa Aluminio<br>Aluminium handle<br>Poignée Aluminium<br>Cierres metálicos<br>Metallics locks<br>Attaches Métalliques | PP<br>Asa Aluminio<br>Aluminium handle<br>Poignée Aluminium<br>Cierres metálicos<br>Metallics locks<br>Attaches Métalliques | PP<br>Asa Aluminio<br>Aluminium handle<br>Poignée Aluminium<br>Cierres metálicos<br>Metallics locks<br>Attaches Métalliques |
| EMBALAJE /<br>UNIDADES<br>Packing / Units<br>Emballage / Unités | 3   | 3   | 3   | 3   |

Cierres de seguridad  
Security locks  
Sécurité anti ouverture



Mod.  
550-E

\*Detalle asa de seguridad antiapertura  
Anti opening lock system detail  
Poignée de sécurité anti ouverture de détail



550 - B



550 - E

| MODELO<br>Model / Modèle  | 550 - B   | 550 - E   |
|---|---|---|
| CÓDIGO<br>Code / Code   | 170003  | 171000  |
| MEDIDAS<br>Sizes / Mesures                                      | 550 x 300 x 275 mm<br>21,65 x 11,81 x 10,83 in  | 550 x 300 x 275 mm<br>21,65 x 11,81 x 10,83 in  |
| CONTIENE<br>Contained / Contient                                | 1 Bandeja<br>Tray / Panier porte-outils   | 1 Estuche<br>Organizer / Coffret  |
| MATERIAL<br>Material / Matériau                                 | PP<br>Asa Aluminio / Aluminium handle /<br>Poignée Aluminium<br>Cierres metálicos / Metallics locks /<br>Attaches Métalliques | PP<br>Asa Aluminio / Aluminium handle /<br>Poignée Aluminium<br>Cierres metálicos / Metallics locks /<br>Attaches Métalliques |
| EMBALAJE /<br>UNIDADES<br>Packing / Units<br>Emballage / Unités | 3   | 3   |



\* Colores especiales disponibles en todos los colores RAL bajo pedido. Consultar Special colours available in all RAL colours under request. Please send us your enquiry. Couleurs spéciales disponibles dans toute gamme de coloris RAL, sur demande.



Soporta 120kg  
Supports up to 120kg  
Supporte 120kg



Asa de Seguridad Antiapertura  
Anti Opening Lock System  
Poignée de sécurité anti ouverture



Abierto  
Opened  
Ouvert

Cerrado  
Losed  
Fermé

Cajas de herramientas y estuches  
Tool boxes and organizers  
Boîtes à outils et coffrets

Productos de ordenación  
Arrangement products  
Produits de rangement

Tayg Car  
Tayg Car  
Tayg Car

Colección hogar  
Home collection  
Boîtes de rangement Home

Eco Tayg  
Eco Tayg  
Eco Tayg

Tayg Light  
Tayg Light  
Tayg Light

Tayg Build  
Tayg Build  
Tayg Build

Lista de packing  
Packing list  
Liste d'emballage





## CAJAS DE HERRAMIENTAS DE PLÁSTICO - ALUMINIO

Plastic - aluminium tool boxes | Mobile tool chest

**PROFESIONAL**



\* Colores especiales disponibles en todos los colores RAL bajo pedido. Consultar  
Special colours available in all RAL colours under request. Please send us your enquiry.  
Couleurs spéciales disponibles dans toute gamme de coloris RAL, sur demande.



Soporta 120kg  
Supports up to 120kg  
Supporte 120kg



Asa de Seguridad Antiapertura  
Anti Opening Lock System  
Poignée de sécurité anti ouverture



Mod.  
650 - B



650 - B



650 - E

| MODELO<br>Model / Modèle  | 650 - B  | 650 - E  |
|---|--|--|
| CÓDIGO<br>Code / Code   | 172007   | 173004   |
| MEDIDAS<br>Sizes / Mesures                                      | 650 x 300 x 295 mm<br>25,59 x 11,81 x 11,61 in   | 650 x 300 x 295 mm<br>25,59 x 11,81 x 11,61 in   |
| CONTIENE<br>Contained / Contient                                | 1 Bandeja<br>Tray / Panier porte-outils  | 1 Estuche<br>Organizer / Coffret   |
| MATERIAL<br>Material / Matériau                                 | PP<br>Asa Aluminio / Aluminium<br>handle / Poignée Aluminium<br>Cierres metálicos / Metallic<br>locks / Attaches Métalliques | PP<br>Asa Aluminio / Aluminium<br>handle / Poignée Aluminium<br>Cierres metálicos / Metallic<br>locks / Attaches Métalliques |
| EMBALAJE /<br>UNIDADES<br>Packing / Units<br>Emballage / Unités | 2  | 2  |

## COFRE HERRAMIENTAS MOVIL

Boîtes à outils plastiques et aluminium | Coffre à outils mobile

**PROFESIONAL**



\* Colores especiales disponibles en todos los colores RAL bajo pedido. Consultar  
Special colours available in all RAL colours under request. Please send us your enquiry.  
Couleurs spéciales disponibles dans toute gamme de coloris RAL, sur demande.



Soporta 120kg  
Supports up to 120kg  
Supporte 120kg



Palomillas  
Brackets  
Écrou moleté



Goma eva  
EVA rubber  
EVA gomme

Mod.50

| MODELO<br>Model / Modèle  | 50  | 51   | 53  | 54   |
|---|---|--|---|--|
| CÓDIGO<br>Code / Code   | 150005  | 151002   | 153006  | 154003   |
| MEDIDAS<br>Sizes / Mesures                                      | 675 x 472 x 416 mm<br>26,57 x 18,58 x 16,38 in  | 675 x 472 x 416 mm<br>26,57 x 18,58 x 16,38 in                                 | 775 x 472 x 493 mm<br>30,51 x 18,58 x 19,41 in  | 775 x 472 x 493 mm<br>30,51 x 18,58 x 19,41 in                                 |
| CONTIENE<br>Contained / Contient                                | 2 Bandejas / Tray /<br>Panier porte-outils<br>5 Palomillas<br>Small Bracket / Écrou<br>moleté | 2 Bandejas / Tray /<br>Panier porte-outils<br>2 Estuche<br>Organizer / Coffret | 2 Bandejas / Tray /<br>Panier porte-outils<br>5 Palomillas<br>Small Bracket / Coffret | 2 Bandejas / Tray /<br>Panier porte-outils<br>2 Estuche<br>Organizer / Coffret |
| MATERIAL<br>Material / Matériau                                 | PP  | PP   | PP  | PP   |
| EMBALAJE /<br>UNIDADES<br>Packing / Units<br>Emballage / Unités | 1   | 1  | 1   | 1  |



# TRAIL BOX / SAFETY TOOL BOX

Trail box / Safety tool box  
Servanter de chantier / Safety tool box





## TRAIL BOX

Trail box / Servanter de chantier



\* Colores especiales disponibles en todos los colores RAL bajo pedido. Consultar  
Special colours available in all RAL colours under request. Please send us your enquiry.  
Couleurs spéciales disponibles dans toute gamme de coloris RAL, sur demande.



Soporta 120kg  
Supports up to 120kg  
Supporte 120kg



Goma eva  
EVA rubber  
EVA gomme



| MODELO<br>Model / Modèle  | 57   | 58  |
|---|--|---|
| CÓDIGO<br>Code / Code   | 157004   | 158001  |
| MEDIDAS<br>Sizes / Mesures                                      | 470 x 290 x 630 mm<br>18,50 x 11,42 x 24,80 in | 470 x 290 x 630 mm<br>18,50 x 11,42 x 24,80 in                              |
| CONTIENE<br>Contained / Contient                                | 1 Bandeja<br>Tray / Panier porte-outils        | 1 Bandeja<br>Tray / Panier porte-outils<br>1 Estuches/ Organizer / Coffrett |
| MATERIAL<br>Material / Matériau                                 | PP   | PP<br>Cierres metálicos<br>Metallic locks / Attaches Métalliques            |
| EMBALAJE /<br>UNIDADES<br>Packing / Units<br>Emballage / Unités | 1  | 1   |

## SAFETY TOOL BOX

Safety tool box / Safety tool box

**PROFESIONAL**



Soporta 120kg  
Supports up to 120kg  
Supporte 120kg



Cierres y asa luminiscente  
Luminiscent lock and handle  
Poignée et fermails luminescents



Diseñado para la seguridad  
Safety design  
Conçu pour la sécurité



| MODELO<br>Model / Modèle  | Estuche<br>46-26 STB                       | Maleta 40 STB     | Caja 34 STB                               | Cofre 54 STB                              | Pack STB   |
|---|--|-------------------|---|---|--|
| CÓDIGO<br>Code / Code   | 146800                                     | 140808            | 134807                                    | 154805                                    | 154980   |
| MEDIDAS<br>Sizes / Mesures                                      | 378 x 290 x 61mm                           | 385 x 330 x 130mm | 580 x 285 x 290mm                         | 775 x 472 x 493mm                         | 775 x 472 x 493mm  |
| CONTIENE<br>Contained<br>Contient                               | 21 Separadores<br>Dividers/<br>Séparateurs | -                 | 1 Bandeja / Tray /<br>Panier porte-outils | 2 Bandeja / Tray /<br>Panier porte-outils | 1 cofre, 1 maleta, 1<br>caja y 1 estuche<br>1 chest, 1 Cases, 1<br>tool box, 1 Organizer<br>1 coffre, 1 Mallette,<br>1 boîte, 1 Coffrett |
| EMBALAJE /<br>UNIDADES<br>Packing / Units<br>Emballage / Unités | 6  | 7                 | 3   | 1   | 1  |



## TRAIL BOX PRO

Trail box pro / Servanter de chantier pro



\* Colores especiales disponibles en todos los colores RAL bajo pedido. Consultar Special colours available in all RAL colours under request. Please send us your enquiry. Couleurs spéciales disponibles dans toute gamme de coloris RAL, sur demande.



Soporta 120kg  
Supports up to 120kg  
Supporte 120kg



Mod. 59

## PROFESIONAL



Cierre de seguridad: levantar y girar para abrir  
Security lock: pull up and turn to open  
Fermeture de sécurité: lever et tourner pour ouvrir



## PROFESIONAL



\* Colores especiales disponibles en todos los colores RAL bajo pedido. Consultar Special colours available in all RAL colours under request. Please send us your enquiry. Couleurs spéciales disponibles dans toute gamme de coloris RAL, sur demande.



Soporta 120kg  
Supports up to 120kg  
Supporte 120kg



\*Disponibles accesorios de venta por separado  
Available Accessories sold separately  
Accessoires disponibles a la vente séparément



**MODELO**  
Model / Modèle

59

**CÓDIGO**  
Code / Code

159008

**MEDIDAS**  
Sizes / Mesures

500 x 410 x 770 mm  
19,68 x 16,14 x 30,31 in

**CONTIENE**  
Contained / Contient

1 Estuche 430/50/25 / Organizer / Coffret  
1 Estuche 430/80/13 / Organizer / Coffret  
1 Estuche 430/80/0 / Organizer / Coffret  
1 Maleta 44B / Bag / Mallette  
1 Maleta Cajón  
Drawer suitcase / Mallette tiroir

**MATERIAL**  
Material / Matériau

PP  
Cajones y tapa transparente-PS  
Drawers and transparent cover-PS  
Tiroirs et couvercles transparents-PS

**EMBALAJE / UNIDADES**  
Packing / Units  
Emballage / Unités

1



# CAJA DE HERRAMIENTAS COLECCIÓN BÁSICA

Basic line tool boxes / Boîtes à outils Basic Line



\* Colores especiales disponibles en todos los colores RAL bajo pedido. Consultar Special colours available in all RAL colours under request. Please send us your enquiry. Couleurs spéciales disponibles dans toute gamme de coloris RAL, sur demande.

Mod.  
Multibox n1

AccessoryBox 01



AccessoryBox 02



AccessoryBox 03



Multibox n1 BL

| MODELO<br>Model / Modèle  | AccessoryBox 01                          | AccessoryBox 02                          | AccessoryBox 03                          | Multibox n1 BL   |
|---|--|--|--|--|
| CÓDIGO<br>Code / Code   | 022555                                   | 023552                                   | 024559                                   | 301551   |
| MEDIDAS<br>Sizes / Mesures                                      | 312 x 238 x 51 mm                        | 388 x 290 x 61 mm                        | 460 x 350 x 81 mm                        | 335 x 250 x 275 mm   |
| CONTIENE<br>Contained / Contient                                | 21 Separadores<br>Dividers / Séparateurs | 21 Separadores<br>Dividers / Séparateurs | 21 Separadores<br>Dividers / Séparateurs | Módulo +<br>4 estuches 22 + asa<br>Piece +<br>4 organizers 22 + handle<br>Module +<br>4 coffret 22 + poignée |
| MATERIAL<br>Material / Matériau                                 | PP                                       | PP                                       | PP                                       | PP   |
| EMBALAJE /<br>UNIDADES<br>Packing / Units<br>Emballage / Unités | 6  | 6  | 5  | 2  |



\* Colores especiales disponibles en todos los colores RAL bajo pedido. Consultar Special colours available in all RAL colours under request. Please send us your enquiry. Couleurs spéciales disponibles dans toute gamme de coloris RAL, sur demande.



Soporta 120kg  
Supports up to 120kg  
Supporte 120kg

Mod.  
ToolBox 16"

ToolBox 12"



ToolBox 16"



ToolBox 20"

| MODELO<br>Model / Modèle  | ToolBox 12"                             | ToolBox 16"                             | ToolBox 20"                             |
|---|---|---|---|
| CÓDIGO<br>Code / Code   | 110559                                  | 112553                                  | 115554                                  |
| MEDIDAS<br>Sizes / Mesures                                      | 290 x 170 x 127 mm                      | 400 x 217 x 166 mm                      | 500 x 258 x 255 mm                      |
| CONTIENE<br>Contained / Contient                                | 1 Bandeja<br>Tray / Panier porte-outils | 1 Bandeja<br>Tray / Panier porte-outils | 1 Bandeja<br>Tray / Panier porte-outils |
| MATERIAL<br>Material / Matériau                                 | PP                                      | PP                                      | PP                                      |
| EMBALAJE /<br>UNIDADES<br>Packing / Units<br>Emballage / Unités | 10                                      | 6                                       | 3                                       |



# BOLSAS, MOCHILAS, CINTURONES Y TROLLEYS

Bags, backpacks, belts and trolleys  
Sacs, sacs à dos, ceintures et sac à dos à roulette





## BOLSAS HERRAMIENTAS

Tool bags / Sacs à outils



Con 4 tacos de apoyo en el fondo  
With 4 rubber feet  
Avec 4 taquets d'appui dans le fond

Mod. BN-1 (13")

Mod. BN-7 (20")

Mod. BN-3 (18")

**NOVEDAD**  
NEW / NOUVEAUTÉ

**NOVEDAD**  
NEW / NOUVEAUTÉ

| MODELO<br>Model / Modèle                                     | Bolsa Herramientas BN-1 (13")<br>Tool Bag BN-1(13")<br>Sacs à outils BN-1(13") | Bolsa Herramientas BN-3 (18")<br>Tool Bag BN-3(18")<br>Sacs à outils BN-3(18")  | Bolsa Herramientas BN-7 (20")<br>Tool Bag BN-7 (20")<br>Sacs à outils BN-7 (20") |
|--|--|---|--|
| CÓDIGO<br>Code / Code  | 080005   | 082009  | 097003   |
| MEDIDAS<br>Sizes / Mesures                                   | 345 x 220 x 225 mm   | 455 x 250 x 265 mm  | 500 x 220 x 290 mm   |
| MATERIAL<br>Material / Matériau                              | Poliéster 600D<br>Polyester 600D<br>Polyester 600D                             | Bolsa Poliéster 600D<br>Fondo Polietileno<br>Polyester 600D Bag<br>Base Polytene<br>Polyester 600D Sac<br>Fond Polyéthylène | Poliéster 600D<br>Polyester 600D<br>Polyester 600D                               |
| EMBALAJE / UNIDADES<br>Packing / Units<br>Emballage / Unités | 6 U - 6 pcs.   | 6 U - 6 pcs.  | 6 U - 6 pcs.   |

## CINTURÓN HERRAMIENTAS

Tool belt / Ceintures outils

**PROFESIONAL**



Mod.

Cinturón herramientas doble-profesional  
Professional double tool pouch  
Ceinture porte-outils double professionnelle



Mod.

Cinturón herramientas doble  
Double tool pouch  
Ceinture porte-outils double

| MODELO<br>Model / Modèle                                     | Cinturón herramientas simple<br>Simple tool pouch<br>Ceinture porte-outils simple | Cinturón herramientas doble<br>Double tool pouch<br>Ceinture porte-outils double | Cinturón herramientas simple-profesional<br>Professional simple tool pouch<br>Ceinture porte-outils simple professionnelle | Cinturón herramientas doble-profesional<br>Professional double tool pouch<br>Ceinture porte-outils double professionnelle |
|--|---|--|--|---|
| CÓDIGO<br>Code / Code  | 089602  | 090608   | 091605   | 092602  |
| MATERIAL<br>Material / Matériau                              | Poliéster 600D<br>Polyester 600D<br>Polyester 600D                                | Poliéster 600D<br>Polyester 600D<br>Polyester 600D                               | Poliéster 600D<br>Polyester 600D<br>Polyester 600D   | Poliéster 600D<br>Polyester 600D<br>Polyester 600D  |
| EMBALAJE / UNIDADES<br>Packing / Units<br>Emballage / Unités | 10 U - 10 pcs.  | 6 U - 6 pcs.   | 10 U - 10 pcs.   | 6 U - 6 pcs.  |

Cajas de herramientas y estuches  
Tool boxes and organizers  
Boîtes à outils et coffrets

Productos de ordenación  
Arrangement products  
Produits de rangement

Tayg Car  
Tayg Car  
Tayg Car

Colección hogar  
Home collection  
Boîtes de rangement Home

Eco Tayg  
Eco Tayg  
Eco Tayg

Tayg Light  
Tayg Light  
Tayg Light

Tayg Build  
Tayg Build  
Tayg Build

Lista de packing  
Packing list  
Liste d'emballage



# MOCHILA HERRAMIENTAS

Backpack / Sacs à dos à outils



Ligero  
Lightweight  
Légère



Impermeable  
Waterproof  
Imperméable

**XL**

Tamaño 33L  
Size 33L  
Taille XL 33L

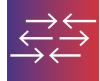

Resistente  
Resistant  
Résistante



Puerto de salida USB  
USB port  
Port de sortie USB



Amplios compartimentos exteriores  
Wide external compartments  
Amplis compartiments extérieurs



Mod.

Bolsa herramientas Roll tool / Roll tool bag / Rouleau à outils

Mod.  
Bucket bag



Mod. BP20



Base reforzada, resistente a productos químicos y agua  
Reinforced base, resistant to chemicals and water.  
Base renforcée, résistante aux produits chimiques et à l'eau



Mod. TR20



Ligero  
Lightweight  
Légère



Impermeable  
Waterproof  
Imperméable

**XL**

Tamaño 33L  
Size 33L  
Taille XL 33L

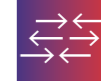

Resistente  
Resistant  
Résistante

| MODELO<br>Model / Modèle                                     | BP20                                    | Bolsa Herramientas roll tool<br>Roll tool Bag<br>Rouleau à outils | Bucket bag   |
|--|---|---|--|
| CÓDIGO<br>Code / Code  | 097614                                  | 099601  | 099618   |
| MEDIDAS<br>Sizes / Mesures                                   | 390 x 190 x 490 mm                      | 380 x 500 x 5 mm  | 450 x 300 mm - Ø300mm                              |
| CAPACIDAD<br>Capacity / Capacité                             | 33 Ltrs                                 | -   | -  |
| MATERIAL<br>Material / Matériau                              | Poliéster 600D<br>Polyester / Polyester | Poliéster 600D<br>Polyester 600D<br>Polyester 600D                | Poliéster 600D<br>Polyester 600D<br>Polyester 600D |
| EMBALAJE / UNIDADES<br>Packing / Units<br>Emballage / Unités | 2                                       | 40 U  | 6 U  |

| MODELO<br>Model / Modèle                                     | TR20  |
|--|---|
| CÓDIGO<br>Code / Code  | 098611  |
| MEDIDAS<br>Sizes / Mesures                                   | 380 x 210 x 520 mm  |
| CAPACIDAD<br>Capacity / Capacité                             | 33 Ltrs   |
| MATERIAL<br>Material / Matériau                              | Poliéster 1200D y ruedas en PU<br>Polyester 1200D and wheels in PU<br>Polyester 1200D et roues PU |
| EMBALAJE / UNIDADES<br>Packing / Units<br>Emballage / Unités | 1   |



Compartimento interior extraíble  
Internal removable compartment  
Compartiment intérieur amovible



Asa telescópica  
Telescopic handle  
Manche télescopique





# CINTURONES Y SOPORTES DE CUERO

Leather belts and holders / Ceintures et supports à cuir

MADE IN SPAIN



\* Con trabilla para colgar.  
With belt loop to hang.  
Avec boucles de ceinture à accrocher.

Mod.

Soporte electricista  
Electrician holder  
Support electricien



Mod.

Soporte cutter  
Cutter holder  
Support cutter



Mod.

Soporte martillo  
Hammer holder  
Support marteau

\* Con trabilla para colgar.  
With belt loop to hang.  
Avec boucles de ceinture à accrocher.



Mod.

Guarda tijeras podar  
Pruning shears holder  
Support sécateurs

\* Con trabilla para colgar.  
With belt loop to hang.  
Avec boucles de ceinture à accrocher.



MODELO  
Model / Modèle

Soporte electricista  
Electrician holder  
Support electricien

Guarda tijeras podar  
Pruning shears holder  
Support sécateurs

Soporte cutter  
Cutter holder  
Support cutter

Soporte martillo  
Hammer holder  
Support marteau

CÓDIGO  
Code / Code

083600

084607

082603

081606

MATERIAL  
Material / Matériau

Cuero natural  
Natural leather  
Cuir naturel

Cuero natural  
Natural leather  
Cuir naturel

Cuero natural  
Natural leather  
Cuir naturel

Cuero natural  
Natural leather  
Cuir naturel

EMBALAJE /  
UNIDADES  
Packing / Units  
Emballage / Unités

10

10

10

10

# PROFESIONAL

MADE IN SPAIN

Cinturón ajustable  
Adjustable belt  
Ceinture ajustable



5 compartimentos  
5 compartments  
5 compartiments

Mod.

Cinturón soporte simple  
Simple hold belt  
Ceinture support simple

Soporte para martillo  
Hammer holder  
Support pour marteau

Cinturón ajustable  
Adjustable belt  
Ceinture ajustable



11 compartimentos  
11 compartments  
11 compartiments

Mod.

Cinturón soporte profesional  
Professional hold belt  
Ceinture support Professionnel

Soporte para martillo  
Hammer holder  
Support pour marteau

MODELO  
Model / Modèle

Cinturón soporte simple  
Simple hold belt  
Ceinture support simple

Cinturón soporte profesional  
Professional hold belt  
Ceinture support professionnel

CÓDIGO  
Code / Code

086601

087608

MATERIAL  
Material / Matériau

Cuero natural  
Natural leather / Cuir naturel

Cuero natural  
Natural leather / Cuir naturel

EMBALAJE /  
UNIDADES  
Packing / Units  
Emballage / Unités

10

10

# PRODUCTOS DE ORDENACIÓN

Arrangement products | Produits de rangement  
Produkten für Aufbewahrung



## GAVETAS APILABLES 50

Stackable drawers  
Bac à bec empilable  
Stapelsichtboxen



## GAVETA PLEGABLE APILABLE 52

Stackable folding drawer  
Bac à bec pliable empilable  
Faltbare Stapelsichtboxen



## TABLA DE RESISTENCIA A LA COMPRESIÓN | KIT DE COLGAR 54

Compression strength table | Hanging kit  
Tableau de résistance à la compression |  
Kit a accrocher  
Druckfestigkeitstabelle | Kit zum Aufhängen



## EURO-CAJAS PARA ALMACÉN Y TRANSPORTE | EURO-CAJAS CON TAPA PARA ALMACÉN Y TRANSPORTE 56

Multi purpose Heavy Duty Boxes | Multi  
purpose Heavy Duty Boxes with cover  
Bacs emboîtables pour stockage et  
transport | Conteneurs avec couvercle pour  
le stockage et le transport  
Euroboxen für Lagerung und Transport |  
Euroboxen mit Deckel für Lagerung und  
Transport



## ESTANTERÍAS. MÓDULO CAIRO 58

Shelves. Cairo model  
Étagère. Cairo modèle  
Regale. Cairo Modul



## KIT ESTANTERÍA METÁLICA | CAJONES ESTANTERÍAS 60

Metal shelves kit | Drawers for shelves  
Set étagères métalliques | Tiroirs étagères  
Kit für Metallregal | Schubladen für Regale



## KIT ESTANTERÍA METÁLICA CON CAJONES | CONTENEDORES BASCULANTES 62

Boxes with mobile dividers |  
Cabinet with tilttable drawers  
Set étagère métallique avec tiroirs |  
Bacs basculants  
Kit für Metallregal und Schubladen |  
Kippbare Behälter



## ESTANTERÍAS METÁLICAS | KIT ESTANTERÍA METÁLICA 64

Metal shelves | Metal shelves kit  
Étagères métalliques | Set étagères métalliques  
Für Metallregal | Kit für Metallregal



## KIT ESTANTERÍA PLÁSTICO 66

Plastic shelves kit  
Set étagère plastique  
Kit für Kunststoffregal



## MÓDULOS METÁLICOS | CONTENEDORES CAJONES 68

Metal stackable modules |  
Cabinet with drawers  
Modules métalliques | Casiers à tiroirs  
Stapelbare Metallmodule |  
Behälter mit Schubladen



## CLASIFICADORES APILABLES | MÓDULOS APILABLES 70

Stackable classifiers unit | Stackable modules  
Racks de rangement apilables |  
Modules empilables  
Stapelbare Sortierregale | Stapelbare Module



## MULTIBOX 72

Multibox  
Multibox  
Multibox



# GAVETAS APILABLES

Stackable drawers / Bac à bec empilable



\* Colores especiales disponibles en todos los colores RAL bajo pedido. Consultar Special colours available in all RAL colours under request. Please send us your enquiry. Couleurs spéciales disponibles dans toute gamme de coloris RAL, sur demande.



Apto para uso alimentario. Registro sanitario nº 3904321/V Food Graded. Health registration nº 3904321/V Apte pour l'utilisation alimentaire. Registre sanitaire nº 3904321/V



| MODELO<br>Model / Modèle  | 56                               | 58                               | 59                               | 60                               |
|---|----------------------------------|----------------------------------|----------------------------------|----------------------------------|
| <b>CÓDIGO</b><br>Code / Code  | ● 256028<br>● 256103<br>○ 256349 | ● 258022<br>● 258107<br>○ 258343 | ● 259029<br>● 259104<br>○ 259340 | ● 260025<br>● 260100<br>○ 260346 |
| <b>MEDIDAS</b><br>Sizes / Mesures                                   | 420 x 270 x 175 mm               | 500 x 303 x 200 mm               | 500 x 303 x 300 mm               | 600 x 400 x 300 mm               |
| <b>CAPACIDAD (LITROS)</b><br>Capacity (Litres)<br>Capacité (Litres) | 13.9                             | 22.2                             | 34                               | 51.3                             |
| <b>MATERIAL</b><br>Material / Matériau                              | PP                               | PP                               | PP                               | PP                               |
| <b>EMBALAJE / UNIDADES</b><br>Packing / Units<br>Emballage / Unités | 8                                | 12                               | 6                                | 6                                |

**Etiquetas descargables en la web**  
Downloadable labels on the web / Étiquettes téléchargeables sur le web

**Etiquetas descargables en la web**  
Downloadable labels on the web / Étiquettes téléchargeables sur le web



\* Colores especiales disponibles en todos los colores RAL bajo pedido. Consultar Special colours available in all RAL colours under request. Please send us your enquiry. Couleurs spéciales disponibles dans toute gamme de coloris RAL, sur demande.



Uso industrial  
Industrial use  
Usage industriel



| MODELO<br>Model / Modèle  | 56                   | 58                   | 59                   | 60                   |
|---|----------------------|----------------------|----------------------|----------------------|
| <b>CÓDIGO</b><br>Code / Code  | ● 256066<br>● 256110 | ● 258060<br>● 258114 | ● 259067<br>● 259111 | ● 260063<br>● 260117 |
| <b>MEDIDAS</b><br>Sizes / Mesures                                   | 420 x 270 x 175 mm   | 500 x 303 x 200 mm   | 500 x 303 x 300 mm   | 600 x 400 x 300 mm   |
| <b>CAPACIDAD (LITROS)</b><br>Capacity (Litres)<br>Capacité (Litres) | 13.9                 | 22.2                 | 34                   | 51.3                 |
| <b>MATERIAL</b><br>Material / Matériau                              | PP                   | PP                   | PP                   | PP                   |
| <b>EMBALAJE / UNIDADES</b><br>Packing / Units<br>Emballage / Unités | 8                    | 12                   | 6                    | 6                    |

\*Gaveta Ref. 260063 modelo compatible con euroroller. Drawer Ref. 260063, model compatible with euroroller / Tiroir Ref. 260063 modèle compatible avec euroroller



| MODELO<br>Model / Modèle  | 51                               | 52                               | 53                               | 54                               | 55                               |
|---|----------------------------------|----------------------------------|----------------------------------|----------------------------------|----------------------------------|
| <b>CÓDIGO</b><br>Code / Code  | ● 251023<br>● 251108<br>○ 251344 | ● 252020<br>● 252105<br>○ 252341 | ● 253027<br>● 253102<br>○ 253348 | ● 254024<br>● 254109<br>○ 254345 | ● 255021<br>● 255106<br>○ 255342 |
| <b>MEDIDAS</b><br>Sizes / Mesures                                   | 170 x 100 x 80 mm                | 236 x 160 x 130 mm               | 336 x 160 x 130 mm               | 336 x 216 x 155 mm               | 336 x 216 x 200 mm               |
| <b>CAPACIDAD (LITROS)</b><br>Capacity (Litres)<br>Capacité (Litres) | 0.8                              | 3.2                              | 4.8                              | 7.7                              | 10.1                             |
| <b>MATERIAL</b><br>Material / Matériau                              | PP                               | PP                               | PP                               | PP                               | PP                               |
| <b>EMBALAJE / UNIDADES</b><br>Packing / Units<br>Emballage / Unités | 24                               | 15                               | 10                               | 12                               | 8                                |



| MODELO<br>Model / Modèle  | 51                   | 52                   | 53                   | 54                   | 55                   |
|---|----------------------|----------------------|----------------------|----------------------|----------------------|
| <b>CÓDIGO</b><br>Code / Code  | ● 251061<br>● 251115 | ● 252068<br>● 252112 | ● 253065<br>● 253119 | ● 254062<br>● 254116 | ● 255069<br>● 255113 |
| <b>MEDIDAS</b><br>Sizes / Mesures                                   | 170 x 100 x 80 mm    | 236 x 160 x 130 mm   | 336 x 160 x 130 mm   | 336 x 216 x 155 mm   | 336 x 216 x 200 mm   |
| <b>CAPACIDAD (LITROS)</b><br>Capacity (Litres)<br>Capacité (Litres) | 0.8                  | 3.2                  | 4.8                  | 7.7                  | 10.1                 |
| <b>MATERIAL</b><br>Material / Matériau                              | PP                   | PP                   | PP                   | PP                   | PP                   |
| <b>EMBALAJE / UNIDADES</b><br>Packing / Units<br>Emballage / Unités | 24                   | 15                   | 10                   | 12                   | 8                    |

Cajas de herramientas y estuches  
Tool boxes and organizers  
Boîtes à outils et coffrets

Productos de ordenación  
Arrangement products  
Produits de rangement

Tayg Car  
Tayg Car  
Tayg Car

Colección hogar  
Home collection  
Boîtes de rangement Home

Eco Tayg  
Eco Tayg  
Eco Tayg

Tayg Light  
Tayg Light  
Tayg Light

Tayg Build  
Tayg Build  
Tayg Build

Lista de packing  
Packing list  
Liste d'emballage



# GAVETA PLEGABLE APILABLE

Stackable folding drawer / Bac à bec pliable empilable



\* Colores especiales disponibles en todos los colores RAL bajo pedido. Consultar Special colours available in all RAL colours under request. Please send us your enquiry. Couleurs spéciales disponibles dans toute gamme de coloris RAL, sur demande.



Apto para uso alimentario. Registro sanitario nº 3904321/V Food Graded. Health registration nº 3904321/V Apte pour l'utilisation alimentaire. Registre sanitaire nº 3904321/V



Eficiencia logística Logistic efficiency Efficacité logistique



Fácil transporte  
Easy and optimized  
Transport facile



| MODELO<br>Model / Modèle  | 54P                  | 56P                  | 59P                  | 60P                  |
|---|----------------------|----------------------|----------------------|----------------------|
| CÓDIGO<br>Code / Code   | ● 204029<br>⊖ 204340 | ● 206023<br>⊖ 206344 | ● 209024<br>⊖ 209345 | ● 210020<br>⊖ 210341 |
| MEDIDAS<br>Sizes / Mesures                                      | 336 x 216 x 175 mm   | 420 x 270 x 200 mm   | 500 x 303 x 275 mm   | 600 x 400 x 325 mm   |
| CAPACIDAD<br>(LITROS)<br>Capacity (Litres)<br>Capacité (Litres) | 8,5                  | 15                   | 30                   | 55                   |
| MATERIAL<br>Material / Matériau                                 | PP                   | PP                   | PP                   | PP                   |
| EMBALAJE /<br>UNIDADES<br>Packing / Units<br>Emballage / Unités | 11                   | 11                   | 8                    | 6                    |



**Etiquetas descargables en la web**  
Downloadable labels on the web / Étiquettes téléchargeables sur le web



**Etiquetas descargables en la web**  
Downloadable labels on the web / Étiquettes téléchargeables sur le web



**TOP VENTAS**  
BEST SELLER  
TOP VENTES

Fácil transporte  
Easy and optimized  
Transport facile

\*Gaveta Ref. 52 y Ref. 52P son apilable y compatibles con gaveta regulable Gaveta Ref. 53 y Ref. 53P son apilable y compatibles con gaveta regulable Drawer Ref. 52 and Ref. 52P stackable and compatible with regular bins Drawer Ref. 53 and Ref. 53P stackable and compatible with regular bins Tiroir Ref.52 et Ref.52P sont apilables et compatibles avec tiroir réglable Tiroir Ref.53 et Ref.53P sont apilables et compatibles avec tiroir réglable



Información resistencia técnica en la página 54  
Technical resistance information on the page 54  
Information de la résistance technique à la page 54



\* Colores especiales disponibles en todos los colores RAL bajo pedido. Consultar Special colours available in all RAL colours under request. Please send us your enquiry. Couleurs spéciales disponibles dans toute gamme de coloris RAL, sur demande.



Apto para uso alimentario. Registro sanitario nº 3904321/V Food Graded. Health registration nº 3904321/V Apte pour l'utilisation alimentaire. Registre sanitaire nº 3904321/V



Eficiencia logística Logistic efficiency Efficacité logistique



| MODELO<br>Model / Modèle  | 52P   | 53P   |
|---|---|---|
| CÓDIGO<br>Code / Code   | ● 202025<br>⊖ 202346  | ● 203022<br>⊖ 203343  |
| MEDIDAS<br>Sizes / Mesures                                      | 236 x 160 x 130 mm  | 336 x 160 x 130 mm  |
| CONTIENE<br>Contained / Contient                                | 1 Kit = 5 Gavetas flejadas<br>1 Kit = 5 Strapped bin boxes<br>1 Set= 5 Bacs à bec dépliés | 1 Kit = 5 Gavetas flejadas<br>1 Kit = 5 Strapped bin boxes<br>1 Set= 5 Bacs à bec dépliés |
| MATERIAL<br>Material / Matériau                                 | PP  | PP  |
| EMBALAJE /<br>UNIDADES<br>Packing / Units<br>Emballage / Unités | 8 Kits = 40 U   | 8 Kits = 40 U   |

Cajas de herramientas y estuches  
Tool boxes and organizers  
Boîtes à outils et coffrets

Productos de ordenación  
Arrangement products  
Produits de rangement

Tayg Car  
Tayg Car  
Tayg Car

Colección hogar  
Home collection  
Boîtes de rangement Home

Eco Tayg  
Eco Tayg  
Eco Tayg

Tayg Light  
Tayg Light  
Tayg Light

Tayg Build  
Tayg Build  
Tayg Build

Lista de packing  
Packing list  
Liste d'emballage



# TABLA RESISTENCIA A LA COMPRESIÓN

Compression strength table / Tableau de résistance à la compression

## PRODUCTOS PÁGINA 50 / Page 50 products / Produits page 50

| GAVETA APILABLE<br>Stackable drawer<br>Bac à bec empilable |                     | ENSAYO A COMPRESIÓN<br>(HASTA LÍMITE DE DEFLEXIÓN 3 mm)<br>Compression test<br>(up to deflection limit of 3 mm)<br>Test de compression<br>(jusqu'à la flèche maximale 3mm) |  | ENSAYO A COMPRESIÓN<br>(HASTA DEFLEXIÓN MÁXIMA)<br>Compression test<br>(up to maximum deflection limit)<br>Test de compression<br>(jusqu'à la déviation maximale) |  | ENSAYO A COMPRESIÓN<br>(CON 6 GAVETAS APILADAS)<br>Compression test<br>(with 6 stackable drawers)<br>Test de compression<br>(avec 6 bac à bec empilés) |  |
|--|---------------------|--|--|---|--|--|--|
|  |                     | (kg) Resistencia<br>Strenght / Résistance  | (mm) Deformación<br>Deformation<br>Déformation | (kg) Resistencia<br>Strenght / Résistance   | (mm) Deformación<br>Deformation<br>Déformation | (kg) Resistencia<br>Strenght / Résistance  | (mm) Deformación<br>Deformation<br>Déformation |
|  |                     | <b>251023</b>  | <b>GAVETA 51 az</b>                            | 506   | 2.4  | 506  | 2.4  |
| <b>252020</b>  | <b>GAVETA 52 az</b> | 1172   | 3  | 1172  | 3.5  | 549  | 16.1   |
| <b>253027</b>  | <b>GAVETA 53 az</b> | 1179   | 3  | 1163  | 3  | 506  | 21.7   |
| <b>254024</b>  | <b>GAVETA 54 az</b> | 1247   | 3  | 1233  | 3  | 545  | 25.2   |
| <b>255021</b>  | <b>GAVETA 55 az</b> | 1116   | 3  | 1446  | 5.5  | 570  | 45.9   |
| <b>258022</b>  | <b>GAVETA 58 az</b> | 1163   | 3  | 1982  | 6.8  | 833  | 57.7   |
| <b>259029</b>  | <b>GAVETA 59 az</b> | 797  | 3  | 1487  | 5  | 643  | 32.7   |
| <b>260025</b>  | <b>GAVETA 60 az</b> | 1694   | 3  | 2833  | 6.5  | 1356   | 48.3   |

## PRODUCTOS PÁGINA 52 / Page 52 products / Produits page 52

| GAVETA PLEGABLE<br>Y APILABLE. CONDICIÓN: A<br>40°C. Foldable and stackable<br>drawer conditions: to 40°C<br>Bac à bec pliable et empilable<br>condition : A 40°C |                         | ENSAYO A COMPRESIÓN<br>(HASTA LÍMITE DE DEFLEXIÓN 3 mm)<br>Compression test<br>(up to deflection limit of 3 mm)<br>Test de compression<br>(jusqu'à la flèche maximale 3mm) |  | ENSAYO A COMPRESIÓN<br>(HASTA DEFLEXIÓN MÁXIMA)<br>Compression test<br>(up to maximum deflection limit)<br>Test de compression<br>(jusqu'à la déviation maximale) |  | ENSAYO A COMPRESIÓN<br>(CON 6 GAVETAS APILADAS)<br>Compression test<br>(with 6 stackable drawers)<br>Test de compression<br>(avec 6 bac à bec empilés) |  |
|---|-------------------------|--|--|---|--|--|--|
|   |                         | (kg) Resistencia<br>Strenght<br>Résistance   | (mm) Deformación<br>Deformation<br>Déformation | (kg) Resistencia<br>Strenght<br>Résistance  | (mm) Deformación<br>Deformation<br>Déformation | (kg) Resistencia<br>Strenght<br>Résistance   | (mm) Deformación<br>Deformation<br>Déformation |
|   |                         | <b>204029</b>  | <b>GAVETA 54P az</b>                           | 355   | 3  | 382  | 3.7  |
| <b>204340</b>   | <b>GAVETA 54P trans</b> | 311  | 3  | 340   | 4.0  | 288  | 23.6   |
| <b>206023</b>   | <b>GAVETA 56P az</b>    | 422  | 3  | 457   | 3.8  | 405  | 22.9   |
| <b>206344</b>   | <b>GAVETA 56P trans</b> | 361  | 3  | 398   | 4.0  | 348  | 23.2   |
| <b>209024</b>   | <b>GAVETA 59P az</b>    | 616  | 3  | 655   | 4.2  | 469  | 19.5   |
| <b>209345</b>   | <b>GAVETA 59P trans</b> | 482  | 3  | 548   | 4.6  | 382  | 20.9   |
| <b>210020</b>   | <b>GAVETA 60P az</b>    | 530  | 3  | 605   | 4.9  | 432  | 19.7   |
| <b>210341</b>   | <b>GAVETA 60P trans</b> | 434  | 3  | 524   | 5.2  | 382  | 17.7   |

| GAVETA PLEGABLE<br>Y APILABLE. CONDICIÓN: A<br>-18°C. Foldable and stackable<br>drawer conditions: to -18°C<br>Bac à bec pliable et empilable<br>condition : A -18°C |                         | ENSAYO A COMPRESIÓN<br>(HASTA LÍMITE DE DEFLEXIÓN 3 mm)<br>Compression test<br>(up to deflection limit of 3 mm)<br>Test de compression<br>(jusqu'à la flèche maximale 3mm) |  | ENSAYO A COMPRESIÓN<br>(HASTA DEFLEXIÓN MÁXIMA)<br>Compression test<br>(up to maximum deflection limit)<br>Test de compression<br>(jusqu'à la déviation maximale) |  | ENSAYO A COMPRESIÓN<br>(CON 6 GAVETAS APILADAS)<br>Compression test<br>(with 6 stackable drawers)<br>Test de compression<br>(avec 6 bac à bec empilés) |  |
|--|-------------------------|--|--|---|--|--|--|
|  |                         | (kg) Resistencia<br>Strenght<br>Résistance   | (mm) Deformación<br>Deformation<br>Déformation | (kg) Resistencia<br>Strenght<br>Résistance  | (mm) Deformación<br>Deformation<br>Déformation | (kg) Resistencia<br>Strenght<br>Résistance   | (mm) Deformación<br>Deformation<br>Déformation |
|  |                         | <b>204029</b>  | <b>GAVETA 54P az</b>                           | 701   | 3  | 722  | 3.6  |
| <b>204340</b>  | <b>GAVETA 54P trans</b> | 701  | 3  | 725   | 3.7  | 540  | 18   |
| <b>206023</b>  | <b>GAVETA 56P az</b>    | 897  | 3  | 956   | 3.6  | 599  | 10.5   |
| <b>206344</b>  | <b>GAVETA 56P trans</b> | 889  | 3  | 948   | 3.6  | 545  | 13.0   |
| <b>209024</b>  | <b>GAVETA 59P az</b>    | 1253   | 3  | 1269  | 3.4  | 989  | 19.2   |
| <b>209345</b>  | <b>GAVETA 59P trans</b> | 1204   | 3  | 1246  | 3.8  | 953  | 22.4   |
| <b>210020</b>  | <b>GAVETA 60P az</b>    | 1199   | 3  | 1286  | 4.1  | 939  | 20.2   |
| <b>210341</b>  | <b>GAVETA 60P trans</b> | 1067   | 3  | 1164  | 4.3  | 756  | 19.8   |

\*Tabla correspondiente a valores típicos, según informe de ensayo AT-0042/02 de AIMPLAS, realizado en los laboratorios del Departamento de logística, embalaje y transporte de mercancías de AIDIMA (Parque Tecnológico-Paterna). / Table corresponding to typical values, according to the AIMPLAS AT-0042/02 test, performed in laboratories of the AIDIMA Merchandise Logistics, Packaging and Shipping Department (Technology Park-Paterna). / Tableau correspondant aux valeurs typiques, selon rapport de situation AIMPLAS AT-0042/02 de AIDIMA, réalisé dans les laboratoires du département de logistique, emballage et transport de marchandises



5040  
Contenedor apilable encajable  
Stackable cabinet  
Bac empilable emboitable

Mod.

Mod.

Kit Colgar G-51  
Hanging kit G-51  
Kit a accrocher G-51

| MODELO<br>Model / Modèle  | MODELO<br>Model / Modèle   | MODELO<br>Model / Modèle   |
|---|--|--|
| 5040 Contenedor apilable encajable<br>Stackable cabinet<br>Bac empilable emboitable | Kit Colgar G-50<br>Hanging kit G-50<br>Kit a accrocher G-50          | Kit Colgar G-51<br>Hanging kit G-51<br>Kit a accrocher G-51                      |
| <b>CÓDIGO</b><br>Code / Code  | <b>250903</b>  | <b>251900</b>  |
| <b>MEDIDAS</b><br>Sizes / Mesures   | 91 x 520 x 53 mm   | 170 x 520 x 80 mm  |
| <b>CONTIENE</b><br>Contained<br>Contient  | 5 Gavetas / 1 Colgador<br>5 Drawers / 1 Hanger<br>5 Bacs / 1 Rail    | 5 Gavetas n°51 / 1 Colgador<br>5 Drawers n°51 / 1 Hanger<br>5 Bacs n°51 / 1 Rail |
| <b>CAPACIDAD</b><br>(LITROS)<br>Capacity (Litres)<br>Capacité (Litres)              | 50   |  |
| <b>MATERIAL</b><br>Material / Matériau  | Gaveta PP / Colgador PS<br>Drawer PP / Hanger PS<br>Bac PP / Rail PS | Gaveta PP / Colgador PS<br>Drawer PP / Hanger PS<br>Bac PP / Rail PS             |
| <b>EMBALAJE / UNIDADES</b><br>Packing / Units<br>Emballage / Unités                 | 7  | 10   |

Cajas de herramientas y estuches  
Tool boxes and organizers  
Boîtes à outils et coffrets

Productos de ordenación  
Arrangement products  
Produits de rangement

Tayg Car  
Tayg Car  
Tayg Car

Colección hogar  
Home collection  
Boîtes de rangement Home

Eco Tayg  
Eco Tayg  
Eco Tayg

Tayg Light  
Tayg Light  
Tayg Light

Tayg Build  
Tayg Build  
Tayg Build

Lista de packing  
Packing list  
Liste d'emballage



## EURO-CAJAS PARA ALMACÉN Y TRANSPORTE

Multi purpose Heavy Duty Boxes / Bacs emboîtables pour stockage et transport



\* Colores especiales disponibles en todos los colores RAL bajo pedido. Consultar  
Special colours available in all RAL colours under request. Please send us your enquiry.  
Couleurs spéciales disponibles dans toute gamme de coloris RAL, sur demande.



Apto para uso alimentario.  
Registro sanitario nº 3904321/V  
Food Graded.Health registration nº 3904321/V  
Apte pour l'utilisation alimentaire.  
Registre sanitaire nº 3904321/V



Personalizable con tecnología IML  
Customizable with IML technology  
Personnalisable avec la technologie IML



Tecnología de RFID  
RFID technology  
Technologie RFID



| MODELO<br>Model / Modèle                                     | 6415   | 6420   | 6430   | 6440   | 6400   |
|--|--|--|--|--|--|
| CÓDIGO<br>Code / Code  | ● 261008<br>○ 261299   | ● 262005<br>○ 262296   | ● 263002<br>○ 263293   | ● 264009<br>○ 264290   | ● 299001<br>○ 299292                                 |
| MEDIDAS<br>Sizes / Mesures                                   | 600 x 400 x 150 mm   | 600 x 400 x 200 mm   | 600 x 400 x 300 mm   | 600 x 400 x 400 mm   | 600 x 405 x 29 mm                                    |
| CAPACIDAD (LITROS)<br>Capacity (Litres)<br>Capacité (Litres) | 22 L.  | 34 L.  | 51 L.  | 69 L.  | -  |
| PESO (KG.)<br>Weight / Poids                                 | 1,23 Kg.   | 1,62 Kg.   | 2,16 Kg.   | 2,74 Kg.   | 0,65 Kg.   |
| MATERIAL<br>Material / Matériau                              | PP   | PP   | PP   | PP   | PP   |
| EMBALAJE / UNIDADES<br>Packing / Units<br>Emballage / Unités | 6 Retráctil / 92 Palet<br>6 Retractable / 92 Pallet<br>6 paquet d'emballage / 92 Palette | 6 Retráctil / 64 Palet<br>6 Retractable / 64 Pallet<br>6 paquet d'emballage / 64 Palette | 6 Retráctil / 48 Palet<br>6 Retractable / 48 Pallet<br>6 paquet d'emballage / 48 Palette | 6 Retráctil / 32 Palet<br>6 Retractable / 32 Pallet<br>6 paquet d'emballage / 32 Palette | 6 Retráctil<br>6 Retractable<br>6 paquet d'emballage |

## EURO-CAJAS CON TAPA PARA ALMACÉN Y TRANSPORTE

Multi purpose Heavy Duty Boxes with cover / Conteneurs avec couvercle pour le stockage et le transport



\* Colores especiales disponibles en todos los colores RAL bajo pedido. Consultar  
Special colours available in all RAL colours under request. Please send us your enquiry.  
Couleurs spéciales disponibles dans toute gamme de coloris RAL, sur demande.



Apto para uso alimentario.  
Registro sanitario nº 3904321/V  
Food Graded.Health registration nº 3904321/V  
Apte pour l'utilisation alimentaire.  
Registre sanitaire nº 3904321/V



Personalizable con tecnología IML  
Customizable with IML technology  
Personnalisable avec la technologie IML



Tecnología de RFID  
RFID technology  
Technologie RFID



Uso industrial  
Industrial use  
Usage industriel



| MODELO<br>Model / Modèle                                     | 6424-T   | 6434-T   | 6444-T   | Euroroller  |
|--|--|--|--|---|
| CÓDIGO<br>Code / Code  | ● 265006   | ● 266003<br>● 266065   | ● 267000<br>● 267062   | 267994  |
| MEDIDAS<br>Sizes / Mesures                                   | 600 x 400 x 240 mm   | 600 x 400 x 340 mm   | 600 x 400 x 440 mm   | 615 x 415 x 49mm  |
| CAPACIDAD (LITROS)<br>Capacity (Litres)<br>Capacité (Litres) | 39 L.  | 58 L.  | 75 L.  | 250 Kg  |
| PESO (KG.)<br>Weight / Poids                                 | 2,5 kg   | 3 kg   | 3,7 kg   | 3,9 kg  |
| MATERIAL<br>Material / Matériau                              | PP   | PP   | PP   | PP reforzado<br>PP reinforced<br>PP renforcé                                |
| EMBALAJE / UNIDADES<br>Packing / Units<br>Emballage / Unités | 6 Retráctil / 56 Palet<br>6 Retractable / 56 Pallet<br>6 paquet d'emballage / 56 Palette | 6 Retráctil / 48 Palet<br>6 Retractable / 48 Pallet<br>6 paquet d'emballage / 48 Palette | 6 Retráctil / 32 Palet<br>6 Retractable / 32 Pallet<br>6 paquet d'emballage / 32 Palette | 5 UDS /<br>Ruedas desmontadas /<br>Disassembled wheels /<br>Roues démontées |

Productos de ordenación  
Arrangement products  
Produits de rangement  
  
 Tayg Car  
Tayg Car  
Tayg Car  
  
 Colección hogar  
Home collection  
Boîtes de rangement Home  
  
 Eco Tayg  
Eco Tayg  
Eco Tayg  
  
 Tayg Light  
Tayg Light  
Tayg Light  
  
 Tayg Build  
Tayg Build  
Tayg Build  
  
 Lista de packing  
Packing list  
Liste d'emballage



# ESTANTERÍAS. MÓDULO CAIRO

Shelves. Cairo model / Étagère. Cairo modèle



Mod.

Modelo doble con ruedas  
Double model with wheels  
Modèle double avec roues



Mod.

Modelo simple con ruedas  
Simple model with wheels  
Modèle simple avec roues



Mod.

Modelo serie A  
Serie A model  
Série Modèle A



Mod.

Modelo serie B  
Serie B model  
Série Modèle B



Mod.

Modelo simple sin ruedas  
Simple model without wheels  
Modèle simple sans roues

\* Ideal para anclaje en la pared.  
Ideal for wall anchoring.  
Idéal pour l'ancrage au mur.



**Modelo doble con ruedas (10 alturas, 2 caras)**  
**Double model with wheels (10 heights, 2 faces)**  
**Modèle double avec roues (10 hauteurs, 2 faces)**



**Modelo simple con ruedas (7 alturas, 2 caras)**  
**Simple model with wheels (7 heights, 2 faces)**  
**Modèle simple avec roues (7 hauteurs, 2 faces)**



**Modelo serie A (10 alturas, 1 cara) sin ruedas**  
**Serie A model (10 heights, 1 face) without wheels**  
**Série Modèle A (10 hauteurs, 1 face) sans roues**



**Modelo serie B (10 alturas, 1 cara) sin ruedas**  
**Serie B model (10 heights, 1 face) without wheels**  
**Série Modèle B (10 hauteurs, 1 face) sans roues**



**Modelo simple sin ruedas (7 alturas, 1 cara)**  
**Simple model without wheels (7 heights, 1 face)**  
**Modèle simple sans roues (7 hauteurs, 1 côté)**

| MODELO<br>Model / Modèle                 | 396007  | 396045  |
|--|---|---|
| <b>CÓDIGO</b><br>Code / Code             | 396007  | 396045  |
| <b>MEDIDAS</b><br>Sizes / Mesures        | 900 x 640 x 1800mm  | 900 x 640 x 1305mm  |
| <b>CONTIENE</b><br>Contained<br>Contient | 9 líneas de 8 gavetas 51 = 72 gavetas = 3 cajas de 24<br>9 líneas de 5 gavetas 52 = 45 gavetas = 3 cajas de 15<br>2 líneas de 4 gavetas 55 = 8 gavetas = 1 caja de 10 (sobran 2)<br>9 lines 8 drawers 51 = 72 drawers = 3 boxes of 24<br>9 lines 5 drawers 52 = 45 drawers = 3 boxes of 15<br>2 lines 4 drawers 55 = 8 drawers = 1 boite en 10 (left 2)<br>9 lignes 8 bac 51 = 72 bac = 3 boites en 24<br>9 lignes 5 bac 52 = 45 bac = 3 boites en 15<br>2 lignes 4 bac 55 = 8 bac = 1 boite en 10 (restants 2) | 6 líneas de 8 gavetas 51 = 48 gavetas = 2 cajas de 24<br>6 líneas de 5 gavetas 52 = 30 gavetas = 2 cajas de 15<br>2 líneas de 4 gavetas 55 = 8 gavetas = 1 caja de 8<br>6 lines 8 drawers 51 = 48 drawers = 2 boxes of 24<br>6 lines 5 drawers 52 = 30 drawers = 2 boxes of 15<br>2 lines 4 drawers 55 = 8 drawers = 1 boite en 8<br>6 lignes 8 bac 51 = 48 bac = 2 boites en 24<br>6 lignes 5 bac 52 = 30 bac = 2 boites en 15<br>2 lignes 4 bac 55 = 8 bac = 1 boite en 8 |

| MODELO<br>Model<br>Modèle                | 396021   | 396014   | 396038  |
|--|--|--|---|
| <b>CÓDIGO</b><br>Code / Code             | 396021   | 396014   | 396038  |
| <b>MEDIDAS</b><br>Sizes<br>Mesures       | 900 x 400 x 1965mm   | 900 x 400 x 1695mm   | 900 x 400 x 1200mm  |
| <b>CONTIENE</b><br>Contained<br>Contient | 6 líneas de 8 gavetas 51 = 48 gavetas = 2 cajas de 24<br>3 líneas de 5 gavetas 52 = 15 gavetas = 1 caja de 15<br>1 línea de 4 gavetas 55 = 4 gavetas = 1 caja de 8 (sobran 4)<br>6 lines 8 drawers 51 = 48 drawers = 2 box of 24<br>3 lines 5 drawers 52 = 15 drawers = 1 box of 15<br>1 lines 4 drawers 55 = 4 drawers = 1 boite en 8 (left 4)<br>6 lignes 8 bac 51 = 48 bac = 2 boites en 24<br>3 lignes 5 bac 52 = 15 bac = 1 boites en 15<br>1 lignes 4 bac 55 = 4 bac = 1 boite en 8 (restants 4) | 3 líneas de 8 gavetas 51 = 24 gavetas = 1 caja de 24<br>6 líneas de 5 gavetas 52 = 30 gavetas = 2 cajas de 15<br>1 línea de 4 gavetas 55 = 4 gavetas = 1 caja de 8 (sobran 4)<br>3 lines 8 drawers 51 = 24 drawers = 1 box of 24<br>6 lines 5 drawers 52 = 30 drawers = 2 boxes of 15<br>1 lines 4 drawers 55 = 4 drawers = 1 boite en 8 (left 4)<br>3 lignes 8 bac 51 = 24 bac = 1 boites en 24<br>6 lignes 5 bac 52 = 30 bac = 2 boites en 15<br>1 lignes 4 bac 55 = 4 bac = 1 boite en 8 (restants 4) | 3 líneas de 8 gavetas 51 = 24 gavetas = 1 caja de 24<br>3 líneas de 5 gavetas 52 = 15 gavetas = 1 caja de 15<br>1 línea de 4 gavetas 55 = 4 gavetas = 1 caja de 8 (sobran 4)<br>3 lines 8 drawers 51 = 24 drawers = 1 box of 24<br>3 lines 5 drawers 52 = 15 drawers = 1 box of 15<br>1 lines 4 drawers 55 = 4 drawers = 1 boite en 8 (left 4)<br>3 lignes 8 bac 51 = 24 bac = 1 boites en 24<br>3 lignes 5 bac 52 = 15 bac = 1 boites en 15<br>1 lignes 4 bac 55 = 4 bac = 1 boite en 8 (restants 4) |

Cajas de herramientas y estuches  
Tool boxes and organizers  
Boîtes à outils et coffrets

Productos de ordenación  
Arrangement products  
Produits de rangement

Tayg Car  
Tayg Car  
Tayg Car

Colección hogar  
Home collection  
Boîtes de rangement Home

Eco Tayg  
Eco Tayg  
Eco Tayg

Tayg Light  
Tayg Light  
Tayg light

Tayg Build  
Tayg Build  
Tayg Build

Lista de packing  
Packing list  
Liste d'emballage



## KIT ESTANTERÍA METÁLICA

Metal shelves kit / Set étagères métalliques



| MODELO<br>Model / Modèle          | 300   | 400   |
|-----------------------------------|---|---|
| CÓDIGO<br>Code / Code             | 398001  | 399008  |
| MEDIDAS<br>Sizes / Mesures        | 1030 x 337 x 2050 mm  | 1030 x 437 x 2050 mm  |
| CONTIENE<br>Contained<br>Contient | 4 Puntales / 16 Bandejas 300 /<br>Acc. 16 Bandejas 300<br>4 Studs<br>16 Trays 300 / Acc. 16 Trays 300<br>4 Montants<br>16 Rayons 300 / Acc. 16 rayons 300 | 4 Puntales / 16 Bandejas 400 /<br>Acc. 16 Bandejas 400<br>4 Studs<br>16 Trays 400 / Acc. 16 Trays 400<br>4 Montants<br>16 Rayons 400 / Acc. 16 rayons 400 |

MODELO  
Model / Modèle

**Kit estantería 301  
Shelving kit 301  
Set étagères 301**

**Kit estantería 401  
Shelving kit 401  
Set étagères 401**

| CÓDIGO<br>Code / Code | 398308 | 399305 |
|-----------------------|--------|--------|
|-----------------------|--------|--------|

| MEDIDAS<br>Sizes / Mesures | 1030 x 337 x 2050 mm | 1030 x 437 x 2050 mm |
|----------------------------|----------------------|----------------------|
|----------------------------|----------------------|----------------------|

| CONTIENE<br>Contained<br>Contient | 1 Estantería 300 (16 Bandejas)<br>120 Cajones 301<br>18 bolsas de 20 Separadores 01<br>1 Shelving 300 (16 Trays) / 120 Drawers<br>301 / 18 bags of 20 dividers 01<br>1 étagères 300 (16 Rayons) / 120<br>Tiroirs 301 / 18 sacs 20 séparateurs 01 | 1 Estantería 400 (16 Bandejas)<br>120 Cajones 401<br>30 bolsas de 20 Separadores 01<br>1 Shelving 400 (16 Trays) / 120 Drawers<br>401 / 30 bags of 20 dividers 01<br>1 étagères 400 (16 Rayons) / 120<br>Tiroirs 401 / 30 sacs 20 séparateurs 01 |
|-----------------------------------|--|--|
|-----------------------------------|--|--|



MODELO  
Model / Modèle

**Kit estantería 302  
Shelving kit 302  
Set étagères 302**

**Kit estantería 402  
Shelving kit 402  
Set étagères 402**

| CÓDIGO<br>Code / Code | 398315 | 399312 |
|-----------------------|--------|--------|
|-----------------------|--------|--------|

| MEDIDAS<br>Sizes / Mesures | 1030 x 337 x 2050 mm | 1030 x 437 x 2050 mm |
|----------------------------|----------------------|----------------------|
|----------------------------|----------------------|----------------------|

| CONTIENE<br>Contained<br>Contient | 1 estantería 300 (16 Bandejas) /<br>60 Cajones 302 / 18 bolsas de 10<br>Separadores 02<br>1 Shelving 300 (16 Trays) / 60 Drawers<br>302 / 18 bags of 10 dividers 02<br>1 étagères 300 (16 Rayons) / 60 Tiroirs<br>302 / 18 sacs 10 séparateurs 02 | 1 estantería 400 (16 Bandejas) /<br>60 Cajones 402 / 30 bolsas de 10<br>Separadores 02<br>1 Shelving 400 (16 Trays) / 60 Drawers<br>402 / 30 bags of 10 dividers 02<br>1 étagères 400 (16 Rayons) / 60 Tiroirs<br>402 / 30 sacs 10 séparateurs 02 |
|-----------------------------------|---|---|
|-----------------------------------|---|---|

## CAJONES ESTANTERÍAS

Drawers for shelves / Tiroirs étagères

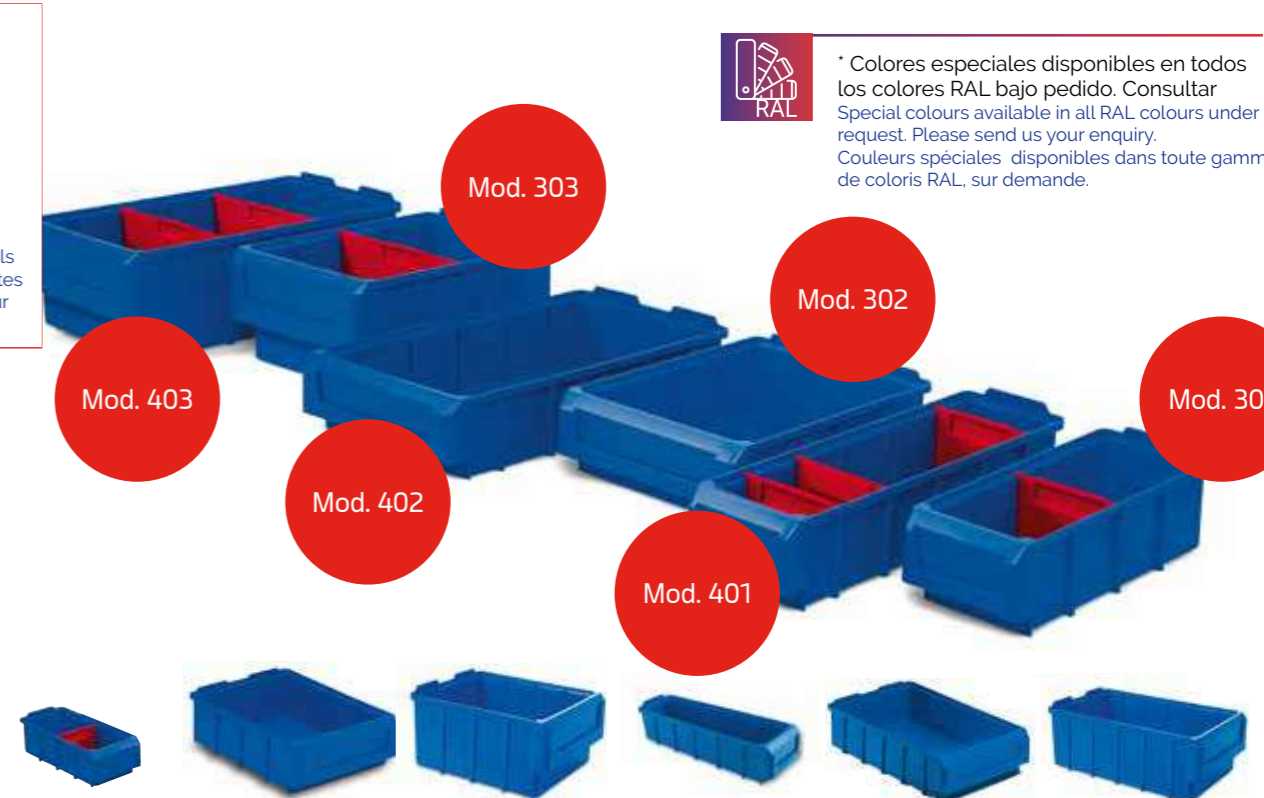

\* Colores especiales disponibles en todos los colores RAL bajo pedido. Consultar Special colours available in all RAL colours under request. Please send us your enquiry. Couleurs spéciales disponibles dans toute gamme de coloris RAL, sur demande.

| MODELO<br>Model / Modèle | 301 | 302 | 303 | 401 | 402 | 403 |
|--------------------------|-----|-----|-----|-----|-----|-----|
|--------------------------|-----|-----|-----|-----|-----|-----|

| CÓDIGO<br>Code / Code | 355004 | 356001 | 357008 | 360008 | 361005 | 362002 |
|-----------------------|--------|--------|--------|--------|--------|--------|
|-----------------------|--------|--------|--------|--------|--------|--------|

| MEDIDAS<br>Sizes / Mesures | 291 x 116 x 90 mm | 291 x 232 x 90 mm | 291 x 232 x 140 mm | 391 x 116 x 90 mm | 391 x 232 x 90 mm | 391 x 232 x 140 mm |
|----------------------------|-------------------|-------------------|--------------------|-------------------|-------------------|--------------------|
|----------------------------|-------------------|-------------------|--------------------|-------------------|-------------------|--------------------|

| CAPACIDAD (LITROS)<br>Capacity (Litres)<br>Capacité (Litres) | 2 L. | 4.4 L. | 7 L. | 2.7 L. | 6.1 L. | 9.7 L. |
|--|------|--------|------|--------|--------|--------|
|--|------|--------|------|--------|--------|--------|

| MATERIAL<br>Material / Matériau | Cajones PP<br>Drawers PP<br>Tiroirs PP | Cajones PP<br>Drawers PP<br>Tiroirs PP | Cajones PP<br>Drawers PP<br>Tiroirs PP | Cajones PP<br>Drawers PP<br>Tiroirs PP | Cajones PP<br>Drawers PP<br>Tiroirs PP | Cajones PP<br>Drawers PP<br>Tiroirs PP |
|---------------------------------|--|--|--|--|--|--|
|---------------------------------|--|--|--|--|--|--|

| EMBALAJE / UNIDADES<br>Packing / Units<br>Emballage / Unités | 20 | 10 | 8 | 20 | 10 | 8 |
|--|----|----|---|----|----|---|
|--|----|----|---|----|----|---|

MODELO  
Model / Modèle



| CÓDIGO<br>Code / Code | 390005 | 391002 | 392009 |
|-----------------------|--------|--------|--------|
|-----------------------|--------|--------|--------|

| MEDIDAS<br>Sizes / Mesures | 103x79 mm | 219x79 mm | 219x129 mm |
|----------------------------|-----------|-----------|------------|
|----------------------------|-----------|-----------|------------|

| MATERIAL<br>Material / Matériau | PP | PP | PP |
|---------------------------------|----|----|----|
|---------------------------------|----|----|----|

| UDS. BOLSA<br>Units bag / Unités sac | 20 | 10 | 10 |
|--------------------------------------|----|----|----|
|--------------------------------------|----|----|----|

**SEPARADORES  
Dividers / Séparateurs**







## KIT ESTANTERÍA METÁLICA CON CAJONES

Boxes with mobile dividers / Set étagère métallique avec tiroirs



Mod.

Kit estantería 303  
Shelving kit 303  
Set étagères 303



Mod.

Kit estantería 310  
Shelving kit 310  
Set étagères 310

| MODELO<br>Model / Modèle   | Kit estantería 303<br>Shelving kit 303<br>Set étagères 303 | Kit estantería 403<br>Shelving kit 403<br>Set étagères 403 | Kit estantería 310<br>Shelving kit 310<br>Set étagères 310 | Kit estantería 410<br>Shelving kit 410<br>Set étagères 410 |
|----------------------------|--|--|--|--|
| CÓDIGO<br>Code / Code      | 398322   | 399329   | 398339   | 399336   |
| MEDIDAS<br>Sizes / Mesures | 1030 x 337 x 2050 mm                                       | 1030 x 437 x 2050 mm                                       | 1030 x 337 x 2050 mm                                       | 1030 x 437 x 2050 mm                                       |

### CONTIENE Contained Contient

1 Estantería 300 (12 Bandejas) / 48 Cajones 303 / 13 Bolsas de 10 / Separadores 03  
1 Shelving 300 (12 Trays) / 48 Drawers 303 / 13 Bags of 10 dividers 03  
1 Étagères 300 (12 Rayons) / 48 Tiroirs 303 / 13 Sacs 10 Séparateurs 03

1 estantería 400 (12 Bandejas) / 48 Cajones 403 / 15 bolsas de 10 / Separadores 03  
1 Shelving 400 (12 Trays) / 48 Drawers 403 / 15 bags of 10 dividers 03  
1 Étagères 400 (12 Rayons) / 48 Tiroirs 403 / 15 Sacs 10 Séparateurs 03

1 estantería 300 / (15 Bandejas) / 40 Cajones 301 / 20 Cajones 302 / 16 Cajones 303 / 6 bolsas de 20 Separadores 01 / 6 bolsas de 10 Separadores 02 / 4 bolsas de 10 / Separadores 03  
1 shelving 300 / (15Trays) / 40 Drawers 301 / 20 Drawers 302 / 16 Drawes 303 / 6 bags of 20 dividers 01 / 6 bags of 10 dividers 02 / 4 bags of 10 dividers 03  
1 Étagères 300 (15 Rayons) / 40 Tiroirs 301/ 20 Tiroirs 302 / 16 Tiroirs 303 / 6 Sacs 20 Séparateurs 01 / 6 Sacs 10 Séparateurs 02 / 4 Sacs 10 / Séparateurs 03

1 estantería 400 / (15 Bandejas) / 40 Cajones 401 / 20 Cajones 402 / 16 Cajones 403 / 10 bolsas de 20 Separadores 01 / 10 bolsas de 10 Separadores 02 / 8 bolsas de 10 Separadores 03  
40 Drawers 401 / 20 Drawers 402 / 16 Drawes 403 / 10 bags of 20 dividers 01 / 10 bags of 10 dividers 02 / 8 bags of 10 dividers 03  
1 Étagères 400 (15 Rayons) / 40 Tiroirs 401/ 20 Tiroirs 402 / 16 Tiroirs 403 / 10 Sacs 20 Séparateurs 01 / 10 Sacs 10 Séparateurs 02 / 8 Sacs 10 / Séparateurs 03

## CONTENEDORES BASCULANTES

Cabinet with tiltable drawers / Bacs basculants

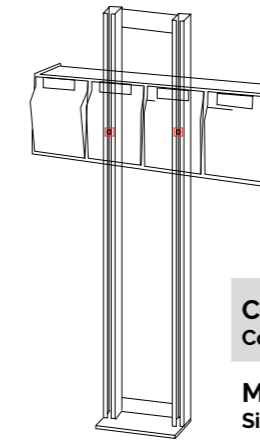

Apto para uso alimentario.  
Registro sanitario nº 3904321/V  
Food Graded. Health registration nº 3904321/V  
Apte pour l'utilisation alimentaire.  
Registre sanitaire nº 3904321/V

### SOPORTE / Support / Supports

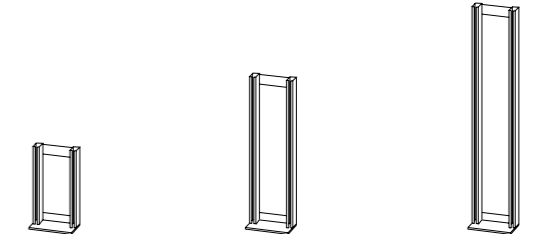

| CÓDIGO<br>Code / Code      | 340000 | 341007 | 342004 |
|----------------------------|--------|--------|--------|
| MEDIDAS<br>Sizes / Mesures | 60 cm  | 121 cm | 177 cm |

### VARILLA CIERRE / Closing rod / Tige étroite



MODELO  
Model / Modèle

Varilla cierre  
Closing rod  
Tige étroite

10 tornillos y arandelas  
10 screws and washers  
10 vis et rondelles

| CÓDIGO<br>Code / Code | 343001 | 344008 |
|-----------------------|--------|--------|
|-----------------------|--------|--------|



| CÓDIGO<br>Code / Code  | 333606  | 334603  | 335600  | 336607  | 339608  |
|--|---|---|---|---|---|
| CAJONES<br>Drawers / Tiroirs                                       | 3   | 4   | 5   | 6   | 9   |
| MEDIDAS<br>Sizes / Mesures   | 600 x 196 x 241 mm  | 600 x 168 x 206 mm  | 600 x 133 x 165 mm  | 600 x 92 x 114 mm   | 600 x 63 x 81 mm  |
| MATERIAL<br>Material<br>Matériau                                   | PS  | PS  | PS  | PS  | PS  |
| CONTIENE<br>Contained<br>Contient                                  | No contiene tornillos<br>Ne contient pas de vis<br>Doesn't contain screws | No contiene tornillos<br>Ne contient pas de vis<br>Doesn't contain screws | No contiene tornillos<br>Ne contient pas de vis<br>Doesn't contain screws | No contiene tornillos<br>Ne contient pas de vis<br>Doesn't contain screws | No contiene tornillos<br>Ne contient pas de vis<br>Doesn't contain screws |
| EMBALAJE /<br>UNIDADES<br>Packing / Units<br>Emballage /<br>Unités | 4   | 6   | 6   | 12  | 12  |



## ESTANTERÍAS METÁLICAS

Metal shelves / Étagères métalliques



Soporta 150kg por estante  
Up to 150 kg per shelf  
Jusqu'à 150 kg par étagère



Montaje en 10 minutos  
Assembly in 10 minutes  
Assemblée en 10 minutes



Mod.  
397011



Mod.  
397028



MODELO  
Model / Modèle

Estanteria 906 (6 niv)  
Shelving 906 (6 lvl)  
Étagères 906 (6 niv)

Estanteria 1205 (5 niv)  
Shelving 1205 (5 lvl)  
Étagères 1205 (5 niv)

Estanteria 1206 (6 niv)  
Shelving 1206 (6 lvl)  
Étagères 1206 (6 niv)

CÓDIGO  
Code / Code

397011

397028

397035

MEDIDAS  
Sizes / Mesures

900 x 450 x 2000 mm

1200 x 450 x 2000 mm

1200 x 450 x 2000 mm

CONTIENE  
Contained  
Contient

4 Puntales, 12 Largueros VT,  
12 Largueros VLTAM,  
6 Tableros aglomerados 16 mm,  
4 Pies de plástico  
4 Studs, 12 Transversal brackets VT, 12  
Longitudinal bracket VLTAM, 6 Trays 16  
mm, 4 Plastic bottoms  
4 Jambes de force, 12 BarresVT,  
12 Barres VLTAM,  
6 Etagères en aglomeré  
16mm et 4 pieds en plastique

4 Puntales, 10 Largueros VT,  
10 Largueros VLTAM,  
5 Tableros aglomerados 16 mm,  
4 Pies de plástico  
4 Studs, 10 Transversal brackets VT, 10  
Longitudinal bracket VLTAM, 5 Trays 16  
mm, 4 Plastic bottoms  
4 Jambes de force, 10 barresVT,  
10 Barres VLTAM, 5 Etagères  
en aglomeré  
16mm et 4 pieds en plastique

4 Puntales, 12 Largueros VT,  
12 Largueros VLTAM,  
6 Tableros aglomerados 16 mm,  
4 Pies de plástico  
4 Studs, 12 Transversal brackets VT, 12  
Longitudinal bracket VLTAM, 6 Trays 16  
mm, 4 Plastic bottoms  
4 Jambes de force, 12 BarresVT,  
12 Barres VLTAM,  
6 Etagères en aglomeré  
16mm et 4 pieds en plastique

## KIT ESTANTERÍA METÁLICA

Metal shelves kit / Set étagères métalliques



Soporta 150kg por estante  
Up to 150 kg per shelf  
Jusqu'à 150 kg par étagère



Montaje en 10 minutos  
Assembly in 10 minutes  
Assemblée en 10 minutes



Mod.

Kit estanteria 906 C  
Shelving kit 906 C  
Set étagères 906 C



Mod.

Kit estanteria 1205 C  
Shelving kit 1205 C  
Set étagères 1205 C



MODELO  
Model / Modèle

Kit estanteria 906 C  
Shelving kit 906 C  
Set étagères 906 C

Kit estanteria 1205 C  
Shelving kit 1205 C  
Set étagères 1205 C

Kit estanteria 1206 C  
Shelving kit 1206 C  
Set étagères 1206 C

CÓDIGO  
Code / Code

397042

397059

397066

MEDIDAS  
Sizes / Mesures

900 x 450 x 2000 mm

1200 x 450 x 2000 mm

1200 x 450 x 2000 mm

CONTIENE  
Contained  
Contient

4 Puntales, 12 Largueros VT,  
12 Largueros VLTAM,  
6 Tableros aglomerados 16 mm, 4 Pies de  
plástico, 24 gavetas nº 56, 3 Cajas  
4 Studs, 12 Transversal brackets VT,  
12 Longitudinal  
bracket VLTAM, 6 Trays 16 mm,  
4 Plastic bottoms,  
24 Drawers nº 56, 3 Boxes  
4 Jambes de force, 12 BarresVT,  
12 Barres VLTAM,  
6 Etagères en aglomeré 16mm et 4 pieds  
en plastique, 24 Bacs nº 56, 3 Boites

4 Puntales, 10 Largueros VT, 10 Largueros  
VLTAM,  
5 Tableros aglomerados 16 mm, 4 Pies de  
plástico, 24 gavetas nº 56, 4 Cajas  
4 Studs, 10 Transversal brackets VT, 10  
Longitudinal bracket VLTAM, 5 Trays 16  
mm, 4 Plastic bottoms,  
24 Drawers nº 56, 4 Boxes  
4 Jambes de force, 10 barresVT, 10 Barres  
VLTAM, 5 Etagères en aglomeré 16mm  
et 4 pieds en plastique, 24 Bacs nº 56, 4  
Boites

4 Puntales, 12 Largueros VT,  
12 Largueros VLTAM,  
6 Tableros aglomerados 16 mm, 4 Pies de  
plástico, 32 gavetas nº 56, 4 Cajas  
4 Studs, 12 Transversal brackets VT,  
12 Longitudinal  
bracket VLTAM, 6 Trays 16 mm, 4 Plastic  
bottoms, 32 Drawers nº 56, 4 Boxes  
4 Jambes de force, 12 BarresVT,  
12 Barres VLTAM, 6 Etagères en aglomeré  
16mm et 4 pieds en plastique,  
32 Bacs nº 56, 4 Boites



# KIT ESTANTERÍA PLÁSTICO

Plastic shelves kit / Set étagère plastique



\* Colores especiales disponibles en todos los colores RAL bajo pedido. Consultar Special colours available in all RAL colours under request. Please send us your enquiry. Couleurs spéciales disponibles dans toute gamme de coloris RAL, sur demande.

Estanteria regulable  
Adjustable shelves  
Étagères réglables



Mod. 744



Mod. 634



Mod. 635



634



635



744



745

| MODELO<br>Model / Modèle                        | 634   | 635   | 744   | 745   |
|---|---|---|---|---|
| CÓDIGO<br>Code / Code                           | 228001  | 227004  | 226007  | 225000  |
| MEDIDAS<br>Sizes / Mesures                      | 600 x 300 x 1370 mm   | 600 x 300 x 1800 mm   | 700 x 400 x 1366 mm   | 700 x 400 x 1800 mm   |
| KG PORESTANTE<br>Kg per shelf<br>Kg par étagère | 30 Kg   | 30 Kg   | 40 Kg   | 40 Kg   |
| CONTIENE<br>Contained<br>Contient               | 4 Bandejas, 12 Puntales, 4 Tapones, 4 Pies, 2 Soportes estanteria<br>4 Trays, 12 Studs, 4 Caps, 4 Feet, 2 Shelving supports<br>4 Rayons, 12 Montants, 4 Bouchons, 4 Pieds, 2 Supports étagère | 5 Bandejas, 16 Puntales, 4 Tapones, 4 Pies, 2 Soportes estanteria<br>5 Trays, 16 Studs, 4 Caps, 4 Feet, 2 Shelving supports<br>5 Rayons, 16 Montants, 4 Bouchons, 4 Pieds, 2 Supports étagère | 4 Bandejas, 12 Puntales, 16 Casquillos reguladores, 4 Tapones, 4 Pies, 2 Soportes estanteria<br>4 Trays, 12 Studs, 16 Regulating bushings, 4 Caps, 4 Feet, 2 Shelving supports<br>4 Rayons, 12 Montants, 16 Renforts de niveau, 4 Bouchons, 4 Pieds, 2 Supports étagère | 5 Bandejas, 16 Puntales, 20 Casquillos reguladores, 6 Tapones, 6 Pies, 3 Soportes estanteria<br>5 Trays, 16 Studs, 20 Regulating bushings, 6 Caps, 6 Feet, 3 Shelving supports<br>5 Rayons, 16 Montants, 20 Renforts de niveau, 6 Bouchons, 6 Pieds, 3 Supports étagère |
| MATERIAL<br>Material / Matériau                 | Resina PP<br>PP Resin / PP résine   | Resina PP<br>PP Resin / PP résine   | Resina PP<br>PP Resin / PP résine   | Resina PP<br>PP Resin / PP résine   |

| EMBALAJE / UNIDADES<br>Packing / Units<br>Emballage / Unités | 1 | 1 | 1 | 1 |
|--|---|---|---|---|
|--|---|---|---|---|



Mod. 945



Mod. 944

Estanteria regulable  
Adjustable shelves  
Étagères réglables

| MODELO<br>Model / Modèle                        | 944   | 945   | 944 HD  | 945 HD  |
|---|---|---|---|---|
| CÓDIGO<br>Code / Code                           | ● 221002<br>● 221064<br>○ 221170  | ● 220005<br>● 220067<br>○ 220173  | ● 221446<br>● 221453  | ● 220449<br>● 220456  |
| MEDIDAS<br>Sizes / Mesures                      | 900 x 400 x 1370 mm   | 900 x 400 x 1800 mm   | 900 x 400 x 1370 mm   | 900 x 400 x 1800 mm   |
| KG PORESTANTE<br>Kg per shelf<br>Kg par étagère | 40 Kg   | 40 Kg   | 80 Kg   | 80 Kg   |
| CONTIENE<br>Contained<br>Contient               | 4 Bandejas, 12 Puntales, 16 Casquillos reguladores, 4 Tapones, 4 Pies, 2 Soportes estanteria / 4 Trays, 12 Studs, 16 Regulating bushings, 4 Caps, 4 Feet, 2 Shelving supports / 4 Rayons, 12 Montants, 16 Renforts de niveau, 4 Bouchons, 4 Pieds, 2 Supports étagère | 5 Bandejas, 16 Puntales, 20 Casquillos reguladores, 6 Tapones, 6 Pies, 3 Soportes estanteria / 5 Trays, 16 Studs, 20 Regulating bushings, 6 Caps, 6 Feet, 3 Shelving supports / 5 Rayons, 16 Montants, 20 Renforts de niveau, 6 Bouchons, 6 Pieds, 3 Supports étagère | 4 Bandejas, 12 Puntales, 16 Casquillos reguladores, 4 Tapones, 4 Pies, 2 Soportes estanteria / 4 Trays, 12 Studs, 16 Regulating bushings, 4 Caps, 4 Feet, 2 Shelving supports / 4 Rayons, 12 Montants, 16 Renforts de niveau, 4 Bouchons, 4 Pieds, 2 Supports étagère | 5 Bandejas, 16 Puntales, 20 Casquillos reguladores, 6 Tapones, 6 Pies, 3 Soportes estanteria / 5 Trays, 16 Studs, 20 Regulating bushings, 6 Caps, 6 Feet, 3 Shelving supports / 5 Rayons, 16 Montants, 20 Renforts de niveau, 6 Bouchons, 6 Pieds, 3 Supports étagère |
| MATERIAL<br>Material / Matériau                 | Resina PP<br>PP Resin / PP résine   | Resina PP<br>PP Resin / PP résine   | Resina PP<br>PP Resin / PP résine   | Resina PP<br>PP Resin / PP résine   |

| EMBALAJE / UNIDADES<br>Packing / Units<br>Emballage / Unités | 1 | 1 | 1 | 1 |
|--|---|---|---|---|
|--|---|---|---|---|



\* Colores especiales disponibles en todos los colores RAL bajo pedido. Consultar Special colours available in all RAL colours under request. Please send us your enquiry. Couleurs spéciales disponibles dans toute gamme de coloris RAL, sur demande.



Montaje en 10 minutos  
Assembly in 10 minutes  
Assemblée en 10 minutes



No se necesitan herramientas para su montaje  
No tools are needed for assembly  
Aucun outil n'est nécessaire pour l'assemblage



Heavy duty. Soporta 80kg por estante  
Heavy duty. Up to 80 kg per shelf  
Heavy duty. Jusqu'à 80 kg par étagère



944 HD



945 HD

Cajas de herramientas y estuches  
Tool boxes and organizers  
Boîtes à outils et coffrets

Productos de ordenación  
Arrangement products  
Produits de rangement

Tayg Car  
Tayg Car  
Tayg Car

Colección hogar  
Home collection  
Boîtes de rangement Home

Eco Tayg  
Eco Tayg  
Eco Tayg

Tayg Light  
Tayg Light  
Tayg Light

Tayg Build  
Tayg Build  
Tayg Build

Liste de packing  
Packing list  
Liste d'emballage



## MÓDULOS METÁLICOS

Metal stackable modules / Modules métalliques



Mod. 35/0/0

Mod. 10/2/1

| MODELO<br>Model / Modèle   | 35/0/0   | 20/2/1   | 10/2/1   | 25/0/0   |
|--|--|--|--|--|
| CÓDIGO<br>Code / Code  | 316005   | 315008   | 317002   | 318009   |
| MEDIDAS<br>Sizes / Mesures   | 305 x 145 x 328 mm   | 305 x 145 x 328 mm   | 305 x 145 x 237 mm   | 305 x 145 x 237 mm   |
| SEPARADOR<br>CAJONES<br>Drawers dividers<br>Séparateurs tiroirs    | 36 ud  | 24 ud  | 14 ud  | 26 ud  |
| MATERIAL<br>Material<br>Matériau                                   | Armazón-Chapa de acero<br>Pintura epoxi, Cajones PP<br>Frame-Steel sheet,<br>Drawers PP<br>Structure-Tôle en acier<br>Peinture époxy, Tiroirs PP | Armazón-Chapa<br>de acero, Pintura epoxi,<br>Cajones PP<br>Frame-Steel sheet,<br>Drawers PP<br>Structure-Tôle en acier<br>Peinture époxy, Tiroirs PP | Armazón-Chapa de acero<br>Pintura epoxi, Cajones PP<br>Frame-Steel sheet,<br>Drawers PP<br>Structure-Tôle en acier<br>Peinture époxy, Tiroirs PP | Armazón-Chapa de acero<br>Pintura epoxi, Cajones PP<br>Frame-Steel sheet,<br>Drawers PP<br>Structure-Tôle en acier<br>Peinture époxy, Tiroirs PP |
| EMBALAJE /<br>UNIDADES<br>Packing / Units<br>Emballage /<br>Unités | 4  | 4  | 4  | 4  |

## CONTENEDORES CAJONES

Cabinet with drawers / Casiers à tiroirs

**Etiquetas descargables en la web**  
Downloadable labels on the web / Étiquettes téléchargeables sur le web



Mod. 300/5



\* Colores especiales disponibles en todos los colores RAL bajo pedido. Consultar Special colours available in all RAL colours under request. Please send us your enquiry. Couleurs spéciales disponibles dans toute gamme de coloris RAL, sur demande.



| MODELO<br>Model / Modèle  | 300/6   | 300/3   | 300/5   |
|---|---|---|---|
| CÓDIGO<br>Code / Code   | 350009  | 351006  | 352003  |
| MEDIDAS EXTERIORES<br>Outer sizes<br>Dimensions extérieures     | 245 x 291 x 321 mm  | 245 x 291 x 321 mm  | 245 x 291 x 321 mm  |
| CAJONES<br>MEDIDAS<br>Drawers / Sizes<br>Tiroirs / Mesures      | 6<br>291 x 116 x 95 mm  | 3<br>291 x 232 x 95 mm  | 4 291 x 116 x 95 mm<br>1 291 x 232 x 95 mm                                    |
| SEPARADOR<br>CAJONES<br>Drawers dividers<br>Séparateurs tiroirs | 18 separadores-01   | 9 separadores-02  | 12 separadores-01<br>3 separadores-02   |
| MATERIAL<br>Material<br>Matériau                                | Armazón PS / Cajones PP<br>Frame PS / Drawers PP<br>Structure PS / Tiroirs PP | Armazón PS / Cajones PP<br>Frame PS / Drawers PP<br>Structure PS / Tiroirs PP | Armazón PS / Cajones PP<br>Frame PS / Drawers PP<br>Structure PS / Tiroirs PP |
| EMBALAJE /<br>UNIDADES<br>Packing / Units<br>Emballage / Unités | 2   | 2   | 2   |



## CLASIFICADORES APILABLES

Stackable classifiers unit / Racks de rangement apilables



\* Colores especiales disponibles en todos los colores RAL bajo pedido. Consultar Special colours available in all RAL colours under request. Please send us your enquiry. Couleurs spéciales disponibles dans toute gamme de coloris RAL, sur demande.



**Etiquetas descargables en la web**  
Downloadable labels on the web / Étiquettes téléchargeables sur le web



Cod. 304002



Cod. 306006



Cod. 309007



Cod. 312007

| CÓDIGO<br>Code / Code   | 304002   | 306006   | 309007   | 312007   |
|---|--|--|--|--|
| <b>MEDIDAS EXTERIORES</b><br>Outer sizes<br>Dimensions extérieures  | 360 x 170 x 190 mm   | 360 x 170 x 190 mm   | 360 x 170 x 190 mm   | 360 x 170 x 190 mm   |
| <b>GAVETAS</b><br>Drawers / Bacs                                    | 4  | 6  | 9  | 12 separadores<br>12 dividers<br>12 Séparateurs                            |
| <b>MEDIDAS GAVETAS</b><br>Drawer sizes<br>Dimensions bacs           | 160 x 170 x 80 mm  | 100 x 170 x 80 mm  | 100 x 170 x 50 mm  | 80 x 170 x 50 mm   |
| <b>MEDIDAS</b><br>Sizes / Mesures                                   | Armazón PS / Gavetas PP<br>Frame PS / Drawers PP<br>Structure PS / Bacs PP | Armazón PS / Gavetas PP<br>Frame PS / Drawers PP<br>Structure PS / Bacs PP | Armazón PS / Gavetas PP<br>Frame PS / Drawers PP<br>Structure PS / Bacs PP | Armazón PS / Gavetas PP<br>Frame PS / Drawers PP<br>Structure PS / Bacs PP |
| <b>EMBALAJE / UNIDADES</b><br>Packing / Units<br>Emballage / Unités | 4  | 4  | 4  | 4  |

## MÓDULOS APILABLES

Stackable modules / Modules empilables



\* Colores especiales disponibles en todos los colores RAL bajo pedido. Consultar Special colours available in all RAL colours under request. Please send us your enquiry. Couleurs spéciales disponibles dans toute gamme de coloris RAL, sur demande.



**Etiquetas descargables en la web**  
Downloadable labels on the web / Étiquettes téléchargeables sur le web



Cod. 347009 - 348006

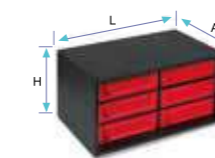

| CÓDIGO<br>Code / Code   | 346002                 | 347009  | 348006                 |
|---|------------------------|---|------------------------|
| <b>MEDIDAS EXTERIORES</b><br>Outer sizes<br>Dimensions extérieures  | 280 x 167 x 140 mm     | 280 x 167 x 140 mm                              | 280 x 167 x 140 mm     |
| <b>CAJONES</b><br>MEDIDAS<br>Drawers / Sizes<br>Tiroirs / Mesures   | 6<br>127 x 150 x 37 mm | 3<br>127 x 150 x 37 mm<br>6<br>62 x 150 x 37 mm | 12<br>62 x 150 x 37 mm |
| <b>SEPARADOR CAJONES</b><br>Drawers dividers<br>Séparateurs tiroirs | 6 unid.                | 3 unid.<br>6 unid.                              | 12 unid.               |
| <b>MATERIAL</b><br>Material<br>Matériau                             | PS                     | PS  | PS                     |
| <b>EMBALAJE / UNIDADES</b><br>Packing / Units<br>Emballage / Unités | 6                      | 6   | 6                      |

# Tayg MULTIBOX

Multibox / Multibox



\* Colores especiales disponibles en todos los colores RAL bajo pedido. Consultar Special colours available in all RAL colours under request. Please send us your enquiry. Couleurs spéciales disponibles dans toute gamme de coloris RAL, sur demande.



Multibox n°1

|   |  |
|---|--|
| <b>MODELO</b><br>Model / Modèle                                     |  |
| <b>CÓDIGO</b><br>Code / Code  | <b>301001</b>  |
| <b>MEDIDAS LxAxH</b><br>Sizes / Mesures                             | 335 x 250 x 275 mm   |
| <b>CONTIENE</b><br>Contained<br>Contient                            | Módulo + 4 estuches 22 + asa<br>Module + 4 organizers 22 + handle<br>Module + 4 coffres 22 + poignée |
| <b>MATERIAL</b><br>Material<br>Matériau                             | PP   |
| <b>EMBALAJE / UNIDADES</b><br>Packing / Units<br>Emballage / Unités | 2  |



Mod. Multibox  
Tope de seguridad  
Safety stopper  
Butée de sécurité



| MODELO<br>Model / Modèle  | Multibox n°2  | Multibox n°3  | Multibox n°2 L.  | Multibox n°3 L.  |
|---|---|---|--|--|
| <b>CÓDIGO</b><br>Code / Code  | <b>302008</b>   | <b>303005</b>   | <b>302503</b>  | <b>303500</b>  |
| <b>MEDIDAS LxAxH</b><br>Sizes / Mesures                             | 447 x 314 x 360 mm  | 530 x 376 x 430 mm  | 447 x 314 x 360 mm   | 530 x 376 x 430 mm   |
| <b>CONTIENE</b><br>Contained<br>Contient                            | Módulo + 4 estuches 23<br>Module + 4 organizers 23<br>Module + 4 coffres 23 | Módulo + 4 estuches 24<br>Module + 4 organizers 24<br>Module + 4 coffres 24 | Módulo + 4 estuches (46-26)<br>Module + 4 organizers (46-26)<br>Module + 4 coffres (46-26) | Módulo + 4 estuches (47-26)<br>Module + 4 organizers (47-26)<br>Module + 4 coffres (47-26) |
| <b>MATERIAL</b><br>Material<br>Matériau                             | PP  | PP  | PP   | PP   |
| <b>EMBALAJE / UNIDADES</b><br>Packing / Units<br>Emballage / Unités | 2   | 1   | 2  | 1  |



\* Colores especiales disponibles en todos los colores RAL bajo pedido. Consultar Special colours available in all RAL colours under request. Please send us your enquiry. Couleurs spéciales disponibles dans toute gamme de coloris RAL, sur demande.



Con función apilable para una mayor organización  
Stackable for greater organisation  
Avec fonction empilable pour une meilleure organisation

Mod. Multibox n°1

**Colores.** Base negra, mango amarillo.  
Caja verde, tapa transparente  
**Colours.** Black base, yellow handle.  
Green case, clear lid  
**Couleurs.** Base noire, anse jaune.  
Casier vert, couvercle transparent

Multibox con 4 estuches con separadores móviles 22  
Multibox with 4 organiser cases with mobile dividers 22-26  
Multi-box avec 4 casiers à séparateurs amovibles 22-26



**Medidas.** Multi-Box  
335mm (L) x 250mm (A) x 275mm (H)  
Estuche 312mm (A) x 238mm (A) x 51mm (H)  
**Dimensions.** Multi-Box 335x250x275mm  
Case 312 x 238 x 51 mm  
**Dimensions.** Multi-Box 335x250x275mm  
Casier 312 x 238 x 51 mm



Con asa de seguridad antiapertura  
Sturdy handle for easy transport  
Avec anse résistante pour faciliter le transport

Cajas de herramientas y estuches  
Tool boxes and organizers  
Boîtes à outils et coffrets

Productos de ordenación  
Arrangement products  
Produits de rangement

Tayg Car  
Tayg Car  
Tayg Car

Colección hogar  
Home collection  
Boîtes de rangement Home

Eco Tayg  
Eco Tayg  
Eco Tayg

Tayg Light  
Tayg Light  
Tayg Light

Tayg Build  
Tayg Build  
Tayg Build

Lista de packing  
Packing list  
Liste d'emballage

# TAYG CAR

Tayg Car | Tayg Car | Tayg Car



03



## SISTEMAS DE ORDENACIÓN PARA FURGONETAS

76

Van shelving systems  
Systèmes d'étagères pour utilitaires  
Ordnungssystem für Transporter

Para más información escanea el código QR  
For more information scan the QR  
Pour plus d'informations scannez le QR  
Für weitere Informationen scannen Sie die QR





# SISTEMAS DE ORDENACIÓN PARA FURGONETAS

Van shelving systems / Systèmes d'étagères pour utilitaires



**Diseño resistente**  
Robust design  
Modèle résistant



**Soporta 100 kg por estante**  
Load capacity up to 100 kg per shelf  
Supporte 100 kg par étagère



**Ideal para anclaje en el vehículo**  
Ideal for mounting on vehicle  
Idéal pour fixation au véhicule



**Fácil montaje**  
Easy to assemble  
Montage facile

**Ideal para anclaje en el vehículo**  
Ideal for mounting on vehicle  
Idéal pour fixation au véhicule

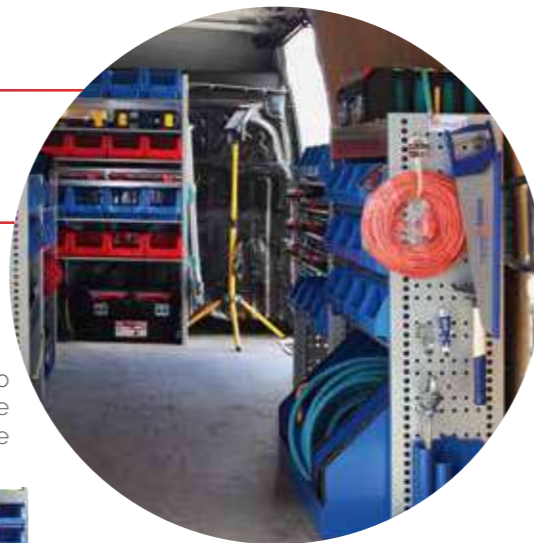

## MÓDULOS

Modules / Modules



**Módulo 1**



**Módulo 1**

|                                 |                 |                 |
|---------------------------------|-----------------|-----------------|
| <b>MODELO</b><br>Model / Modèle | <b>Módulo 1</b> | <b>Módulo 1</b> |
| <b>CÓDIGO</b><br>Code / Code    | <b>407017</b>   | <b>370014</b>   |

|                                   |                   |                   |
|-----------------------------------|-------------------|-------------------|
| <b>MEDIDAS</b><br>Sizes / Mesures | 1000 x 1200 x 300 | 1000 x 1200 x 300 |
|-----------------------------------|-------------------|-------------------|

|  |  |  |
|--|--|--|
| <b>CONTIENE</b><br>Contained<br>Contient | 1 bandeja profunda, 3 baldas gavetas<br>1 deep tray, 3 bin shelves / 1 plateau creux, 3 tablettes bacs à bec | 1 bandeja profunda, 3 baldas gavetas,<br>4 gavetas modelo 55 x 3 = 12 gavetas<br>1 deep tray, 3 bin shelves, 4 bins model 55 x 3 = 12 bins<br>1 plateau creux, 3 tablettes bacs à bec<br>à bec, 4 bacs à bec modèle 55 x 3 = 12 bacs à bec |
|--|--|--|

|   |   |   |
|---|---|---|
| <b>EMBALAJE / UNIDADES</b><br>Packing / Units<br>Emballage / Unités | 1 | 1 |
|---|---|---|



**Módulo 2**



**Módulo 2**

|                                 |                 |                 |
|---------------------------------|-----------------|-----------------|
| <b>MODELO</b><br>Model / Modèle | <b>Módulo 2</b> | <b>Módulo 2</b> |
| <b>CÓDIGO</b><br>Code / Code    | <b>407024</b>   | <b>370021</b>   |

|                                   |                   |                   |
|-----------------------------------|-------------------|-------------------|
| <b>MEDIDAS</b><br>Sizes / Mesures | 1000 x 1000 x 300 | 1000 x 1000 x 300 |
|-----------------------------------|-------------------|-------------------|

|  |  |   |
|--|--|---|
| <b>CONTIENE</b><br>Contained<br>Contient | 2 baldas gavetas, 3 baldas estuches profesionales<br>2 bin shelves, 3 shelves for special organiser trays<br>special organiser trays 2 tablettes bacs à bec, 3 tablettes coffrets professionnels | 2 baldas gavetas, 3 baldas estuches profesionales, 4 gavetas 55 x 2 = 8 gavetas, 2 estuches 430/50/25 x 3 = 6 estuches / 2 bin shelves, 3 shelves for special organiser trays, 4 bins 55 x 2 = 8 bins, 2 storage trays 430/50/25 x 3 = 6 organiser trays / 2 tablettes bacs à bec, 3 tablettes coffrets professionnels, 4 bacs à bec 55 x 2 = 8 bacs à bec, 2 coffrets 430/50/25 x 3 = 6 coffrets |
|--|--|---|

|   |   |   |
|---|---|---|
| <b>EMBALAJE / UNIDADES</b><br>Packing / Units<br>Emballage / Unités | 1 | 1 |
|---|---|---|



**Módulo 3**



**Módulo 3**

|                                 |                 |                 |
|---------------------------------|-----------------|-----------------|
| <b>MODELO</b><br>Model / Modèle | <b>Módulo 3</b> | <b>Módulo 3</b> |
| <b>CÓDIGO</b><br>Code / Code    | <b>407031</b>   | <b>370038</b>   |

|                                   |                  |                  |
|-----------------------------------|------------------|------------------|
| <b>MEDIDAS</b><br>Sizes / Mesures | 980 x 1400 x 300 | 980 x 1400 x 300 |
|-----------------------------------|------------------|------------------|

|  |   |   |
|--|---|---|
| <b>CONTIENE</b><br>Contained<br>Contient | 1 bandeja profunda, 2 baldas cajones pequeños, 2 balda cajones medianos, 2 balda cajones grandes, 8 gavetas 301 x 2 = 16 gavetas, 4 gavetas 302 x 2 = 8 gavetas, 4 gavetas 303 x 2 = 8 gavetas<br>1 deep tray, 2 small drawer shelves, 2 medium-size drawer shelves, 2 large drawer shelves / 1 plateau creux, 2 tablettes à petits tiroirs, 2 tablettes de tiroirs de taille moyenne, 2 tablettes grands tiroirs | 1 bandeja profunda, 2 baldas cajones pequeños, 2 balda cajones medianos, 2 balda cajones grandes, 8 gavetas 301 x 2 = 16 gavetas, 4 gavetas 302 x 2 = 8 gavetas, 4 gavetas 303 x 2 = 8 gavetas<br>1 deep tray, 2 small drawer shelves, 2 medium-size drawer shelves, 2 large drawer shelves, 8 bins 301 x 2 = 16 bins, 4 bins 302 x 2 = 8 bins, 4 bins 303 x 2 = 8 bins<br>1 plateau creux, 2 tablettes à petits tiroirs, 2 tablettes de tiroirs de taille moyenne, 2 tablettes grands tiroirs, 8 bacs à bec 301 x 2 = 16 bacs à bec + 4 bacs à bec 302 x 2 = 8 bacs à bec, 4 Bacs o bec 303 x 2 = 8 bacs à bec |
|--|---|---|

|   |   |   |
|---|---|---|
| <b>EMBALAJE / UNIDADES</b><br>Packing / Units<br>Emballage / Unités | 1 | 1 |
|---|---|---|

## ACCESORIOS METÁLICOS PARRILLA LATERAL

Metallic side-rack fittings / Accessoires métalliques grille latérale



**Aro Ring**  
Anneau



**Abrazadera con muelle**  
Bracket with spring  
Collier de serrage à ressort



**Pincho simple**  
Single prong  
Accroche simple



**Pincho doble**  
Double prong  
Accroche double

|                                 |                           |   |   |  |
|---------------------------------|---------------------------|---|---|--|
| <b>MODELO</b><br>Model / Modèle | <b>Aro Ring</b><br>Anneau | <b>Abrazadera con muelle</b><br>Bracket with spring<br>Collier de serrage à ressort | <b>Pincho simple</b><br>Single prong<br>Accroche simple | <b>Pincho doble</b><br>Double prong<br>Accroche double |
| <b>CÓDIGO</b><br>Code / Code    | <b>370175</b>             | <b>370182</b>   | <b>370151</b>   | <b>370168</b>  |



**Percha L**  
L Hanger  
Cintre L



**Percha XL**  
XL Hanger  
Cintre XL



**Conjunto 4 tubos**  
Set of 4 tubes  
Ensemble de 4 tubes

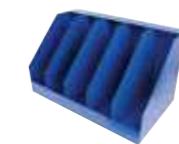

**Kit para cables / Mangueras enrolladas**  
Kit for coiled cables / Hoses  
Kit pour câbles / Tuyaux enroulés

|                                 |   |  |  |   |
|---------------------------------|---|--|--|---|
| <b>MODELO</b><br>Model / Modèle | <b>Percha L</b><br>L Hanger<br>Cintre L | <b>Percha XL</b><br>XL Hanger<br>Cintre XL | <b>Conjunto 4 tubos</b><br>Set of 4 tubes<br>Ensemble de 4 tubes | <b>Kit para cables / Mangueras enrolladas</b><br>Kit for coiled cables / Hoses<br>Kit pour câbles / Tuyaux enroulés |
| <b>CÓDIGO</b><br>Code / Code    | <b>370137</b>                           | <b>370144</b>                              | <b>370120</b>  | <b>370113</b>   |



# COLECCIÓN HOGAR

Home collection | Boîtes de rangement Home  
Haushaltskollektion



## COLECCIÓN HOGAR

80

Home Collection  
Boîtes de rangement Home  
Haushaltskollektion



# 04





# COLECCIÓN HOGAR

Home Collection / Boîtes de rangement Home



Mod.  
416590  
417597



**NOVEDAD**  
NEW / NOUVEAUTÉ

Mod.  
999260



Mod. 22



Mod. 16"



**MODELO**  
Model / Modèle

Colección hogar 30 L  
Home Collection 30 L  
Boîtes de rangement Home



Mascarillas higiénicas  
Hygienic masks  
Masques hygieniques

| CÓDIGO<br>Code / Code | ● 416590<br>● 417597<br>○ 418594 | 999260 |
|-----------------------|----------------------------------|--------|
|-----------------------|----------------------------------|--------|

| MEDIDAS<br>Sizes / Mesures | 392 x 399 x 330 mm | 175x95mm |
|----------------------------|--------------------|----------|
|----------------------------|--------------------|----------|

| CAPACIDAD<br>Capacity / Capacité | 30 L | - |
|----------------------------------|------|---|
|----------------------------------|------|---|

| MATERIAL<br>Material / Matériau | PP | 3 capas de tela, cordón de goma y puente nasal metálico<br>3 cloth capes, rubber cord and metallic nose bridge<br>3 capes en tissu, cordon en caoutchouc et pont de nez métallique |
|---------------------------------|----|--|
|---------------------------------|----|--|

| EMBALAJE / UNIDADES<br>Packing / Units<br>Emballage / Unités | 5 | 40 |
|--|---|----|
|--|---|----|



| MODELO<br>Model / Modèle                                     | 22  | 23  | 12"                                     | 14"                                     | 16"                                     |
|--|---|---|---|---|---|
| CÓDIGO<br>Code / Code  | 022593                                    | 023590                                    | 110597                                  | 111594                                  | 112591                                  |
| MEDIDAS<br>Sizes / Mesures                                   | 312 x 238 x 51 mm                         | 388 x 290 x 61 mm                         | 290 x 170 x 127 mm                      | 356 x 192 x 150 mm                      | 400 x 217 x 166 mm                      |
| CONTIENE<br>Contained / Contient                             | 21 Separadores<br>Dividers<br>Séparateurs | 21 Separadores<br>Dividers<br>Séparateurs | Bandeja / Tray /<br>Panier porte-outils | Bandeja / Tray /<br>Panier porte-outils | Bandeja / Tray /<br>Panier porte-outils |
| MATERIAL<br>Material / Matériau                              | PP  | PP  | PP                                      | PP                                      | PP                                      |
| EMBALAJE / UNIDADES<br>Packing / Units<br>Emballage / Unités | 6   | 6   | 10                                      | 6                                       | 6                                       |

# ECO TAYG

Eco Tayg | Eco Tayg | Eco Tayg



# 05



## CONTENEDORES RESIDUOS 50L - 60L - 80L 84

Waste container 50L - 60L - 80L  
Bacs à déchets 50L - 60L - 80L  
Abfallbehälter 50L - 60L - 80L



## CONTENEDORES RESIDUOS 100L - 120L 86

Waste container 100L - 120L  
Bacs à déchets 100L - 120L  
Abfallbehälter 100L - 120L



## CONTENEDORES RESIDUOS 120L CONTENEDOR JARDÍN 120L 88

Waste container 120L | Garden container 120L  
Bacs à déchets 120 | Poubelle de jardin pour déchets  
Abfallbehälter 120L | Gartenbehälter 120L



## CONTENEDORES RESIDUOS 50L - 75L - 95L 90

Waste container 50L - 75L - 95L  
Bacs à déchets 50L - 75L - 95L  
Abfallbehälter 50L - 75L - 95L



## BIDONES CON GRIFO | BIDONES CON CÁNULA 92

Jerry cans with tap | Jerry cans with spout  
Jerrican avec robinet | Bidons avec bec  
Kanister mit Zapfhahn | Kanister mit Kanülen



# CONTENEDORES RESIDUOS 50L - 60L - 80 L

Waste container 50L - 60L - 80L / Bacs à déchets 50L - 60L - 80L



\* Colores especiales disponibles en todos los colores RAL bajo pedido. Consultar Special colours available in all RAL colours under request. Please send us your enquiry. Couleurs spéciales disponibles dans toute gamme de coloris RAL, sur demande.



\* Colores especiales disponibles en todos los colores RAL bajo pedido. Consultar Special colours available in all RAL colours under request. Please send us your enquiry. Couleurs spéciales disponibles dans toute gamme de coloris RAL, sur demande.



Personalizable  
Customizable  
Personnalisable



Apertura por pedal  
Opens by pedal  
Ouverture avec pédale



50P



60P



50P



60P

**MODELO**  
Model / Modèle

**CÓDIGO**  
Code / Code

|          |          |          |          |
|----------|----------|----------|----------|
| ● 434020 | ● 435027 | ● 430022 | ● 431029 |
| ● 434037 | ● 435034 | ● 430039 | ● 431036 |
| ○ 434068 | ○ 435065 | ○ 430008 | ○ 431005 |
| ● 434013 | ● 435010 | ● 430015 | ● 431012 |

**MEDIDAS**  
Sizes / Mesures

|                    |                    |                    |                    |
|--------------------|--------------------|--------------------|--------------------|
| 400 x 430 x 509 mm | 400 x 430 x 645 mm | 400 x 430 x 509 mm | 400 x 430 x 645 mm |
|--------------------|--------------------|--------------------|--------------------|

**CAPACIDAD**  
Capacity / Capacité

|      |      |      |      |
|------|------|------|------|
| 50 L | 60 L | 50 L | 60 L |
|------|------|------|------|

**MATERIAL**  
Material / Matériau

|    |    |    |    |
|----|----|----|----|
| PP | PP | PP | PP |
|----|----|----|----|

**EMBALAJE / UNIDADES**  
Packing / Units  
Emballage / Unités

|   |   |   |   |
|---|---|---|---|
| 3 | 3 | 3 | 3 |
|---|---|---|---|



**MODELO**  
Model / Modèle

**CÓDIGO**  
Code / Code



80



80P

|          |          |
|----------|----------|
| ● 432026 | ● 433023 |
| ● 432033 | ● 433030 |
| ○ 432002 | ○ 433009 |
| ● 432019 | ● 433016 |

**MEDIDAS**  
Sizes / Mesures

|                    |                    |
|--------------------|--------------------|
| 400 x 575 x 785 mm | 400 x 575 x 785 mm |
|--------------------|--------------------|

**CAPACIDAD**  
Capacity / Capacité

|      |      |
|------|------|
| 80 L | 80 L |
|------|------|

**MATERIAL**  
Material / Matériau

|    |    |
|----|----|
| PP | PP |
|----|----|

**EMBALAJE / UNIDADES**  
Packing / Units  
Emballage / Unités

|   |   |
|---|---|
| 3 | 3 |
|---|---|



# CONTENEDORES RESIDUOS 100L - 120L

Waste container 100L - 120L / Bacs à déchets 100L - 120L



\* Colores especiales disponibles en todos los colores RAL bajo pedido. Consultar  
Special colours available in all RAL colours under request. Please send us your enquiry.  
Couleurs spéciales disponibles dans toute gamme de coloris RAL, sur demande.



Personalizable  
Customizable  
Personnalisable



Mod. 100

\* Ideal para uso en exteriores.  
Ideal for outdoor use.  
Idéal pour une utilisation en extérieur.



100



100P

MODELO  
Model / Modèle

| CÓDIGO<br>Code / Code | 100      | 100P |
|-----------------------|----------|------|
| ● 420023              | ● 421020 |      |
| ● 420030              | ● 421037 |      |
| ○ 420009              | ○ 421006 |      |
| ● 420016              | ● 421013 |      |
| ● 420108              | ● 421105 |      |
| ● 440076              | ● 441073 |      |
| ● 420238              | ● 421235 |      |

MEDIDAS  
Sizes / Mesures 600 x 568 x 770 mm 600 x 568 x 770 mm

CAPACIDAD  
Capacity / Capacité 100 L 100 L

MATERIAL  
Material / Matériau PP PP

EMBALAJE / UNIDADES  
Packing / Units 3 3  
Emballage / Unités



Mod. 100P

Apertura por pedal  
Opens by pedal  
Ouverture avec pédale

\* Ideal para uso en exteriores.  
Ideal for outdoor use.  
Idéal pour une utilisation en extérieur.



Mod. 120



\* Colores especiales disponibles en todos los colores RAL bajo pedido. Consultar  
Special colours available in all RAL colours under request. Please send us your enquiry.  
Couleurs spéciales disponibles dans toute gamme de coloris RAL, sur demande.



Personalizable  
Customizable  
Personnalisable

Asa trasera y en los laterales  
Rear and side handles  
Poignées derrière et sur les cotés



120



120P

MODELO  
Model / Modèle

| CÓDIGO<br>Code / Code | 120      | 120P |
|-----------------------|----------|------|
| ● 422027              | ● 423024 |      |
| ● 422034              | ● 423031 |      |
| ○ 422003              | ○ 423000 |      |
| ● 422010              | ● 423017 |      |
| ● 422102              | ● 423109 |      |
| ● 442070              | ● 423109 |      |
| ● 422232              | ● 423239 |      |

MEDIDAS  
Sizes / Mesures 600 x 568 x 886 mm 600 x 568 x 886 mm

CAPACIDAD  
Capacity / Capacité 120 L 120 L

MATERIAL  
Material / Matériau PP PP

EMBALAJE / UNIDADES  
Packing / Units 3 3  
Emballage / Unités



Mod. 120P



## CONTENEDORES RESIDUOS 120L

Waste container 120L / Garden container 120L



\* Colores especiales disponibles en todos los colores RAL bajo pedido. Consultar Special colours available in all RAL colours under request. Please send us your enquiry. Couleurs spéciales disponibles dans toute gamme de coloris RAL, sur demande.



Personalizable  
Customizable  
Personnalisable

\* Ideal para uso en exteriores.  
Ideal for outdoor use.  
Idéal pour une utilisation en extérieur.

\*Gran estabilidad  
Great stability  
Grande stabilité



Mod. 120P

Mod. 120 VE

Pedal antivuelco  
Anti-tipping pedal  
Pédale anti- renversement

**MODELO**  
Model / Modèle

| CÓDIGO<br>Code / Code | 120 P | 120 VE | 120 VE-P |
|-----------------------|-------|--------|----------|
| ● 443022              |       |        |          |
| ● 443015              |       |        |          |
| ○ 443008              |       | 424007 | 426001   |
| ● 443077              |       |        |          |
| ● 443237              |       |        |          |

**MEDIDAS LxAXH**  
Sizes / Mesures

**CAPACIDAD**  
Capacity / Capacité

**MATERIAL**  
Material / Matériau

**EMBALAJE / UNIDADES**  
Packing / Units

**Emballage / Unités**

## 120L CONTENEDOR JARDÍN

Bacs à déchets 120L / Poubelle de jardin pour déchets



Protección contra rayos UVA  
Protection against UV rays  
Protection contre les rayons uva

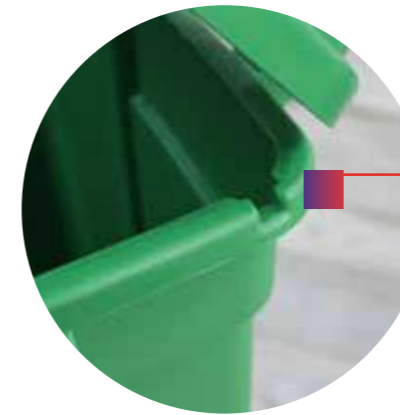

Especial hosteleria. Enganches para bolsa 85x105mm  
Special catering, hooks for bag of 85x105mm  
Restauration spéciale, crochets pour sac de 85x105mm

Tapa abatible  
Hinged lid  
Couvercle rabattable



Mod. 120 VE-P

Contenedor de residuos  
EcoTayg con 120L de capacidad  
EcoTayg waste bin with 120L capacity  
Conteneur à déchets EcoTayg d'une capacité de 120L

Protección contra rayos UVA  
UV-A protection  
Protection anti-rayons UVA

Diseño anti-vuelco  
Anti-tip design  
Design anti-renversement

Dispone de Asa trasera y laterales para su transporte, así como de ruedas para su fácil transporte  
Rear and side handles and wheels for easy transport  
Dispose de poignée arrière et de roues pour son transport facile

**Medidas.**  
600mm (L) x 568mm (A) x 886mm (H)  
**Dimensions.** 600x568x886mm  
**Dimensions.** 600x568x886mm

Con pedal central para fácil apertura  
With pedal for easy opening  
Avec pédale centrale pour une ouverture facile





## CONTENEDOR RESIDUOS 50L - 75L

Waste container 50L - 75L / Bacs à déchets 50L - 75L



\* Colores especiales disponibles en todos los colores RAL bajo pedido. Consultar Special colours available in all RAL colours under request. Please send us your enquiry. Couleurs spéciales disponibles dans toute gamme de coloris RAL, sur demande.



Mod. 75



50



75

### MODELO Model / Modèle

### CÓDIGO Code / Code

|          |          |
|----------|----------|
| ● 412028 | ● 411021 |
| ● 412035 | ● 411038 |
| ○ 412004 | ○ 411007 |
| ● 412011 | ● 411014 |
| ● 412103 | ● 411106 |

### MEDIDAS Sizes / Mesures

|                    |                    |
|--------------------|--------------------|
| 410 x 400 x 510 mm | 600 x 402 x 560 mm |
|--------------------|--------------------|

### CONTIENE Contained / Contient

|   |   |
|---|---|
| Con cierres<br>With fastener / À attaches | Con cierres<br>With fastener / À attaches |
|---|---|

### CAPACIDAD Capacity / Capacité

|      |      |
|------|------|
| 50 L | 75 L |
|------|------|

### MATERIAL Material / Matériau

|    |    |
|----|----|
| PP | PP |
|----|----|

### EMBALAJE /

### UNIDADES Packing / Units Emballage / Unités

|   |   |
|---|---|
| 4 | 4 |
|---|---|



Mod. 50

## CONTENEDOR RESIDUOS 95L

Waste container 95L / Bacs à déchets 95L



\* Colores especiales disponibles en todos los colores RAL bajo pedido. Consultar Special colours available in all RAL colours under request. Please send us your enquiry. Couleurs spéciales disponibles dans toute gamme de coloris RAL, sur demande.



Mod. 95



95

### MODELO Model / Modèle

### CÓDIGO Code / Code

|          |
|----------|
| ● 410024 |
| ● 410031 |
| ○ 410000 |
| ● 410017 |
| ● 410109 |

### MEDIDAS Sizes / Mesures

|                    |
|--------------------|
| 600 x 402 x 730 mm |
|--------------------|

### CONTIENE Contained / Contient

|   |
|---|
| Con cierres<br>With fastener / À attaches |
|---|

### CAPACIDAD Capacity / Capacité

|      |
|------|
| 95 L |
|------|

### MATERIAL Material / Matériau

|    |
|----|
| PP |
|----|

### EMBALAJE /

### UNIDADES Packing / Units Emballage / Unités

|   |
|---|
| 4 |
|---|



Cierre de seguridad  
Safety fastener  
Fermeture de sécurité



## BIDONES CON GRIFO

Jerry cans with tap / Jerry cans with spout



\* Colores especiales disponibles en todos los colores RAL bajo pedido. Consultar Special colours available in all RAL colours under request. Please send us your enquiry. Couleurs spéciales disponibles dans toute gamme de coloris RAL, sur demande.



Apto para uso alimentario  
Food graded  
Apte pour l'utilisation alimentaire



Tapón en el interior  
Spout inside of the jerry can  
Bouchon inclusà l'intérieur du bidon



Cod. 610004



Cod. 602368

Cod. 602368

### TAPONES Caps / Bouchons



| CÓDIGO<br>Code / Code | 609008 | 610004 | 617003 |
|-----------------------|--------|--------|--------|
|-----------------------|--------|--------|--------|

| CAPACIDAD<br>Capacity / Capacité | 5 l. y 10 l. | 20 l. y 30 l. | 5 l., 10 l., 20 l. y 30 l. |
|----------------------------------|--------------|---------------|----------------------------|
|----------------------------------|--------------|---------------|----------------------------|



| CÓDIGO<br>Code / Code | 601361 | 602368 | 603365 | 604362 |
|-----------------------|--------|--------|--------|--------|
|-----------------------|--------|--------|--------|--------|

| CAPACIDAD<br>Capacity / Capacité | 5 L | 10 L | 20 L | 30 L |
|----------------------------------|-----|------|------|------|
|----------------------------------|-----|------|------|------|

| MEDIDAS<br>Sizes / Mesures | 230 x 145 x 257 mm | 265 x 200 x 307 mm | 345 x 234 x 377 mm | 400 x 237 x 464 mm |
|----------------------------|--------------------|--------------------|--------------------|--------------------|
|----------------------------|--------------------|--------------------|--------------------|--------------------|

| MATERIAL<br>Material / Matériau | HDPE | HDPE | HDPE | HDPE |
|---------------------------------|------|------|------|------|
|---------------------------------|------|------|------|------|

| EMBALAJE /<br>UNIDADES<br>Packing / Units<br>Emballage / Unités | 6 | 6 | 5 | 5 |
|---|---|---|---|---|
|---|---|---|---|---|

Toma de aire para un vertido uniforme  
Air intake for uniform pouring  
Prise d'air pour une décharge uniforme

## BIDONES CON CÁNULA

Jerrican avec robinet / Bidons avec bec

Toma de aire para un vertido uniforme  
Air intake for uniform pouring  
Prise d'air pour une décharge uniforme

Cod. 602351

Presión hidráulica  
200 KPa  
Hydraulic pressure  
Pression hydraulique



Homologados para transporte de mercancías peligrosas clases 3, 6.1, 8 y 9  
Norma ADR (Transporte Internacional Carretera)  
Norma RID (Transporte Internacional por Ferrocarril)  
Norma IMDG (Transporte Internacional Marítimo)  
Norma IATA/OACI (Transporte Internacional Aéreo)  
Approved for transporting Class 3, 6.1, 8, 9 dangerous goods  
ADR (International Road Transport) Regulation  
RID (International Railway Transport) Regulation  
IMDG (International Maritime Transport) Regulation  
IATA/OACI (International Air Transport) Regulation  
Homologation pour le transport de marchandises dangereuses classées 3, 6.1, 8 et 9  
Norme ADR (Transport international sur Route)  
Norme RID (Transport international par Train)  
Norme IMDG (Transport International Maritime)  
Norme IATA/OACI (Transport International Aérien)



MODELO  
Model /  
Modèle

| CÓDIGO<br>Code / Code | 605000 | 606007 | 618000 |
|-----------------------|--------|--------|--------|
|-----------------------|--------|--------|--------|

| CAPACIDAD<br>Capacity / Capacité | 5 L y 10 L | 20 L y 30 L | Válido para para todos los modelos de bidones |
|----------------------------------|------------|-------------|---|
|----------------------------------|------------|-------------|---|

| CÓDIGO<br>Code / Code | 601354 | 602351 | 603358 | 604355 |
|-----------------------|--------|--------|--------|--------|
|-----------------------|--------|--------|--------|--------|

| CAPACIDAD<br>Capacity / Capacité | 5 L | 10 L | 20 L | 30 L |
|----------------------------------|-----|------|------|------|
|----------------------------------|-----|------|------|------|

| MEDIDAS<br>Sizes / Mesures | 230 x 145 x 257 mm | 265 x 200 x 307 mm | 345 x 234 x 377 mm | 400 x 237 x 464 mm |
|----------------------------|--------------------|--------------------|--------------------|--------------------|
|----------------------------|--------------------|--------------------|--------------------|--------------------|

| MATERIAL<br>Material / Matériau | HDPE | HDPE | HDPE | HDPE |
|---------------------------------|------|------|------|------|
|---------------------------------|------|------|------|------|

| EMBALAJE /<br>UNIDADES<br>Packing / Units<br>Emballage / Unités | 6 | 6 | 5 | 5 |
|---|---|---|---|---|
|---|---|---|---|---|



\* Colores especiales disponibles en todos los colores RAL bajo pedido. Consultar Special colours available in all RAL colours under request. Please send us your enquiry. Couleurs spéciales disponibles dans toute gamme de coloris RAL, sur demande.

| CLASE<br>Class<br>Classe | GRUPO<br>Group<br>Groupe | DESCRIPCIÓN<br>Description<br>Description | EJEMPLOS<br>Examples / Exemple |
|--------------------------|--------------------------|---|--------------------------------|
|--------------------------|--------------------------|---|--------------------------------|

|   |   |             |   |
|---|---|-------------|---|
| 3 | Y | INFLAMABLES | Gasolina, gasoil, otros hidrocarburos, acetona, alcoholes (metanol, etanol...) aldehidos, benceno, tolueno, xileno, éteres, ésteres, aceites, disolventes, lacas, pinturas, esmaltes, barniz...<br>Gasoline, diesel, other hydrocarbons, acetone, alcohols (methanol, ethanol, etc.), aldehydes, benzene, toluene, xylene, ethers, esters, oils, solvents, lacquers, paints, enamels, varnish, etc.<br>Essence, diesel, autres hydrocarbures, acétone, alcools (méthanol, éthanol...), aldéhydes, benzène, toluène, xylène, éthers, esters, huiles, solvants, laques, peintures, émaux, vernis... |
|---|---|-------------|---|

|     |   |                             |  |
|-----|---|-----------------------------|--|
| 6.1 | Y | TÓXICOS<br>TOXIC<br>TOXIQUE | Anilinas, cloroformo, desinfectantes, plaguicidas, bencidina y compuestos de mercurio, plomo, bario, berilio, arsénio, antimonio talio, cianuro...<br>Anilines, chloroform, disinfectants, pesticides, benzidine, and compounds of mercury, lead, barium, beryllium, arsenic, antimony, thallium, cyanide, etc.<br>Anilines, chloroforme, désinfectants, pesticides, benzidine et composés de mercure, plomb, baryum, béryllium, arsenic, thallium antimoine, cyanure... |
|-----|---|-----------------------------|--|

|   |   |                                     |  |
|---|---|-------------------------------------|--|
| 8 | Y | CORROSIVOS<br>CORROSIVE<br>CORROSIF | Ácidos (sulfúrico, nítrico, fosfórico, acético, fórmico...) sulfumán, Hidróxidos de potasio, sosa, litio... Lejías, amoniaco, electrolitos, soluciones cáusticas...<br>Acids (sulphuric, nitric, phosphoric, acetic, formic, etc.), hydrochloric acid<br>Hydroxides of: potassium, soda, lithium, etc.<br>Bleaches, ammonia, electrolytes, caustic solutions, etc. |
|---|---|-------------------------------------|--|

|   |   |                                |  |
|---|---|--------------------------------|--|
| 9 | Y | VARIOS<br>VARIOUS<br>PLUSIEURS | Amiantos, difenilos policlorados, material líquido peligroso para el medio ambiente...<br>Asbestos, polychlorinated biphenyl, environmentally harmful liquid material, etc.<br>Amiante, biphényles polychlorés, matière liquide dangereuse pour l'environnement... |
|---|---|--------------------------------|--|



Embudo  
Funnel/ Entonnoir



### TAPONES Y CÁNULAS Caps and spouts / Bouchons et canule

| CÓDIGO<br>Code / Code | 607004 | 608001 | 616006 |
|-----------------------|--------|--------|--------|
|-----------------------|--------|--------|--------|

| CAPACIDAD<br>Capacity / Capacité | 5 L y 10 L | 20 L y 30 L | 5 L., 10 L., 20 L y 30 L |
|----------------------------------|------------|-------------|--------------------------|
|----------------------------------|------------|-------------|--------------------------|



Con visor  
With sight  
Avec viseur

Con visor  
With sight  
Avec viseur



# ACCESORIOS ELÉCTRICOS

Electrical accessories | Accessoires électriques  
Elektrozubehör

# 06



## PROYECTOR LED 96

Led worklight  
Projecteur led  
Led strahler



## PROYECTOR LED CON SOPORTE PROYECTOR LED CON TRÍPODE 98

Led worklight with stand | Led worklight with tripod  
Projecteur led avec support | Projecteur led  
avec trépied  
Led strahler mit Ständer | Led strahler mit stativ



## PROLONGADORES ELÉCTRICOS BASES MÚLTIPLES 100

Extension cables | Multiple sockets  
Rallonges électriques | Prises multiples  
Verlängerungskabel | Mehrfachsteckdosen



## BASES MÚLTIPLES 102

Multiple sockets  
Prises multiples  
Mehrfachsteckdosen



## LÁMPARAS LED 104

Penlight led  
Lampes à led  
LED-Lampen



## ENROLLACABLES 106

Cable reels  
Enrouleur  
Kabeltrommeln



# PROYECTOR LED

Led worklight / Projecteur led

LED



WATERPROOF  
IP65  
PROTECTION



**\*CÓDIGO. 520600**  
Display package  
"tayg light"  
Box pallet option  
Paquet d'affichage



**\*CÓDIGO. 519604**  
Kit proyector led "tayg light" (box pallet) incluye:  
Kit led worklight "tayg light" (box pallet) include:  
Ensemble projecteur led "tayg light" palette  
expo inclue:

- 48 LED 10W IP65 800lm
- 38 LED 20W IP65 1600lm
- 18 LED 30W IP65 2400lm
- 14 LED 50W IP65 4000lm



Ángulo de haz  
Beam angle  
Angle de faisceau



Sensor de movimiento  
Motion sensor  
Capteur de mouvement



10 - 2000 lux Luz regulable  
Adjustable light  
Lumière réglable



10 s - 7 min lux  
Configuración de tiempo  
Time setting / Réglage de l'heure

Ángulo de haz  
Beam angle  
Angle de faisceau



Cod. 510601

Cod. 511608

Cod. 513602



Cod.512612

Cod.521607



120°

| MODELO<br>Model / Modèle | 10W IP65 800lm<br>Projector led negro<br>Led worklight black<br>Projecteur led noir | 20W IP65 1600lm<br>Projector led negro<br>Led worklight black<br>Projecteur led noir | 30W IP65 2400lm<br>Projector led negro<br>Led worklight black<br>Projecteur led noir | 50W IP65 4000lm<br>Projector led negro<br>Led worklight black<br>Projecteur led noir | 100W IP65 8000lm<br>Projector led negro<br>Led worklight black<br>Projecteur led noir |
|--------------------------|---|--|--|--|---|
|--------------------------|---|--|--|--|---|

| CÓDIGO<br>Code / Code   | 510601             | 511608             | 512605             | 513602             | 514609             |
|---|--------------------|--------------------|--------------------|--------------------|--------------------|
| MEDIDAS<br>Sizes / Mesures                                      | 125 x 50 x 116 mm  | 150 x 50 x 138 mm  | 185 x 50 x 178 mm  | 211 x 50 x 205 mm  | 334 x 50 x 292 mm  |
| POT. MÁXIMA<br>Max Power<br>Puissance maximale                  | 10W - 800Lm        | 20W - 1600Lm       | 30W - 2400Lm       | 50W - 4000Lm       | 100W - 8000Lm      |
| VOLTAJE<br>Voltage / Tension                                    | 220-240V ~ 50-60Hz | 220-240V ~ 50-60Hz | 220-240V ~ 50-60Hz | 220-240V ~ 50-60Hz | 220-240V ~ 50-60Hz |
| EMBALAJE /<br>UNIDADES<br>Packing / Units<br>Emballage / Unités | 24                 | 24                 | 4                  | 12                 | 4                  |

MODELO  
Model / Modèle

30W IP54 2400lm  
Projector led con sensor de luz y movimiento  
Led worklight black with  
light and motion sensor  
Projecteur led avec cellule de  
lumière et de mouvement

50W IP54 4000lm  
Projector led con sensor de luz y  
movimiento  
Led worklight black with light  
and motion sensor  
Projecteur led avec cellule de  
lumière et de mouvement

200W IP65 24000lm  
Projector led negro  
Led worklight black  
Projecteur led noir

| CÓDIGO<br>Code / Code   | 512612            | 513619            | 521607            |
|---|-------------------|-------------------|-------------------|
| MEDIDAS<br>Sizes / Mesures                                      | 185 x 70 x 216 mm | 211 x 70 x 243 mm | 400 x 91 x 320 mm |
| POT. MÁXIMA<br>Max Power<br>Puissance maximale                  | 30W - 2400Lm      | 50W - 4000lm      | 200W - 24000lm    |
| VOLTAJE<br>Voltage / Tension                                    | 220-240V ~ 50Hz   | 220-240V ~ 50Hz   | 220-240V ~ 50Hz   |
| EMBALAJE /<br>UNIDADES<br>Packing / Units<br>Emballage / Unités | 12                | 4                 | 3                 |

Cajas de herramientas y estuches  
Tool boxes and organizers  
Boîtes à outils et coffrets

Productos de ordenación  
Arrangement products  
Produits de rangement

Tayg Car  
Tayg Car  
Tayg Car

Colección hogar  
Home collection  
Boîtes de rangement Home

Eco Tayg  
Eco Tayg  
Eco Tayg

Tayg Light  
Tayg Light  
Tayg light

Tayg Build  
Tayg Build  
Tayg Build

Lista de packing  
Packing list  
Liste d'emballage



## PROYECTOR LED CON SOPORTE

Led worklight with stand / Led worklight with tripod

LED



Tiempo de trabajo. 2 Horas  
Work time / Temps de travail



Recargable USB  
Rechargeable usb  
Rechargeable par USB



Tiempo de carga. 4-5 horas  
Work charge  
Tiempo de carga



Ángulo de haz  
Beam angle  
Angle de faisceau



Micro USB 1 m  
Micro USB / Micro USB



Cod. 515606



Cod. 522604



MODELO  
Model / Modèle

Proyector led 20W IP54  
recargable 1400lm  
Led worklight 20W IP54  
rechargeable 1400lm  
Projecteur led 20W IP54  
rechargeable 1400lm

Proyector led 30W IP65  
con soporte 2400lm  
Led worklight 30W IP65  
with stand 2400lm  
Projecteur led 30W IP65  
avec support 2400lm

Proyector led 50W IP65  
con soporte 4000lm  
Led worklight 50W IP65  
with stand 4000lm  
Projecteur led 50W IP65  
avec support 4000lm

| CÓDIGO<br>Code / Code   | 522604                   | 515606                             | 516603                             |
|---|--------------------------|------------------------------------|------------------------------------|
| MEDIDAS<br>Sizes / Mesures                                      | 174 x 126 x 234 mm       | 220 x 205 x 315 mm                 | 295 x 210 x 365 mm                 |
| POT. MÁXIMA<br>Max Power<br>Puissance maximale                  | 20W - 1400Lm             | 30W - 2400Lm                       | 50W - 4000Lm                       |
| VOLTAJE<br>Voltage / Tension                                    | 220-240V ~ 50Hz          | 220-240V ~ 50-60Hz                 | 220-240V ~ 50-60Hz                 |
| CABLE<br>Cable / Cable  | DC 5V 2A - 1 M micro USB | H05RN-F 3G 1.0mm <sup>2</sup> 1.5m | H05RN-F 3G 1.0mm <sup>2</sup> 1.5m |
| EMBALAJE /<br>UNIDADES<br>Packing / Units<br>Emballage / Unités | 2                        | 8                                  | 4                                  |

## PROYECTOR LED CON TRÍPODE

Projecteur led avec support / Projecteur led avec trépied

LED



Cod. 517600



Cod. 518607

MODELO  
Model / Modèle

Proyector led 50W IP65  
con tripode 4000lm  
Led worklight 50W IP65  
with tripod 4000lm  
Projecteur led 50W IP65  
avec trépied 4000lm

Proyector led 2x50W IP65  
con tripode 8000lm  
Led worklight 2x50W IP65  
with tripod 8000lm  
Projecteur led 2x50W IP65  
avec trépied 8000lm

| CÓDIGO<br>Code / Code   | 517600                             | 518607                           |
|---|------------------------------------|----------------------------------|
| MEDIDAS<br>Sizes / Mesures                                      | 800 x 800 x 1455 mm                | 860 x 860 x 1925 mm              |
| POT. MÁXIMA<br>Max Power<br>Puissance maximale                  | 50W - 4000Lm                       | 2 x 50W 8000Lm                   |
| VOLTAJE<br>Voltage / Tension                                    | 220-240V ~ 50-60Hz                 | 220-240V ~ 50-60Hz               |
| CABLE<br>Cable / Cable  | H05RN-F 3G 1.0mm <sup>2</sup> 2.5m | H05RN-F 3G 1.0mm <sup>2</sup> 3m |
| EMBALAJE /<br>UNIDADES<br>Packing / Units<br>Emballage / Unités | 4                                  | 4                                |



## PROLONGADORES ELÉCTRICOS

Extension cables / Multiple sockets



Protección para niños  
Protection for children  
Protection pour enfants



\*Listo para exposición  
Ready to POS  
Pret pour l'exposition

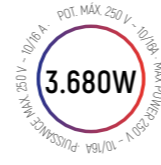
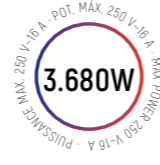

Protección para niños  
Protection for children  
Protection pour enfants



\*Listo para exposición  
Ready to POS / Pret pour l'exposition



Cod.  
571008

Cod.  
575006

| CÓDIGO<br>Code / Code   | 570001            | 571008            | 572005            |
|---|-------------------|-------------------|-------------------|
| POT. MÁXIMA<br>Max Power<br>Puissance maximale                  | 250V~16A 3.680W   | 250V~16A 3.680W   | 250V~16A 3.680W   |
| CLAVIJA Y BASE<br>Plug and socket<br>Prise + prise électrique   | 2P+T              | 2P+T              | 2P+T              |
| CABLE<br>Cable / Cable  | H05VV-F 3G1,5 2 M | H05VV-F 3G1,5 3 M | H05VV-F 3G1,5 4 M |
| EMBALAJE /<br>UNIDADES<br>Packing / Units<br>Emballage / Unités | 10                | 10                | 10                |



| CÓDIGO<br>Code / Code   | 575006             | 576003             | 577000             |
|---|--------------------|--------------------|--------------------|
| POT. MÁXIMA<br>Max Power<br>Puissance maximale                  | 250V~16A 3.680W    | 250V~16A 3.680W    | 250V~16A 3.680W    |
| CLAVIJA Y BASE<br>Plug and socket<br>Prise + prise électrique   | 2P+T               | 2P+T               | 2P+T               |
| CABLE<br>Cable / Cable  | H05VV-F 3G1,5 10 M | H05VV-F 3G1,5 15 M | H05VV-F 3G1,5 25 M |
| EMBALAJE /<br>UNIDADES<br>Packing / Units<br>Emballage / Unités | 6                  | 6                  | 6                  |

## BASES MÚLTIPLES

Rallonges électriques / Prises multiples

NOVEDAD  
NEW / NOUVEAUTE



**MODELO**  
Model / Modèle

**3 BASES 2P + T con interruptor + 2 USB**  
3 sockets 2P + T with switch + 2USB  
3 entrées 2P + T avec interrupteur + 2 USB

**3 BASES 2P + T con interruptor**  
3 sockets 2P + T with switch  
3 entrées 2P + T avec interrupteur

**4 BASES 2P + T con interruptor**  
4 sockets 2P + T with switch  
4 entrées 2P + T avec interrupteur

| CÓDIGO<br>Code / Code   | 823602             | 801600                | 806605                |
|---|--------------------|-----------------------|-----------------------|
| POT. MÁXIMA<br>Max Power<br>Puissance maximale                  | 250V ~ 16A 3680W   | 250 V ~ 10/16A 3.680W | 250 V ~ 10/16A 3.680W |
| CABLE<br>Cable / Cable  | H05VV-F 3G1,5 1,4M | H05VV-F 3G1,5 1,4 M   | H05VV-F 3G1,5 1,4 M   |
| EMBALAJE /<br>UNIDADES<br>Packing / Units<br>Emballage / Unités | 10                 | 10                    | 10                    |



\*Listo para exposición  
Ready to POS  
Pret pour l'exposition

**MODELO**  
Model / Modèle

**5 BASES 2P + T con interruptor**  
5 sockets 2P + T with switch  
5 entrées 2P + T avec interrupteur

**6 BASES 2P + T con interruptor**  
6 sockets 2P + T with switch  
6 entrées 2P + T avec interrupteur

| CÓDIGO<br>Code / Code   | 808609                | 811609                |
|---|-----------------------|-----------------------|
| POT. MÁXIMA<br>Max Power<br>Puissance maximale                  | 250 V ~ 10/16A 3.680W | 250 V ~ 10/16A 3.680W |
| CABLE<br>Cable / Cable  | H05VV-F 3G1,5 1,4 M   | H05VV-F 3G1,5 1,4 M   |
| EMBALAJE /<br>UNIDADES<br>Packing / Units<br>Emballage / Unités | 10                    | 10                    |



# BASES MÚLTIPLES

Multiple sockets / Prises multiples



Protección para niños  
Protection for children  
Protection pour enfants

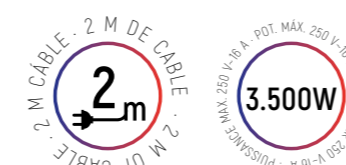

Cod. 814600

Cod. 818608

\* Tienen una protección contra sobretensión. Ideal para dispositivos electrónicos.  
It has an overvoltage protection. Ideal for electronic devices.  
Ils ont une protection contre les surtensions. Idéal pour les appareils électroniques.



| MODELO<br>Model / Modèle | 4 bases 2p + t con interruptor y protección sobre-tensión<br>4 sockets 2p + t with switch and voltage protection<br>4 entrées 2p + t avec interrupteur et parasurtenseur | 6 bases 2p + t con interruptor y protección sobre-tensión<br>6 sockets 2p + t with switch and voltage protection<br>6 entrées 2p + t avec interrupteur et parasurtenseur | 8 bases 2p + t con interruptor y protección sobre-tensión<br>8 sockets 2P + T with switch and voltage protection<br>8 entrées 2P + T avec interrupteur et parasurtenseur |
|--------------------------|--|--|--|
|--------------------------|--|--|--|

| CÓDIGO<br>Code / Code                          | 814600              | 816604              | 818608              |
|--|---------------------|---------------------|---------------------|
| POT. MÁXIMA<br>Max Power<br>Puissance maximale | 250 V - 16A 3.500W  | 250 V ~ 16A 3.500W  | 250 V ~ 16A 3.500W  |
| CABLE<br>Cable / Cable                         | H05VV-F 3G1.5 1.5 M | H05VV-F 3G1.5 1.5 M | H05VV-F 3G1.5 1.5 M |

| EMBALAJE / UNIDADES<br>Packing / Units<br>Emballage / Unités | 6 | 6 | 6 |
|--|---|---|---|
|--|---|---|---|



Cod. 836008



Goma neopreno  
Rubber neoprene  
Caoutchouc néoprène



Cod. 834004



| MODELO<br>Model / Modèle | 4 bases 2P + T con tapa e interruptor<br>4 sockets 2P + T with cover and switch<br>4 entrées 2P + T avec couvercle et interrupteur | 6 bases 2P + T con tapa e interruptor<br>6 sockets 2P + T with cover and switch<br>6 entrées 2P + T avec couvercle et interrupteur |
|--------------------------|--|--|
|--------------------------|--|--|

| CÓDIGO<br>Code / Code                          | 834004   | 836008   |
|--|--|--|
| POT. MÁXIMA<br>Max Power<br>Puissance maximale | 250V-16A 3.500W  | 250V-16A 3.500W  |
| CABLE<br>Cable / Cable                         | H07RN-F 3G1.5 2m (Goma-Neopreno)<br>H07RN-F 3G1.5 2m (Rubber-Neoprene)<br>H07RN-F 3G1.5 2m (Caoutchouc néoprène) | H07RN-F 3G1.5 2m (Goma-Neopreno)<br>H07RN-F 3G1.5 2m (Rubber-Neoprene)<br>H07RN-F 3G1.5 2m (Caoutchouc néoprène) |

| EMBALAJE / UNIDADES<br>Packing / Units<br>Emballage / Unités | 6 | 6 |
|--|---|---|
|--|---|---|



# LÁMPARAS LED

Penlight led / Lampes à led



Carga usb  
USB charge  
Recharge usb



Imán y gancho en la parte inferior  
Hook & Magnet on the bottom  
Crochet et aimant de fond



Luz frontal  
Head light  
Lampe frontale



Imán en la parte superior  
Magnet on the top  
Aimant sur le dessus



Base retráctil / pinza  
Retractable base/clamp  
Base rétractable / pince



Cod.  
504600



180o Rotación  
180o Rotate  
180o Rotation

Cod.  
505607



Cod.  
506604



180o Rotación  
180o Rotate  
180o Rotation



Imán en la parte inferior  
Magnet on the bottom  
Aimant de fond



Luz LED en parte superior  
Led light on the top  
Lampe led sur le dessus



Cabezal linterna  
Flashlight head  
Tête de lampe de poche



Puerto micro USB  
Micro USB Port  
Port micro usb

Cuello de cisne flexible  
Flexible gooseneck head  
Col de cygne flexible

Cabezal trabajo led  
Worklight head  
Tête de lampe de travail

Cod. 507601



MODELO  
Model / Modèle

Linterna frontal multifuncional  
Multifunctional head lamp  
Lampe frontale multifonctionnelle

Led trabajo multifunción X5  
Multifunction led worklight X5  
Lampe de travail led multifunction X5

MODELO  
Model / Modèle

Lámpara de trabajo portátil  
Led work and flash light  
Lampe de travail portable

Led 3 en 1 Kit de luz recargable  
3 in 1 Led rechargeable light kit  
Kit d'éclairage rechargeable 3 en 1 led

|                       |        |        |
|-----------------------|--------|--------|
| CÓDIGO<br>Code / Code | 504600 | 505607 |
|-----------------------|--------|--------|

|  |        |        |
|--|--------|--------|
| POT. MÁXIMA<br>Max Power<br>Puissance maximale | 150 LM | 180 LM |
|--|--------|--------|

|  |   |   |
|--|---|---|
| EMBALAJE / UNIDADES<br>Packing / Units<br>Emballage / Unités | 6 | 6 |
|--|---|---|

|                       |        |        |
|-----------------------|--------|--------|
| CÓDIGO<br>Code / Code | 506604 | 507601 |
|-----------------------|--------|--------|

|  |            |        |
|--|------------|--------|
| POT. MÁXIMA<br>Max Power<br>Puissance maximale | COB 110 LM | 380 LM |
|--|------------|--------|

|  |   |   |
|--|---|---|
| EMBALAJE / UNIDADES<br>Packing / Units<br>Emballage / Unités | 6 | 6 |
|--|---|---|



# ENROLLACABLES

Cable reels / Enrouleur



\* Colores especiales disponibles en todos los colores RAL bajo pedido. Consultar Special colours available in all RAL colours under request. Please send us your enquiry. Couleurs spéciales disponibles dans toute gamme de coloris RAL, sur demande.



Eficiencia logística  
Logistic efficiency  
Efficacité logistique



IP 20  
PROTECTION

IP 20  
PROTECTION



\* Colores especiales disponibles en todos los colores RAL bajo pedido. Consultar Special colours available in all RAL colours under request. Please send us your enquiry. Couleurs spéciales disponibles dans toute gamme de coloris RAL, sur demande.



Eficiencia logística  
Logistic efficiency  
Efficacité logistique



Mod.  
734601

\* HOGAR-BRICOLAGE  
Home-DIY / Home-DIY

Carrete de plástico  
Plastic spool  
Bobine en plastique



Mod.  
749605

Soporte metálico  
Metal bracket  
Support en métalique



\* Taller-industrias  
Workshop-industry  
Atelier industries

| CÓDIGO<br>Code / Code   | 714603  | 729607  | 734601  |
|---|---|---|---|
| <b>POT. MÁXIMA</b><br>Max Power<br>Puissance maximale               | 230 V ~ 14A 3.200W  | 230 V ~ 14A 3.200W  | 230 V ~ 14A 3.200W  |
| <b>BASES</b><br>Sockets / Entrées                                   | 4 (2P+T) con termostato<br>4 (2P+T) with thermostat<br>4 (2P+T) avec thermostat | 4 (2P+T) con termostato<br>4 (2P+T) with thermostat<br>4 (2P+T) avec thermostat | 4 (2P+T) con termostato<br>4 (2P+T) with thermostat<br>4 (2P+T) avec thermostat |
| <b>CABLE</b><br>Cable / Cable                                       | H05VV-F 3G1,5 5 M   | H05VV-F 3G1,5 10 M  | H05VV-F 3G1,5 15 M  |
| <b>EMBALAJE / UNIDADES</b><br>Packing / Units<br>Emballage / Unités | 10  | 10  | 6   |

\*OPCIÓN BOX PALLET  
Box - pallet option  
Option palette expo

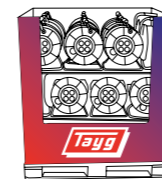

**MEDIDAS BOX-PALET**  
box-palet sizes  
Mesures palette expo  
1100 x 680 x 1164 mm

| CÓDIGO<br>Code / Code   | 749605  | 772603  | 777608  |
|---|---|---|---|
| <b>POT. MÁXIMA</b><br>Max Power<br>Puissance maximale                 | 250 V ~ 16A 4.000W  | 250 V ~ 16A 4.000W  | 250 V ~ 16A 4.000W  |
| <b>BASES</b><br>Sockets / Entrées                                     | 4 (2P+T) con termostato<br>4 (2P+T) with thermostat<br>4 (2P+T) avec thermostat | 4 (2P+T) con termostato<br>4 (2P+T) with thermostat<br>4 (2P+T) avec thermostat | 4 (2P+T) con termostato<br>4 (2P+T) with thermostat<br>4 (2P+T) avec thermostat |
| <b>CABLE</b><br>Cable / Cable   | H05VV-F 3G1,5 15 M  | H05VV-F 3G1,5 25 M  | H05VV-F 3G1,5 50 M  |
| <b>DIÁMETRO DE CARRETE</b><br>Spool diameter<br>Diamètre de la bobine | 210 MM  | 210 MM  | 270 mm  |
| <b>EMBALAJE / UNIDADES</b><br>Packing / Units<br>Emballage / Unités   | 2   | 1   | 1   |



## ENROLLACABLES

Cable reels / Enrouleur



Mod.  
774607



Carrete de plástico  
Plastic spool  
Bobine en plastique

Base aérea  
Air base  
Base aérienne



Mod.  
775505



Soporte y carrete metálico  
Metal spool and metal frame  
Support et bobine en métallique

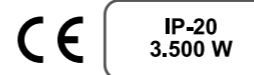

\*OPCIÓN BOX PALLET  
Box - pallet option  
Option palette expo

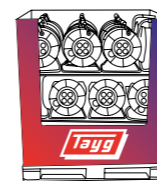

MEDIDAS BOX-PALET  
box-palet sizes  
Mesures palette expo

1020 x 805 x 1000mm

|                              |               |
|------------------------------|---------------|
| <b>CÓDIGO</b><br>Code / Code | <b>774607</b> |
|------------------------------|---------------|

|   |                    |
|---|--------------------|
| <b>POT. MÁXIMA</b><br>Max Power<br>Puissance maximale | 230 V ~ 13A 3.000W |
|---|--------------------|

|                                   |  |
|-----------------------------------|--|
| <b>BASES</b><br>Sockets / Entrées | Base aérea<br>Air base / Base aérienne |
|-----------------------------------|--|

|   |   |
|---|---|
| <b>CONTIENE</b><br>Contained / Contient | Base aérea con termostato<br>Air base thermostat<br>Base aérienne avec thermostat |
|---|---|

|                               |                    |
|-------------------------------|--------------------|
| <b>CABLE</b><br>Cable / Cable | H05VV-F 3G1,5 25 M |
|-------------------------------|--------------------|

|   |        |
|---|--------|
| <b>DIÁMETRO DE CARRETE</b><br>Spool diameter<br>Diamètre de la bobine | 240 mm |
|---|--------|

|   |   |
|---|---|
| <b>EMBALAJE / UNIDADES</b><br>Packing / Units<br>Emballage / Unités | 1 |
|---|---|

|                              |               |               |
|------------------------------|---------------|---------------|
| <b>CÓDIGO</b><br>Code / Code | <b>770500</b> | <b>775505</b> |
|------------------------------|---------------|---------------|

|   |                |                |
|---|----------------|----------------|
| <b>POT. MÁXIMA</b><br>Max Power<br>Puissance maximale | 250 V ~ 3.500W | 250 V ~ 3.500W |
|---|----------------|----------------|

|                                   |   |   |
|-----------------------------------|---|---|
| <b>BASES</b><br>Sockets / Entrées | 4 (2P+T) con termostato<br>4 (2P+T) with thermostat<br>4 (2P+T) avec thermostat | 4 (2P+T) con termostato<br>4 (2P+T) with thermostat<br>4 (2P+T) avec thermostat |
|-----------------------------------|---|---|

|                               |                    |                    |
|-------------------------------|--------------------|--------------------|
| <b>CABLE</b><br>Cable / Cable | H05VV-F 3G1,5 25 M | H05VV-F 3G1,5 50 M |
|-------------------------------|--------------------|--------------------|

|   |        |        |
|---|--------|--------|
| <b>DIÁMETRO DE CARRETE</b><br>Spool diameter<br>Diamètre de la bobine | 255 mm | 255 mm |
|---|--------|--------|

|   |   |   |
|---|---|---|
| <b>EMBALAJE / UNIDADES</b><br>Packing / Units<br>Emballage / Unités | 1 | 1 |
|---|---|---|





# ENROLLACABLES

Cable reels / Enrouleur



\* Colores especiales disponibles en todos los colores RAL bajo pedido. Consultar Special colours available in all RAL colours under request. Please send us your enquiry. Couleurs spéciales disponibles dans toute gamme de coloris RAL, sur demande.



Soporte metálico  
Metal bracket  
Support en métallique

Mod.  
761607



Carrete de plástico  
Plastic spool  
Bobine en plastique



| CÓDIGO<br>Code / Code   | 761607  | 764608  |
|---|---|---|
| <b>POT. MÁXIMA</b><br>Max Power<br>Puissance maximale                 | 230 V ~ 13A 3.000W  | 230 V ~ 13A 3.000W  |
| <b>BASES</b><br>Sockets / Entrées                                     | 4 (2p+t) con termostato con tapa<br>4 (2p+t) with thermostat and cover<br>4 (2p+t) avec thermostat et couvercle | 4 (2p+t) con termostato con tapa<br>4 (2p+t) with thermostat and cover<br>4 (2p+t) avec thermostat et couvercle |
| <b>CABLE</b><br>Cable / Cable   | H05VV-F 3G1,5 25 M  | H05VV-F 3G1,5 50 M  |
| <b>DIÁMETRO DE CARRETE</b><br>Spool diameter<br>Diamètre de la bobine | 270 mm  | 270 mm  |
| <b>EMBALAJE / UNIDADES</b><br>Packing / Units<br>Emballage / Unités   | 1   | 1   |

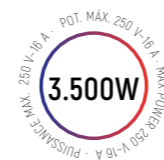

Mod.  
766008



Carrete de plástico  
Plastic spool  
Bobine en plastique

Soporte metálico  
Metal bracket  
Support en métallique

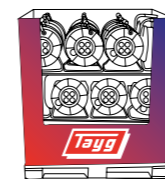
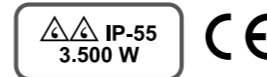

\*OPCIÓN BOX PALLET  
Box - pallet option  
Option palette expo

| CÓDIGO<br>Code / Code   | 765001 / 766008     |
|---|---------------------|
| <b>MEDIDAS BOX-PALET</b><br>box-palet sizes<br>Mesures palette expo | 1122 x 805 x 1160mm |



\* Colores especiales disponibles en todos los colores RAL bajo pedido. Consultar Special colours available in all RAL colours under request. Please send us your enquiry. Couleurs spéciales disponibles dans toute gamme de coloris RAL, sur demande.

| CÓDIGO<br>Code / Code   | 765001  | 766008  |
|---|---|---|
| <b>POT. MÁXIMA</b><br>Max Power<br>Puissance maximale                 | 250 V ~ 3.500W  | 250 V ~ 3.500W  |
| <b>BASES</b><br>Sockets / Entrées                                     | 3 (2P+T) con termostato y tapa<br>3 (2P+T) with thermostat and cover<br>3 (2P+T) avec thermostat et couvercle | 3 (2P+T) con termostato y tapa<br>3 (2P+T) with thermostat and cover<br>3 (2P+T) avec thermostat et couvercle |
| <b>CABLE</b><br>Cable / Cable   | H05VV-F 3G1,5 25 M  | H05VV-F 3G1,5 50 M  |
| <b>DIÁMETRO DE CARRETE</b><br>Spool diameter<br>Diamètre de la bobine | 290 mm  | 290 mm  |
| <b>EMBALAJE / UNIDADES</b><br>Packing / Units<br>Emballage / Unités   | 1   | 1   |



## ENROLLACABLES

Cable reels / Enrouleur

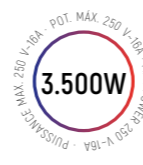

| CÓDIGO<br>Code / Code   | 785009  | 786006  |
|---|---|---|
| <b>POT. MÁXIMA</b><br>Max Power<br>Puissance maximale                     | 250 V ~ 4.000W  | 250 V ~ 4.000W  |
| <b>BASES</b><br>Sockets / Entrées   | 3 (2P+T) con termostato y tapa<br>3 (2P+T) with thermostat<br>and cover<br>3 (2P+T) avec thermostat et<br>couvercle | 3 (2P+T) con termostato y tapa<br>3 (2P+T) with thermostat<br>and cover<br>3 (2P+T) avec thermostat et<br>couvercle |
| <b>CABLE</b><br>Cable / Cable   | H05VV-F 3G2,5 25 M  | H05VV-F 3G2,5 50 M  |
| <b>DIÁMETRO DE<br/>CARRETE</b><br>Spool diameter<br>Diamètre de la bobine | 255 mm  | 310 mm  |
| <b>EMBALAJE /<br/>UNIDADES</b><br>Packing / Units<br>Emballage / Unités   | 1   | 1   |

Enrollacable con aplique francés  
Cable reel with french connection  
Enrouleur avec prise français



| CÓDIGO<br>Code / Code   | 785511  | 786518  | 785528  | 786525  |
|---|---|---|---|---|
| <b>POT. MÁXIMA</b><br>Max Power<br>Puissance maximale                     | 250 V ~ 4.000W  | 250 V ~ 4.000W  | 250 V ~ 4.000W  | 250 V ~ 4.000W  |
| <b>BASES</b><br>Sockets / Entrées   | 3 (2P+T) con termostato y tapa<br>3 (2P+T) with thermostat<br>and cover<br>3 (2P+T) avec thermostat et<br>couvercle | 3 (2P+T) con termostato y tapa<br>3 (2P+T) with thermostat<br>and cover<br>3 (2P+T) avec thermostat et<br>couvercle | 3 (2P+T) con termostato y tapa<br>3 (2P+T) with thermostat<br>and cover<br>3 (2P+T) avec thermostat et<br>couvercle | 3 (2P+T) con termostato y tapa<br>3 (2P+T) with thermostat<br>and cover<br>3 (2P+T) avec thermostat et<br>couvercle |
| <b>CABLE</b><br>Cable / Cable   | H05VV-F 3G2,5 25 M  | H05VV-F 3G2,5 50 M  | H05VV-F 3G2,5 25 M  | H05VV-F 3G2,5 50 M  |
| <b>DIÁMETRO DE<br/>CARRETE</b><br>Spool diameter<br>Diamètre de la bobine | 255 mm  | 310 mm  | 255 mm  | 310 mm  |
| <b>EMBALAJE /<br/>UNIDADES</b><br>Packing / Units<br>Emballage / Unités   | 1   | 1   | 1   | 1   |

\* Cod. 785511 y 786518. Países homologados para uso. El aplique español: Spanish connection: / Prise espagnol: Holanda, Luxemburgo, Austria, Croacia, Suiza, Portugal, Lituania, Grecia, Chipre, Albania, Andorra, Rusia, Bielorusia, Bosnia, Bulgaria, Republica Checa, Estonia, Islas Feroe, Finlandia, Alemania, Hungría, Islandia, Lituania, Letonia, Macedonia, Mónaco, Noruega, Rumania, Eslovenia, Ucrania, Serbia, Montenegro. El aplique francés: French connection: / Prise français: Bélgica, Eslovaquia y Túnez.

Mod.  
765506

Soporte y carrete metálico  
Metal spool and metal frame  
Support et bobine en métallique

Cable goma neopreno exteriores  
Cable rubber neoprene outdoor  
Cable extérieur en caoutchouc neoprene

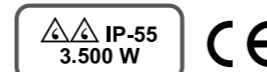

| CÓDIGO<br>Code / Code   | 765506   | 766503   | 795503   |
|---|--|--|--|
| <b>POT. MÁXIMA</b><br>Max Power<br>Puissance maximale                     | 250 V ~ 3.500W   | 250 V ~ 3.500W   | 250 V ~ 4.000W   |
| <b>BASES</b><br>Sockets / Entrées   | 3 (2P+T)<br>con termostato y tapa<br>with thermostat and cover<br>avec thermostat et couvercle | 3 (2P+T)<br>con termostato y tapa<br>with thermostat and cover<br>avec thermostat et couvercle | 3 (2P+T)<br>con termostato y tapa<br>with thermostat and cover<br>avec thermostat et couvercle |
| <b>CABLE</b><br>Cable / Cable   | H07RN-F 3G1,5 25 m<br>Goma/Neopreno<br>Rubber/Neoprene<br>Caoutchouc/néoprène                  | H07RN-F 3G1,5 50 m<br>Goma/Neopreno<br>Rubber/Neoprene<br>Caoutchouc/néoprène                  | H07RN-F 3G2,5 25 m<br>Goma/Neopreno<br>Rubber/Neoprene<br>Caoutchouc/néoprène                  |
| <b>DIÁMETRO DE<br/>CARRETE</b><br>Spool diameter<br>Diamètre de la bobine | 255 mm   | 310 mm   | 255 mm   |
| <b>EMBALAJE /<br/>UNIDADES</b><br>Packing / Units<br>Emballage / Unités   | 1  | 1  | 1  |

\*Para instaladores eléctricos: cumple con la instrucción técnica complementaria n°33 del reglamento de baja tensión.  
For electrical installers: Comply with Complementary Technical Instruction no 33 of the Spanish Low Voltage Electrical Installation Regulations.  
Pour les installateurs électriques: Conforme avec la norme technique n°33 du règlement de basse tension espagnol



## ENROLLACABLES

Cable reels / Enrouleur

\*Para instaladores eléctricos: cumple con la instrucción técnica complementaria n°33 del reglamento de baja tensión.  
For electrical installers: Comply with Complementary Technical Instruction n° 33 of the Spanish Low Voltage Electrical Installation Regulations.  
Pour les installateurs électriques: Conforme avec la norme technique n°33 du règlement de basse tension espagnol



Mod.  
767500

Soporte metálico  
Metal bracket  
Support en métallique

Carrete metálico  
Metal spool  
Bobine en métallique

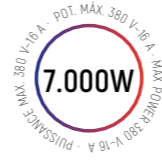
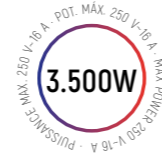

\*TRIFÁSICOS  
Three phase  
Triphasé



Mod.  
780516

Soporte y carrete metálico  
Metal spool and metal frame  
Support et bobine en métallique

| CÓDIGO<br>Code / Code   | 767500  | 768507  |
|---|---|---|
| <b>POT. MÁXIMA</b><br>Max Power<br>Puissance maximale                 | 250 V ~ 3.500W  | 250 V ~ 3.500W  |
| <b>BASES</b><br>Sockets / Entrées                                     | 2 (2P+T) con termostato y tapa<br>2 (2P+T) with thermostat and cover<br>2 (2P+T) avec thermostat et couvercle | 2 (2P+T) con termostato y tapa<br>2 (2P+T) with thermostat and cover<br>2 (2P+T) avec thermostat et couvercle |
| <b>CABLE</b><br>Cable / Cable   | H07RN-F 3G1,5 25 m<br>Goma/Neopreno<br>Rubber/Neoprene<br>Caoutchouc/néoprène                                 | H07RN-F 3G1,5 50 m<br>Goma/Neopreno<br>Rubber/Neoprene<br>Caoutchouc/néoprène                                 |
| <b>DIÁMETRO DE CARRETE</b><br>Spool diameter<br>Diamètre de la bobine | 255 mm  | 310 mm  |
| <b>EMBALAJE / UNIDADES</b><br>Packing / Units<br>Emballage / Unités   | 1   | 1   |

| CÓDIGO<br>Code / Code   | 760518  | 780516  |
|---|---|---|
| <b>POT. MÁXIMA</b><br>Max Power<br>Puissance maximale                 | 380 V ~ 7.000W  | 380 V ~ 7.000W  |
| <b>BASES</b><br>Sockets / Entrées                                     | 2 (3P+T6h 380V)<br>con termostato y tapa<br>with thermostat and cover<br>avec thermostat et couvercle | 2 (3P+T6h 380V)<br>con termostato y tapa<br>with thermostat and cover<br>avec thermostat et couvercle |
| <b>CABLE</b><br>Cable / Cable   | H05VV-F 4G1,5 25 m  | H05VV-F 4G1,5 40 m  |
| <b>DIÁMETRO DE CARRETE</b><br>Spool diameter<br>Diamètre de la bobine | 255 mm  | 310 mm  |
| <b>EMBALAJE / UNIDADES</b><br>Packing / Units<br>Emballage / Unités   | 1   | 1   |

# ACCESORIOS PARA LA CONSTRUCCIÓN

Building accessories | Accessoires pour la construction | Bauzubehör

# 07



## **DISTANCIADORES PAVIMENTO Y SISTEMAS DE NIVELACIÓN 118**

Wall and floor spacers  
Espaceurs sol et mur  
Fliesenabstandshalter und Nivelliersysteme



## **SOPORTE PAVIMENTO FLOTANTE 126**

Plots  
Support de sol flottant  
Stelzlager Höhenverstellbar



## **FACHADA, PAVÉS Y ACCESORIOS DE SEGURIDAD 134**

Safety brackets | Safety accessories  
Glass block spacer | Accessoires de sécurité  
Fassaden- und Sicherheitszubehör



## **ACCESORIOS PARA ENCOFRADO 140**

Formwork accessories  
Accessoires pour coffrage  
Zubehör für Schalungen

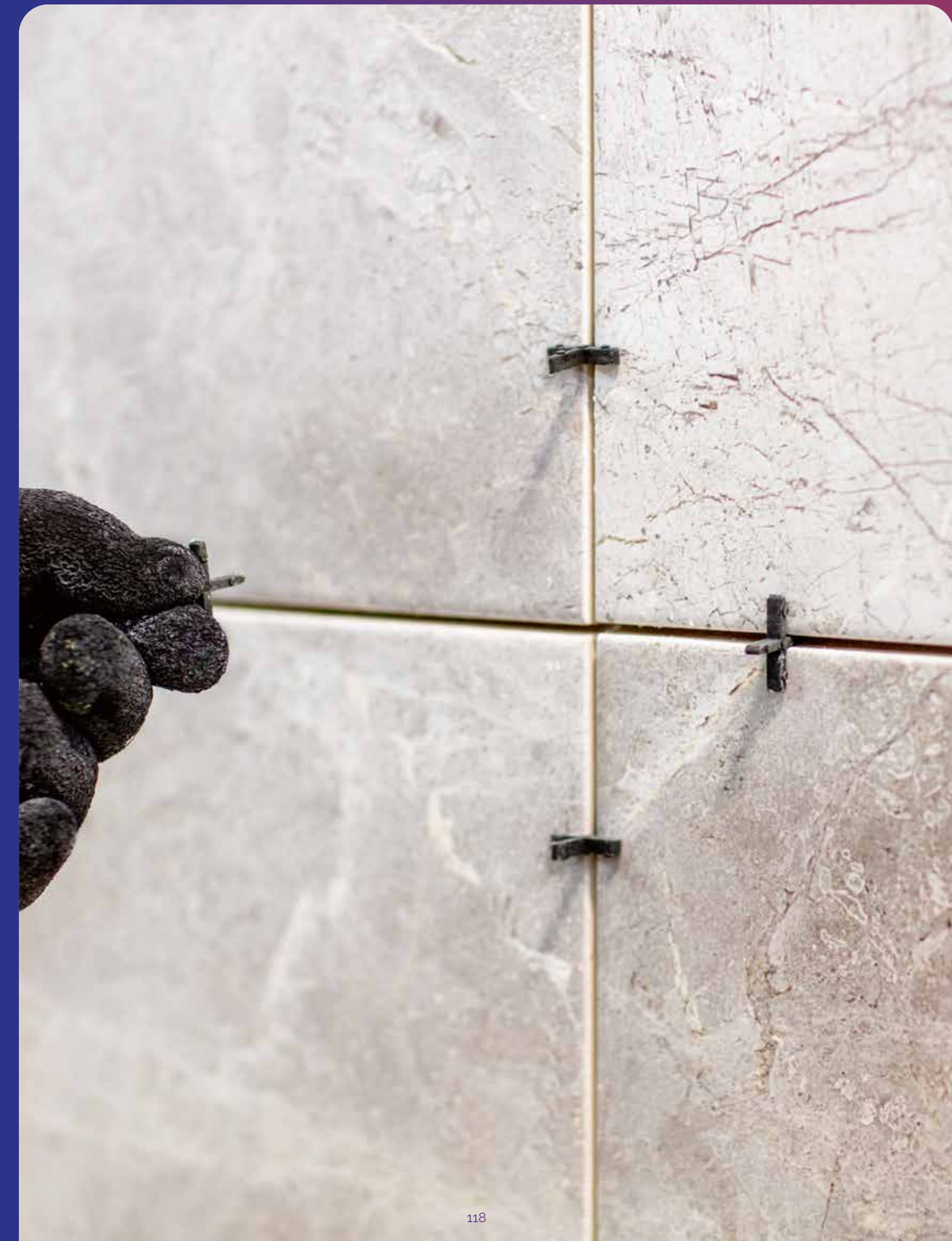

# DISTANCIADORES PAVIMENTO Y REVESTIMIENTO

Wall and floor spacers  
Espaceurs sol et mur

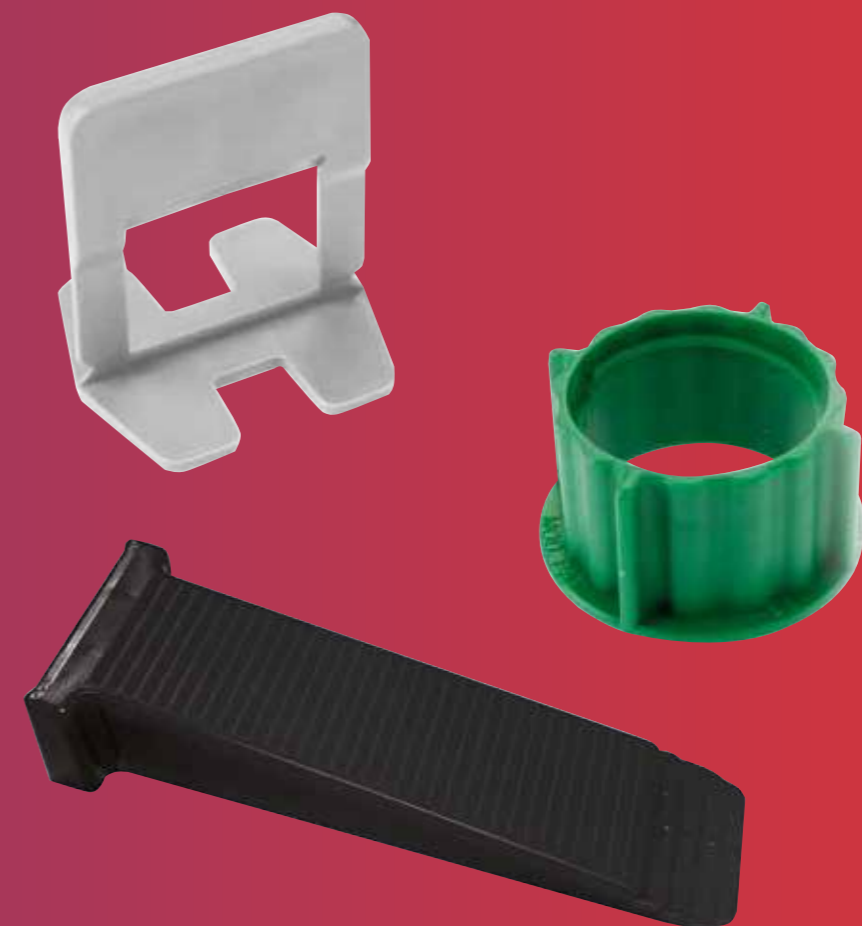



# CRUCETAS

Tile spacer / Croisillons



Grandes formatos  
Big sizes  
Grand formats



Alta resistencia  
High strength  
Haute resistance



\*CRUCETAS EXPOSITOR  
Présentoir des produits  
Tile spacer exhibitor



Modo de uso  
Mode of use  
Mode d'utilisation

Diseñadas para grandes formatos y de gran peso  
Designed for big sizes and heavy weights  
Dessinées pour des grands formats lourds



Cuña alicatado  
Tile wedge  
Câle pour pose

|  |               |
|--|---------------|
| <b>MODELO</b><br>Model / Modèle                  |               |
| <b>CÓDIGO</b><br>Code / Code                     | <b>912009</b> |
| <b>MEDIDAS</b><br>Sizes / Mesures                | 1-5 mm        |
| <b>UDS. BOLSA</b><br>Units bag<br>Unités sac     | 300           |
| <b>UDS. CAJA</b><br>Units pack<br>Unités pack    | 30.000        |
| <b>CAJAS PALET</b><br>Pack pallet<br>Pack pallet | 30            |



| CÓDIGO<br>Code / Code                            | 910005       | 910012         | 910029       | 910036      | 910050        | 910067       | 910074         | 910081         |
|--|--------------|----------------|--------------|-------------|---------------|--------------|----------------|----------------|
| <b>MEDIDAS</b><br>Sizes / Mesures                | 1 mm - 3/64" | 1.5 mm - 1/16" | 2 mm - 5/64" | 3 mm - 1/8" | 5 mm - 13/64" | 7 mm - 9/32" | 10 mm - 13/32" | 15 mm - 19/32" |
| <b>UDS. BOLSA</b><br>Units bag<br>Unités sac     | 500          | 500            | 500          | 500         | 300           | 300          | 100            | 100            |
| <b>UDS. CAJA</b><br>Units pack<br>Unités pack    | 30.000       | 30.000         | 30.000       | 30.000      | 13.500        | 6.000        | 3.000          | 1.200          |
| <b>CAJAS PALET</b><br>Pack pallet<br>Pack pallet | 30           | 30             | 20           | 20          | 20            | 20           | 20             | 42             |

# KIT SISTEMA DE NIVELACIÓN

Levelling system kit / Kit système de nivellement

**PROFESIONAL**

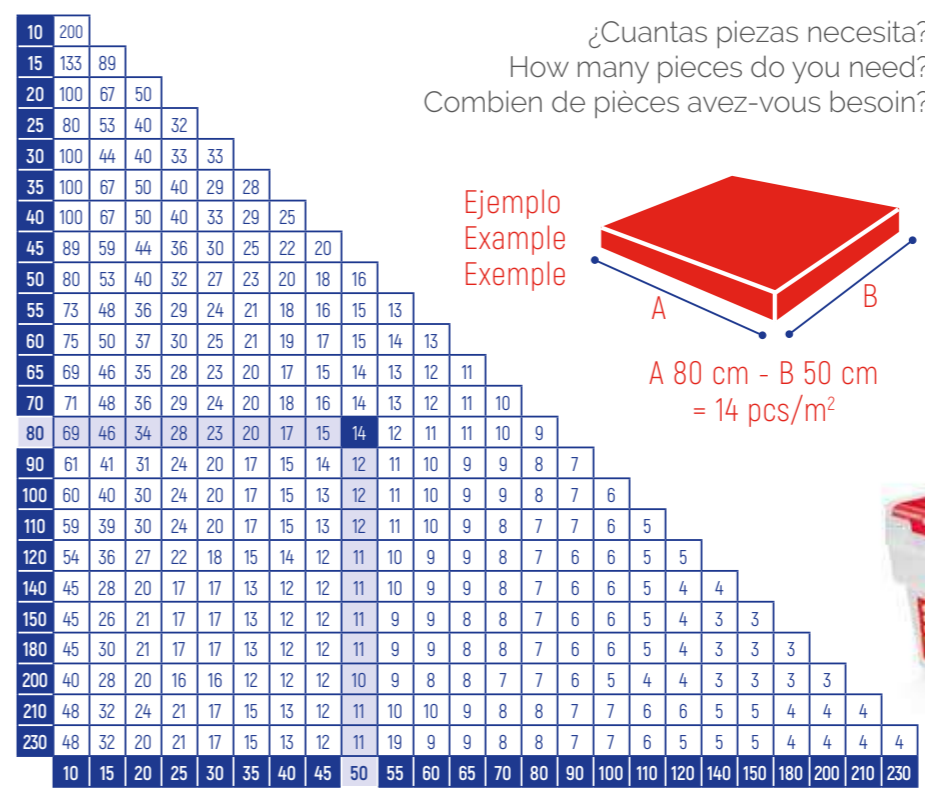

| MODELO<br>Model<br>Modèle                | Kit sistema de nivelación con<br>cuña milimetrada ancha 1/1,5/2 mm<br>Professional levelling system kit with<br>millimetrated wide wedge 1/1,5/2 mm<br>Kit système de nivellement<br>professionnelle<br>avec cale large millimètre 1/1,5/2 mm | Kit sistema nivel baldosas cuña ancha<br>1/1,5 mm<br>Levelling system wide wedge 1/1,5 mm<br>Kit système de nivellement cale large<br>1/1,5 mm | Kit sistema profesional nivel baldosas<br>cuña ancha 1/1,5/2 mm<br>Levelling system wide wedge 1/1,5/2 mm<br>Kit système de nivellement cale large<br>1/1,5/2 mm |
|--|---|--|--|
| <b>CÓDIGO</b><br>Code / Code             | <b>913747 / 913754 / 913761</b>   | <b>913648 / 913655</b>   | <b>913662 / 913679 / 913686</b>  |
| <b>CONTIENE</b><br>Contained<br>Contient | 100 Bases, 100 Cuñas milimetradas<br>100 Base, 100 Millimetrated wedges,<br>100 Brides, 100 Câle millimètre   | 100 Bases, 100 Cuñas,<br>1 Alicata plástico<br>100 Base, 100 Wedges,<br>1 Plastic pliers<br>100 Brides, 100 Câle,<br>1 Tenaille en plastique   | 100 Bases, 100 Cuñas,<br>1 Alicata metálico<br>100 Base, 100 Wedges,<br>1 Metallic pliers<br>100 Brides, 100 Câle,<br>1 Tenaille en métallique                   |

Tayg Build  
Tayg Build  
Tayg Build  
Tayg Light  
Tayg Light  
Tayg Light  
Eco Tayg  
Eco Tayg  
Eco Tayg  
Caja de herramientas y estuches  
Tool boxes and organizers  
Boîtes à outils et coffrets  
Productos de ordenación  
Arrangement products  
Produits de rangement  
Colección hogar  
Home collection  
Boîtes de rangement Home

Lista de packing  
Packing list  
Liste d'emballage



# SISTEMA DE NIVELACIÓN

Levelling system / Système de nivellement



Mod.  
H: 3-12 mm

Base nivelación  
Levelling base  
Bride nivellement



Modo de uso  
Mode of use  
Mode d'utilisation

## H: 3-12 MM BASE NIVELACIÓN

Levelling base / Bride nivellement



NOVEDAD  
NEW / NOUVEAUTÉ

| MEDIDAS<br>Sizes/ Mesures                        | Base 1 mm - 3/64" |        |        | Base 1,5 mm - 1/16" |        |        | Base 2 mm - 5/64" |        |        | Base 3 mm - 1/8" |        |        |
|--|-------------------|--------|--------|---------------------|--------|--------|-------------------|--------|--------|------------------|--------|--------|
| <b>CÓDIGO</b><br>Code / Code                     | 913006            | 913013 | 913020 | 913914              | 913921 | 913938 | 913037            | 913044 | 913051 | 913068           | 913075 | 913082 |
| <b>UDS. BOLSA</b><br>Units bag<br>Unités sac     | 100               | 250    | 500    | 100                 | 250    | 500    | 100               | 250    | 500    | 100              | 250    | 500    |
| <b>UDS. CAJA</b><br>Units pack<br>Unités pack    | 3000              | 3000   | 3000   | 3000                | 3000   | 3000   | 3000              | 3000   | 3000   | 3000             | 3000   | 3000   |
| <b>CAJAS PALET</b><br>Pack pallet<br>Pack pallet | 20                | 20     | 20     | 20                  | 20     | 20     | 20                | 20     | 20     | 20               | 20     | 20     |

## H: 16-22 MM BASE ALTA (MÁRMOL / PIEDRA)

High base / Haute bride



Mod.  
H: 16-22 mm

Base alta (Mármol / Piedra)  
High base / Haute bride

| MEDIDAS<br>Sizes/ Mesures                        | Base 1 mm - 3/64" |        |        | Base 2 mm - 5/64" |        |        |
|--|-------------------|--------|--------|-------------------|--------|--------|
| <b>CÓDIGO</b><br>Code / Code                     | 913334            | 913341 | 913358 | 913365            | 913372 | 913389 |
| <b>UDS. BOLSA</b><br>Units bag<br>Unités sac     | 100               | 250    | 500    | 100               | 250    | 500    |
| <b>UDS. CAJA</b><br>Units pack<br>Unités pack    | 3000              | 3000   | 3000   | 3000              | 3000   | 3000   |
| <b>CAJAS PALET</b><br>Pack pallet<br>Pack pallet | 16                | 16     | 16     | 16                | 16     | 16     |



Mod.  
H: 3-14 mm

Base slim compatible con rosca (estrecha)  
Slim base compatible with levelling thread  
Slim bride compatible avec fil de nivellement

NOVEDAD  
NEW / NOUVEAUTÉ

Cabeza dentada para uso con rosca  
Serrated head for use with thread  
Tête dentelée a utiliser avec écrou



## H: 3-14 MM BASE COMPATIBLE CON ROSCA

Base compatible with levelling thread / Bride compatible avec fil de nivellement

| MEDIDAS<br>Sizes<br>Mesures                      | Base 0,5 mm<br>V - 1/51" |        | Base 1 mm - 3/64" |        | Base 1,5 mm - 1/16" |        | Base 2 mm - 5/64" |        | Base 3 mm - 1/8" |        |        |        |        |        |        |
|--|--------------------------|--------|-------------------|--------|---------------------|--------|-------------------|--------|------------------|--------|--------|--------|--------|--------|--------|
| <b>CÓDIGO</b><br>Code<br>Code                    | 913549                   | 913556 | 913563            | 913211 | 913228              | 913235 | 913242            | 913259 | 913266           | 913273 | 913280 | 913297 | 913303 | 913310 | 913327 |
| <b>UDS. BOLSA</b><br>Units bag<br>Unités sac     | 100                      | 250    | 500               | 100    | 250                 | 500    | 100               | 250    | 500              | 100    | 250    | 500    | 100    | 250    | 500    |
| <b>UDS. CAJA</b><br>Units pack<br>Unités pack    | 3000                     | 3000   | 3000              | 3000   | 3000                | 3000   | 3000              | 3000   | 3000             | 3000   | 3000   | 3000   | 3000   | 3000   | 3000   |
| <b>CAJAS PALET</b><br>Pack pallet<br>Pack pallet | 16                       | 16     | 16                | 16     | 16                  | 16     | 16                | 16     | 16               | 16     | 16     | 16     | 16     | 16     | 16     |

## H: 3-14 MM BASE SLIM COMPATIBLE CON ROSCA (ESTRECHA)

Slim base compatible with levelling thread / Slim bride compatible avec fil de nivellement

| MEDIDAS<br>Sizes<br>Mesures                      | Base 0,5 mm<br>V - 1/51" |        | Base 1 mm - 3/64" |        | Base 1,5 mm - 1/16" |        | Base 2 mm - 5/64" |        | Base 3 mm - 1/8" |        |        |        |        |        |        |
|--|--------------------------|--------|-------------------|--------|---------------------|--------|-------------------|--------|------------------|--------|--------|--------|--------|--------|--------|
| <b>CÓDIGO</b><br>Code<br>Code                    | 913518                   | 913525 | 913532            | 913099 | 913105              | 913112 | 913129            | 913136 | 913143           | 913150 | 913167 | 913174 | 913181 | 913198 | 913204 |
| <b>UDS. BOLSA</b><br>Units bag<br>Unités sac     | 100                      | 250    | 500               | 100    | 250                 | 500    | 100               | 250    | 500              | 100    | 250    | 500    | 100    | 250    | 500    |
| <b>UDS. CAJA</b><br>Units pack<br>Unités pack    | 3000                     | 3000   | 3000              | 3000   | 3000                | 3000   | 3000              | 3000   | 3000             | 3000   | 3000   | 3000   | 3000   | 3000   | 3000   |
| <b>CAJAS PALET</b><br>Pack pallet<br>Pack pallet | 16                       | 16     | 16                | 16     | 16                  | 16     | 16                | 16     | 16               | 16     | 16     | 16     | 16     | 16     | 16     |

Cajas de herramientas y estuches  
Tool boxes and organizers  
Boîtes à outils et coffrets

Productos de ordenación  
Arrangement products  
Produits de rangement

Colección hogar  
Home collection  
Boîtes de rangement Home

Eco Tayg  
Eco Tayg  
Eco Tayg

Tayg Light  
Tayg Light  
Tayg light

Tayg Build  
Tayg Build  
Tayg Build

Lista de packing  
Packing list  
Liste d'emballage



# ACCESORIOS DE NIVELACIÓN

Levelling system / Accessoires de mise à niveau



Mod. 913495

Rosca de nivelación. Fácil y de uso muy sencillo, pensado para ahorrar costes y tiempo. Reutilizable. Rotura perfecta y limpia, sin necesidad del uso de cuñas.

The levelling thread is a new system patented by Tayg Build, in which, we are looking for the easier and quicker installation of the tile bases, through the manual adjust by screwing, ensuring the levelling and getting the correct planimetry on the installation.

Fil de nivellement. C'est un nouveau système breveté par Tayg Build, avec lui, on recherche une installation plus commode est rapide de la céramique à Travers l'ajustement Manuel vissé qui assure le nivellement et la parfaite planimétrie de la pose.



Mod. 913587

Cuña profesional milimetrada. Apta para colocación manual. Professional measuring tip. Suitable for manual installation. Cône professionnel milimétré. Approprié pour la pose manuelle.

Modo de uso  
Mode of use  
Mode d'utilisation

## MODO DE USO Comment utiliser / Mode of use

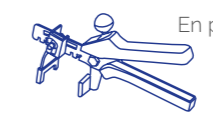

En primer lugar limpiar la superficie para una correcta colocación, además de ajustar el alicate según el espesor del material. First clean the surface for correct placement, furthermore adjust the pliers according to the thickness. Commencez par nettoyer la surface pour une pose correcte, ajuster la pince selon l'épaisseur du carrelage.



Rosca Thread Écrou



Alicate metálico\* (profesional) Plastic plier Pince métallique



Alicate plástico\* Metálic plier Pince plastique

MODELO  
Model / Modèle

| CÓDIGO<br>Code / Code                     | 913495 | 913501 | 913471 | 913488 |
|---|--------|--------|--------|--------|
| UDS. BOLSA<br>Units bag / Unités sac      | 50     | 100    | 1      | 1      |
| UDS. CAJA<br>Units pack<br>Unités pack    | 1200   | 1200   | 6      | 6      |
| CAJAS PALET<br>Pack pallet<br>Pack pallet | 16     | 16     | 96     | 96     |

\* Los alicates son compatibles tanto para base estrecha como para base ancha. The pliers are able to use it with wide base or slim base. Les pinces sont compatibles pour les bases étroites comme pour les bases larges.



Cuña slim (estrecha) 13 mm SLIM wedge (slim) 13 mm Cale SLIM (étroite) 13 mm



Cuña profesional milimetrada 22mm Professional measuring wedge 22mm Cale professionnelle milimétrée 22mm

MODELO  
Model / Modèle

| CÓDIGO<br>Code / Code                     | 913396 | 913402 | 913419 | 913570 | 913587 | 913594 |
|---|--------|--------|--------|--------|--------|--------|
| UDS. BOLSA<br>Units bag / Unités sac      | 100    | 250    | 500    | 100    | 250    | 500    |
| UDS. CAJA<br>Units pack<br>Unités pack    | 2000   | 2000   | 2000   | 2000   | 2000   | 2000   |
| CAJAS PALET<br>Pack pallet<br>Pack pallet | 16     | 16     | 16     | 16     | 16     | 16     |



1 Colocar bases / Placer les bases / Place the base

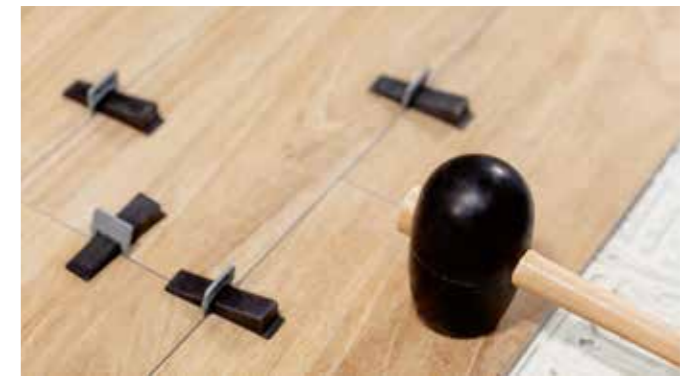

2 Macear ligeramente / Taper légèrement / Tap gently



3 Introducir cuñas / Introduire les câles / Introduce the wedges



4 Apretar / Serer / Tighten

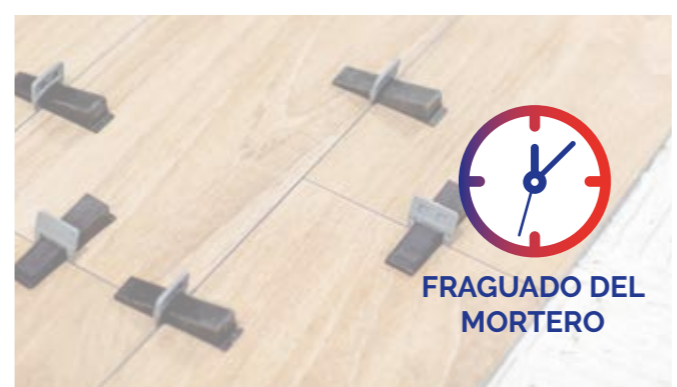

5 Esperar secado / Attendre que cela sèche / Allow for setting



6 Retirar sistema / Retier le système / Remove the system





# SOPORTE PAVIMENTO FLOTANTE

Plots  
Support de sol flottant





# SOPORTE PAVIMENTO FLOTANTE

Plots / Support de sol flottant

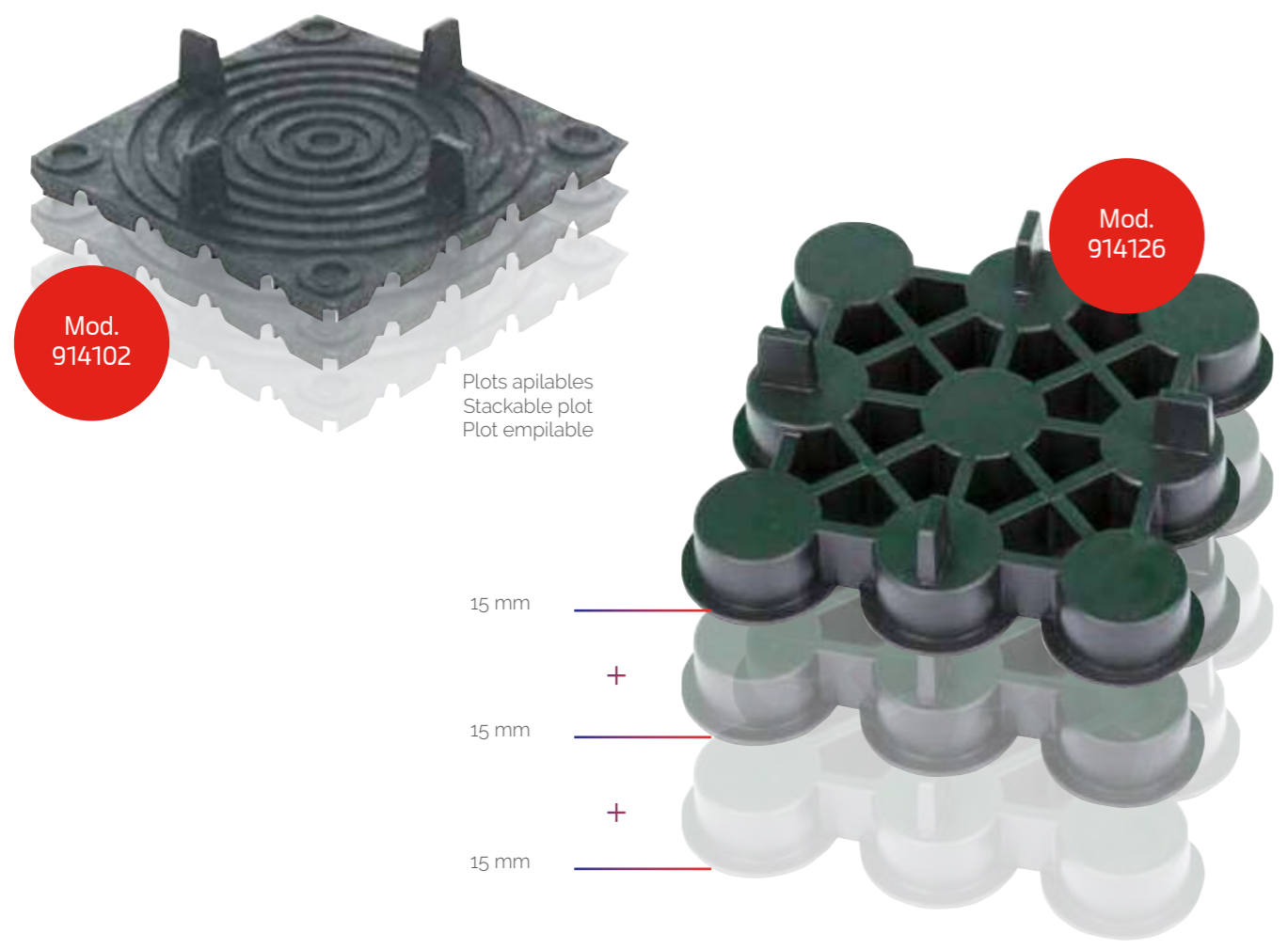

**Modo de uso**  
**Mode of use**  
**Mode d'utilisation**



Indicador de bajante  
Downspout indicator  
Indicateur de descente

Diferentes modelos. Desniveles: 0%, 1%, 2% para aportar inclinación y facilitar el drenaje del agua.  
Different models. Unevenness: 0%, 1%, 2% to give inclination and allow water drainage. Différents modèles.  
Différents modèles. Denivelés : 0%, 1%, 2% pour apporter une inclinaison et faciliter la drainage de l'eau.

## TB 750



## SOPORTE REGULABLE PAVIMENTO FLOTANTE

Support réglable de sol flottant / Plot



|  |           |           |           |
|--|-----------|-----------|-----------|
| <b>DESNIVEL</b><br>Unevenness<br>Denivelés | <b>1%</b> | <b>1%</b> | <b>1%</b> |
|--|-----------|-----------|-----------|

|                              |               |               |               |
|------------------------------|---------------|---------------|---------------|
| <b>CÓDIGO</b><br>Code / Code | <b>914140</b> | <b>914003</b> | <b>914010</b> |
|------------------------------|---------------|---------------|---------------|

|                                   |          |          |          |
|-----------------------------------|----------|----------|----------|
| <b>MEDIDAS</b><br>Sizes / Mesures | 25-35 mm | 35-50 mm | 50-70 mm |
|-----------------------------------|----------|----------|----------|

|   |     |     |     |
|---|-----|-----|-----|
| <b>UDS. CAJA</b><br>Units pack<br>Unités pack | 100 | 100 | 130 |
|---|-----|-----|-----|

|  |    |    |    |
|--|----|----|----|
| <b>CAJAS PALET</b><br>Pack pallet<br>Pack pallet | 20 | 20 | 16 |
|--|----|----|----|

\* Para desniveles de 0% o 2% consultar con fábrica.  
For unevenness of 0% or 2% ask your commercial agent.  
Pour des inégalités de 0% ou 2%, demandez à votre agent commercial.

## SOPORTE PAVIMENTO FLOTANTE NO REGULABLE

Not adjustable plot / Support de sol flottant non réglable



| CÓDIGO<br>Code / Code                            | 914102 | 914126 | 914133 |
|--|--------|--------|--------|
| <b>MEDIDAS</b><br>Sizes / Mesures                | 10 mm  | 15 mm  | 20 mm  |
| <b>ALETA</b><br>Aile / Wing                      | 3 mm   | 3 mm   | 3 mm   |
| <b>UDS. CAJA</b><br>Units pack<br>Unités pack    | 280    | 280    | 120    |
| <b>CAJAS PALET</b><br>Pack pallet<br>Pack pallet | 20     | 20     | 20     |

\* Base amortiguadora recomendada Ref. 914119  
Recommended Damper base Ref. 914119 / Base amortissante recommandée Ref. 914119

Cajas de herramientas y estuches  
Tool boxes and organizers  
Boîtes à outils et coffres

Productos de ordenación  
Arrangement products  
Produits de rangement

Colección hogar  
Home collection  
Boîtes de rangement Home

Eco Tayg  
Eco Tayg  
Eco Tayg

Tayg Light  
Tayg Light  
Tayg light

Tayg Build  
Tayg Build  
Tayg Build

Lista de packing  
Packing list  
Liste d'emballage



# SOPORTE PAVIMENTO FLOTANTE

Plots / Support de sol flottant



Indicador de bajante  
Downspout indicator  
Indicateur de descente



65 - 100 mm  
100 - 130 mm

## TB 1000



**DESNIVEL**  
Unevenness  
Denivelés

1,5%      1,5%

|                              |               |               |
|------------------------------|---------------|---------------|
| <b>CÓDIGO</b><br>Code / Code | <b>914027</b> | <b>914034</b> |
|------------------------------|---------------|---------------|

|                                   |           |            |
|-----------------------------------|-----------|------------|
| <b>MEDIDAS</b><br>Sizes / Mesures | 65-100 mm | 100-130 mm |
|-----------------------------------|-----------|------------|

|   |    |    |
|---|----|----|
| <b>UDS. CAJA</b><br>Units pack<br>Unités pack | 75 | 65 |
|---|----|----|

|  |    |    |
|--|----|----|
| <b>CAJAS PALET</b><br>Pack pallet<br>Pack pallet | 16 | 16 |
|--|----|----|

\* Para desniveles de 0% o 2% consultar con fábrica.  
For unevenness of 0% or 2% ask your commercial agent  
Pour des inégalités de 0% ou 2%, demandez à votre agent commercial.

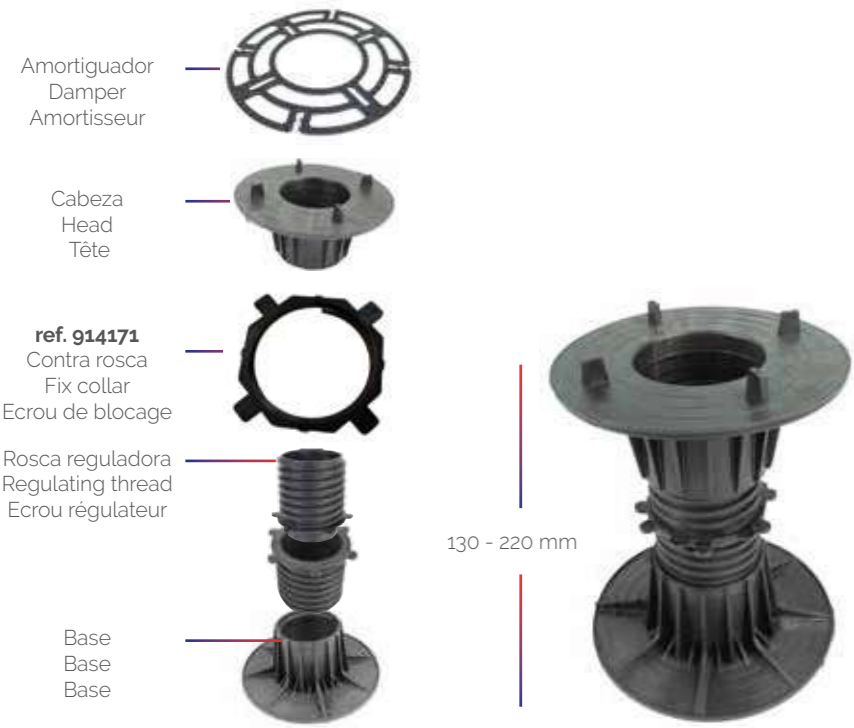

**DESNIVEL**  
Unevenness  
Denivelés

1%

|                              |               |
|------------------------------|---------------|
| <b>CÓDIGO</b><br>Code / Code | <b>914041</b> |
|------------------------------|---------------|

|                                   |            |
|-----------------------------------|------------|
| <b>MEDIDAS</b><br>Sizes / Mesures | 130-220 mm |
|-----------------------------------|------------|

|   |    |
|---|----|
| <b>UDS. CAJA</b><br>Units pack<br>Unités pack | 45 |
|---|----|

|  |    |
|--|----|
| <b>CAJAS PALET</b><br>Pack pallet<br>Pack pallet | 16 |
|--|----|

\* Para desniveles de 0% o 2% consultar con fábrica.  
For unevenness of 0% or 2% ask your commercial agent.  
Pour des inégalités de 0% ou 2%, demandez à votre agent commercial.



**DESNIVEL**  
Unevenness  
Denivelés

1%      1%      1%

|                              |               |               |               |
|------------------------------|---------------|---------------|---------------|
| <b>CÓDIGO</b><br>Code / Code | <b>914072</b> | <b>914089</b> | <b>914096</b> |
|------------------------------|---------------|---------------|---------------|

|                                   |            |            |            |
|-----------------------------------|------------|------------|------------|
| <b>MEDIDAS</b><br>Sizes / Mesures | 400-490 mm | 490-580 mm | 580-670 mm |
|-----------------------------------|------------|------------|------------|

|   |    |    |    |
|---|----|----|----|
| <b>UDS. CAJA</b><br>Units pack<br>Unités pack | 30 | 25 | 25 |
|---|----|----|----|

|  |    |    |    |
|--|----|----|----|
| <b>CAJAS PALET</b><br>Pack pallet<br>Pack pallet | 16 | 16 | 16 |
|--|----|----|----|

\* Para desniveles de 0% o 2% consultar con fábrica. For unevenness of 0% or 2% ask your commercial agent. Pour des inégalités de 0% ou 2%, demandez à votre agent commercial.

|  |               |               |
|--|---------------|---------------|
| <b>DESNIVEL</b><br>Unevenness<br>Denivelés       | 1%            | 1%            |
| <b>CÓDIGO</b><br>Code / Code                     | <b>914058</b> | <b>914065</b> |
| <b>MEDIDAS</b><br>Sizes / Mesures                | 220-310 mm    | 310-400 mm    |
| <b>UDS. CAJA</b><br>Units pack<br>Unités pack    | 35            | 30            |
| <b>CAJAS PALET</b><br>Pack pallet<br>Pack pallet | 16            | 16            |

\* Para desniveles de 0% o 2% consultar con fábrica. For unevenness of 0% or 2% ask your commercial agent. Pour des inégalités de 0% ou 2%, demandez à votre agent commercial.

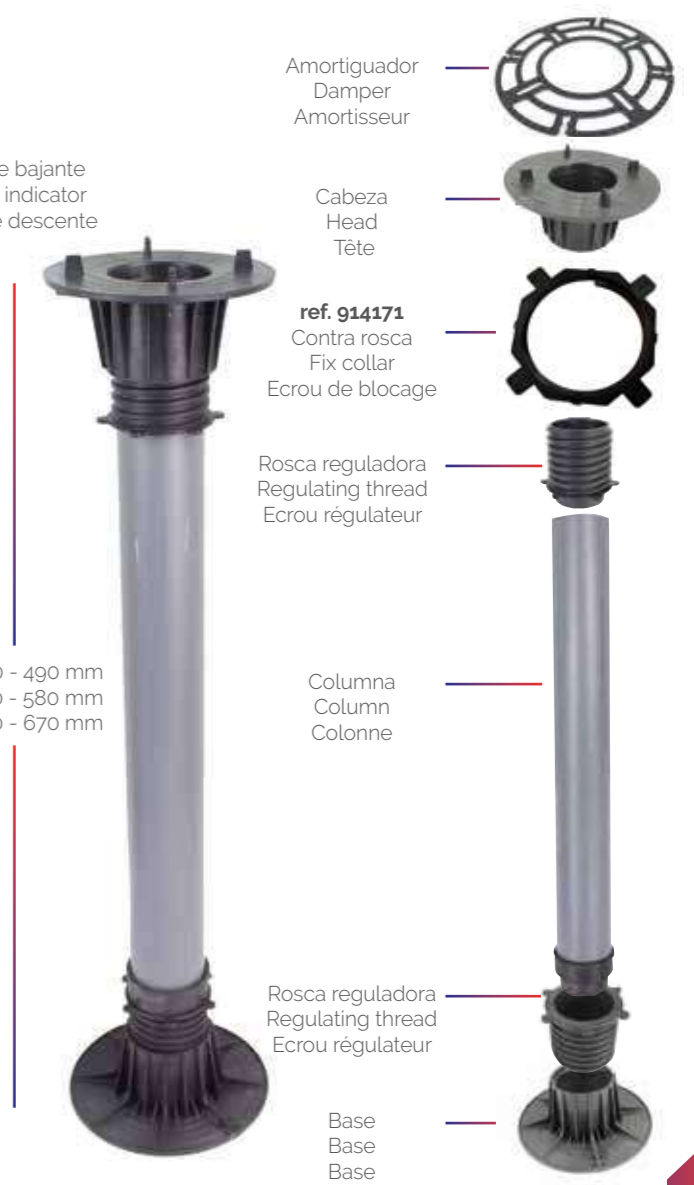

\* Con 2 casquillos  
With 2 extender / Avec 2 bague

Cajas de herramientas y estuches  
Tool boxes and organizers  
Boîtes à outils et coffrets

Productos de ordenación  
Arrangement products  
Produits de rangement

Colección hogar  
Home collection  
Boîtes de rangement Home

Eco Tayg  
Eco Tayg  
Eco Tayg

Tayg Light  
Tayg Light  
Tayg light

Tayg Build  
Tayg Build  
Tayg Build

Lista de packing  
Packing list  
Liste d'emballage



# ACCESORIOS Y COMPLEMENTOS

Accessories and complements / Accessoires et compléments



| MODELO<br>Model / Modèle              | Amortiguador<br>Dumper<br>Amortisseur | Amortiguador<br>Dumper<br>Amortisseur | Contra rosca tb 750<br>Fix collar tb 750<br>Ecrou de blocage tb 750 | Contra rosca tb 1000<br>Fix collar tb 1000<br>Ecrou de blocage tb 1000 | Cuña desnivel 5%<br>Slope corrector 5%<br>Correcteur de pente 5% |
|---------------------------------------|---------------------------------------|---------------------------------------|---|--|--|
| CÓDIGO<br>Code / Code                 | 914119                                | 914157                                | 914164  | 914171   | 914188   |
| MEDIDAS<br>Sizes / Mesures            | Ø 90 mm                               | Ø 140 mm                              | 50 - 70 mm  | 65 - 670 mm  | Ø 160 mm   |
| UDS. BOLSA<br>Units bag<br>Unités sac | -                                     | -                                     | -   | 2  | -  |

\* Soporta modelos desde 10 mm hasta 70 mm / Supports models from 10 mm to 70 mm / Valable pour les modèles de 10 mm à 70 mm

\* Soporta modelos desde 65 mm hasta 670 mm / Supports models from 65 mm to 670 mm / Valable pour les modèles de 65 mm à 670 mm

## BENEFICIOS Benefits / Bénéfices

El sistema de pavimento flotante es una de las grandes soluciones en la instalación de suelo, rápido y sin necesidad de obra, tanto para exteriores como interiores, el cual cuenta con las siguientes ventajas:  
The pedestals are one of the best solutions on the installation of tiles. Quick and without building work, it's valid for outside as well as inside flooring. It counts with the following advantages.  
Le système de sol flottant est une des grandes solutions en pose de sol, rapide et sans besoin de travaux. Autant pour extérieur comme à l'intérieur, avec les avantages suivants.

- 1 Con la cámara de aire que se crea, se convierte en un perfecto aislante térmico y acústico.  
Thanks to the air chamber, it's a perfect thermic and acustic insulation.  
Avec la chamber a air qui se crée, le sol se converti en parfait isolent thermique et phonique.
- 2 Instalación fácil y sin necesidad de obra, ahorrando costes y tiempo.  
Easy installation, saving money and time.  
Installation facile et sans besoin de travaux économie de temps et argent.
- 3 Muy resistente a la carga de peso.  
Highly resistant to weight load.  
Très résistant a la charg de poids.
- 4 Las pestañas de los plots marcan la junta de dilatación.  
The tabs of the plots mark the dilatation joint.  
Les onglets des plots marquent le joint de dilatation.
- 5 Su junta permite el perfecto drenaje de agua.  
The joint allows the perfect water drain.  
Son joint permet leparfait drainage de l'eau.
- 6 Su colocación sin cola permite un cómodo desmontaje y aligera el peso estructural.  
The colocation without mortar allows a handy dismantling and reduces the structural weight.  
Sa pose sans colle permet un démontage facile et allège le poids de la structure.
- 7 El fácil desmontaje permite una fácil instalación de tuberías y cableado.  
The easy dismantling allows the installation of pipes and cables.  
Le facile démontage permet une installation facile de tubes et câbles.

Modo de uso  
Mode of use  
Mode d'utilisation

1 Montaje por partes de los plots. Añadir contra rosca para mayor fijación. / Set by parts the PLOT. Add the locknut for better fixing / Montage du plot par parties. Ajouter le contre écrou pour un meilleur fixaje.



3 Después de colocar la primera baldosa, uso del nivel para ajustar el plot a la altura deseada. Tener en cuenta el desnivel deseado. / After the colocation of the first tile, use the leveler to adjust the PLOT desired level. / Après placer le première carreau. Utiliser le niveau a bulle pour ajuster le plot au niveau désiré.



5 Se prosigue con la colocación de baldosas, para conseguir una correcta uniformidad del pavimento. / We continue with the placement of tiles, to achieve a correct uniformity of the pavement / Nous continuons avec la mise en place des carreaux pour atteindre une uniformité correcte de l'espace.



## MODO DE COLOCACIÓN DE PLOTS Method of attachment / Mode de placement

2 Calculo y trazado del espacio.  
Calculation (measurement) and trace the space.  
Calcule (mesure) et tracé de l'espace.



4 Ajustar la contra rosca para fijar correctamente los plot.  
The locknut ensures and fix the PLOT.  
Le contre écrou fixe et assure le plot.

"Se recomienda el uso de amortiguadores que dotan al sistema de una mayor durabilidad y un mayor aislamiento tanto acústico como térmico. / Its highly recommend the use of damper to give a higher durability and a better acoustic and thermic insulation / Il est recommandé l'utilisation des amortisseurs, ce qui permet une majeure durabilité et un isolement autant thermique que acoustique.

6 Fácil y rápido desmontaje.  
Easy and fast dismantling.  
Facile et rapide démontage.



Cajas de herramientas y estuches  
Tool boxes and organizers  
Boîtes a outils et coffrets

Productos de ordenación  
Arrangement products  
Produits de rangement

Colección hogar  
Home collection  
Boîtes de rangement Home

Eco Tayg  
Eco Tayg  
Eco Tayg

Tayg Light  
Tayg Light  
Tayg light

Tayg Build  
Tayg Build  
Tayg Build

Lista de packing  
Packing list  
Liste d'emballage



# FACHADA, PAVÉS Y ACCESORIOS DE SEGURIDAD

Safety brackets | Safety accessories  
Glass block spacer | Accessoires de sécurité

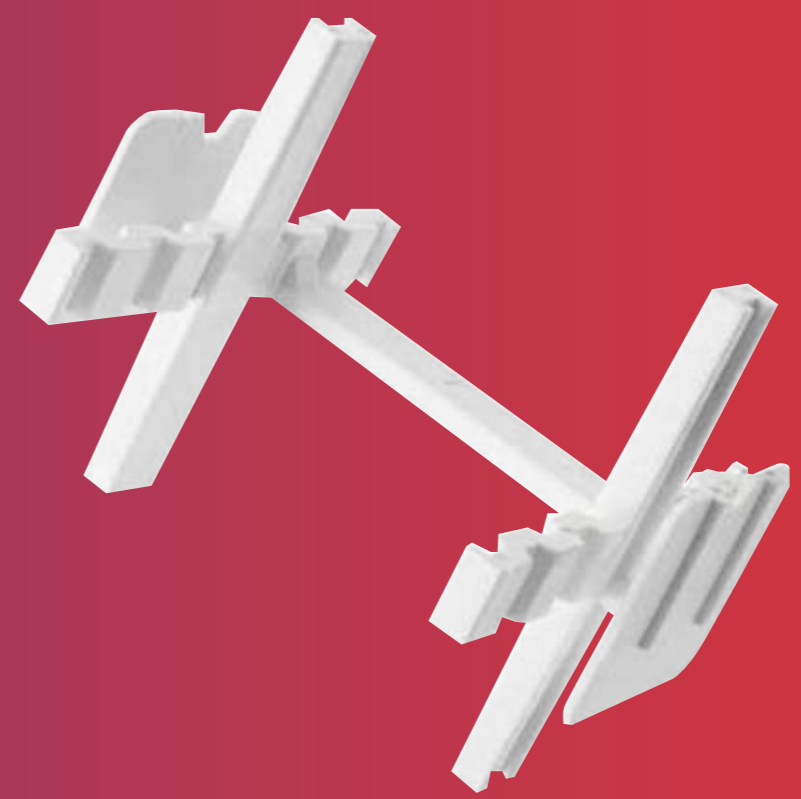



# FACHADA Y PAVÉS

Safety brackets / Glass block spacer

## GRAPAS DE SEGURIDAD FACHADA

Safety bracket / Agrafe façades collées

| MODELO<br>Model / Modèle   | 12 mm<br>Grapa seguridad central<br>Safety initial bracket<br>Agrafe du bord  | 18 mm<br>Grapa seguridad central<br>Safety initial bracket<br>Agrafe du bord  |
|--|---|---|
| CÓDIGO<br>Code / Code  | 915031  | 915048  |
| MEDIDAS<br>Sizes / Mesures   | 12 mm   | 18 mm   |
| CONTIENE<br>Contained / Contient   | 200 tacos 5 x 25 mm<br>200 tornillos 3,5 x 40 mm<br>200 block 5 x 25 mm<br>200 screw 3,5 x 40 mm<br>200 taco 5 x 25 mm<br>200 vis 3,5 x 40 mm | 200 tacos 5 x 25 mm<br>200 tornillos 3,5 x 40 mm<br>200 block 5 x 25 mm<br>200 screw 3,5 x 40 mm<br>200 taco 5 x 25 mm<br>200 vis 3,5 x 40 mm |
| UDS. CAJA<br>Units pack / Unités pack  | 200   | 200   |
| ESPESOR MÁX. FIJACIÓN<br>Maximum Fixing<br>thickness / Epaisseur<br>maximale de fixation | Vista / View / A vue : 10 mm<br>Oculto / Hidden / Cachée : 20 mm  | Vista / View / A vue : 16 mm<br>Oculto / Hidden / Cachée : 32 mm  |
| MATERIAL<br>Material / Matériau  | Acero inoxidable AISI-304<br>Stainless steel AISI-304<br>Acier inoxidable AISI-304  | Acero inoxidable AISI-304<br>Stainless steel AISI-304<br>Acier inoxidable AISI-304  |

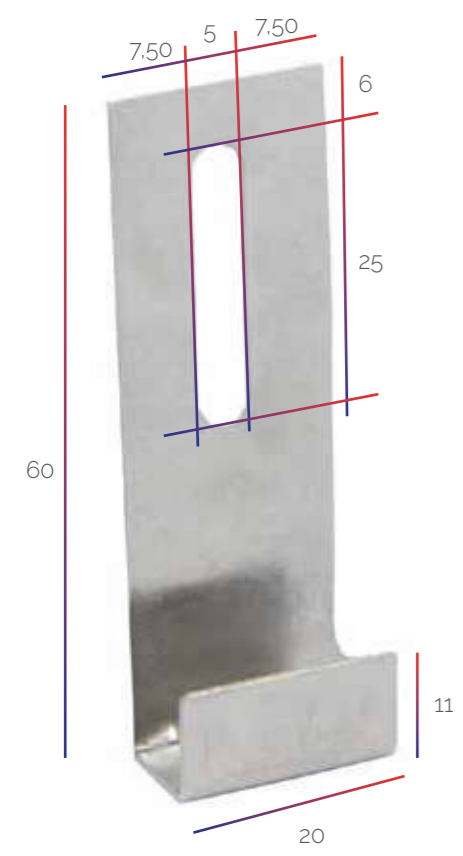
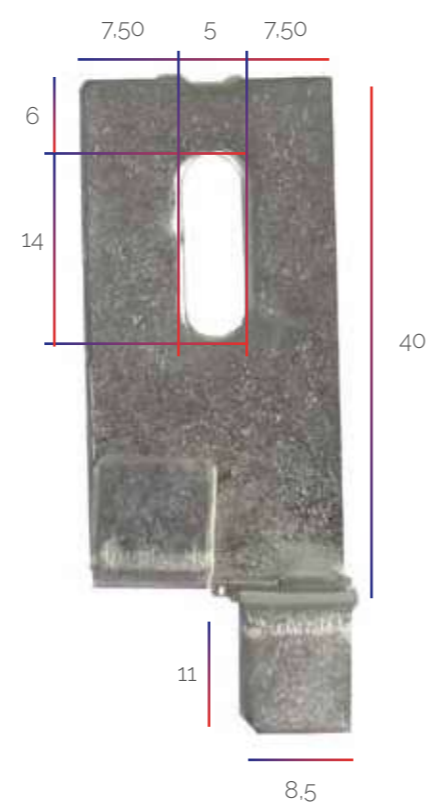

| MODELO<br>Model / Modèle   | 12 mm<br>Grapa seguridad arranque final<br>Safety intermediate bracket<br>Agrafe intermédiaire  | 18 mm<br>Grapa seguridad arranque final<br>Safety intermediate bracket<br>Agrafe intermédiaire  |
|--|---|---|
| CÓDIGO<br>Code / Code  | 915055  | 915062  |
| MEDIDAS<br>Sizes / Mesures   | 12 mm   | 18 mm   |
| CONTIENE<br>Contained / Contient   | 200 tacos 5 x 25 mm<br>200 tornillos 3,5 x 40 mm<br>200 block 5 x 25 mm<br>200 screw 3,5 x 40 mm<br>200 taco 5 x 25 mm<br>200 vis 3,5 x 40 mm | 200 tacos 5 x 25 mm<br>200 tornillos 3,5 x 40 mm<br>200 block 5 x 25 mm<br>200 screw 3,5 x 40 mm<br>200 taco 5 x 25 mm<br>200 vis 3,5 x 40 mm |
| UDS. CAJA<br>Units pack / Unités pack  | 200   | 200   |
| ESPESOR MÁX. FIJACIÓN<br>Maximum Fixing<br>thickness / Epaisseur<br>maximale de fixation | Vista / View / A vue : 10 mm<br>Oculto / Hidden / Cachée : 20 mm  | Vista / View / A vue : 16 mm<br>Oculto / Hidden / Cachée : 32 mm  |
| MATERIAL<br>Material / Matériau  | Acero inoxidable AISI-304<br>Stainless steel AISI-304<br>Acier inoxidable AISI-304  | Acero inoxidable AISI-304<br>Stainless steel AISI-304<br>Acier inoxidable AISI-304  |



Descripción: Los separadores en forma de cruz son los elementos responsables de garantizar la correcta separación de los bloques pavés, con un coste bajo y rapidez de colocación.  
 Description: The glass-block tile spacers on the cross shape are the elements responsible for guarantee the correct separation of the glass-block with a low cost and speed of placement.  
 Description: Les séparateurs en forme de croix sont les éléments responsables de garantir la correcte séparation des blocs en verre, avec un bas cout et une rapidité de pose.

## DISTANCIADOR BLOQUE DE VIDRIO Glass-block tile spacers / Distanciateur bloque de verre

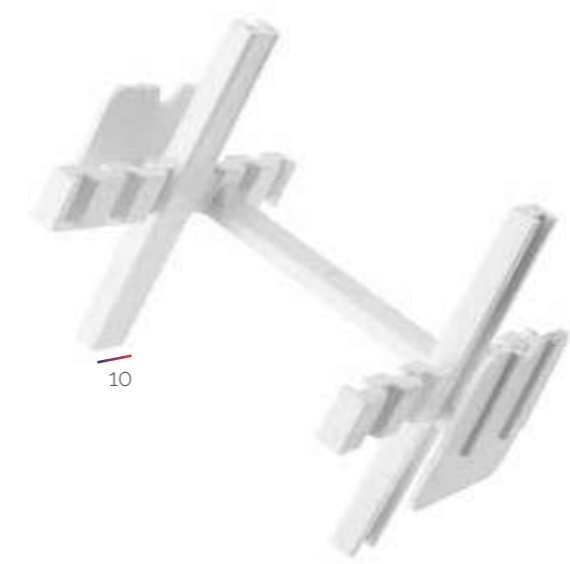

| CÓDIGO<br>Code / Code                     | 915000 | 915017 | 915024 |
|---|--------|--------|--------|
| MEDIDAS<br>Sizes / Mesures                | 10 mm  | 10 mm  | 10 mm  |
| UDS. BOLSA<br>Units bag<br>Unités sac     | -      | -      | 30     |
| UDS. CAJA<br>Units pack<br>Unités pack    | 120    | 300    | 600    |
| CAJAS PALET<br>Pack pallet<br>Pack pallet | 55     | 30     | 16     |

\* Para bloques standard 19 x 19 x 8 mm  
 For standard blocks 19 x 19 x 8 mm  
 Pour des blocs standard 19 x 19 x 8 mm

Cajas de herramientas y estuches  
Tool boxes and organizers  
Boîtes à outils et coffrets

Productos de ordenación  
Arrangement products  
Produits de rangement

Colección hogar  
Home collection  
Boîtes de rangement Home

Eco Tayg  
Eco Tayg  
Eco Tayg

Tayg Light  
Tayg Light  
Tayg light

Tayg Build  
Tayg Build  
Tayg Build

Lista de packing  
Packing list  
Liste d'emballage



# ACCESORIOS DE SEGURIDAD

Safety accessories / Accessoires de sécurité



**Pantalla Protectora Facial Infantil**  
Child Protective Face Shield  
Ecran de Protection Enfant



**Pantalla Protectora Facial Adulto**  
Protective Face Shield  
Ecran de Protection

**MODELO**  
Model / Modèle

| CÓDIGO<br>Code / Code                           | 918094             | 918087             |
|---|--------------------|--------------------|
| <b>MEDIDAS</b><br>Sizes / Mesures               | 160 x 160 x 170 mm | 160 x 160 x 210 mm |
| <b>UDS. BOLSA</b><br>Units bag / Unités sac     | 2                  | 2                  |
| <b>UDS. CAJA</b><br>Units pack / Unités pack    | 70                 | 100                |
| <b>CAJAS PALET</b><br>Pack pallet / Pack pallet | 18                 | 18                 |



Seta protectora (Varilla de 24 a 40 mm)  
Safety cap (rod from 24 to 40 mm)  
Champignon protecteur (barre de 24 a 40 mm)

Pantalla Protectora Facial Infantil  
Child Protective Face Shield  
Ecran de Protection Enfant



Seta protectora "P"  
(Varilla de 8 a 20 mm)  
Safety cap "P" (rod from 8 a 20 mm)  
Champignon protecteur "P"  
(barre de 8 a 20 mm)



Seta protectora (Varilla de 8 a 20 mm)  
Safety cap (rod from 8 a 20 mm)  
Champignon protecteur  
(barre de 8 a 20 mm)



Seta protectora (Varilla de 24 a 40 mm)  
Safety cap (rod from 24 to 40 mm)  
Champignon protecteur  
(barre de 24 a 40 mm)

**MODELO**  
Model / Modèle

| CÓDIGO<br>Code / Code                             | 918001 | 918018 | 918025 |
|---|--------|--------|--------|
| <b>UDS. BOLSA</b><br>Units Bag / Unités sac       | 250    | 250    | 150    |
| <b>UDS. PALET</b><br>Units pallet / Unités pallet | 19,500 | 15,000 | 5,400  |



Base guardacuerpos conix  
Conix base  
Base conix



**MODELO**  
Model / Modèle

| CÓDIGO<br>Code / Code                             | 918070     | 918063     |
|---|------------|------------|
| <b>MEDIDAS</b><br>Sizes / Mesures                 | 60 x 40 mm | 80 x 85 mm |
| <b>UDS. BOLSA</b><br>Units Bag / Unités sac       | 50         | 64         |
| <b>UDS. PALET</b><br>Units pallet / Unités pallet | 2,500      | 1,280      |



**MODELO**  
Model / Modèle

| CÓDIGO<br>Code / Code                             | 918032 | 918049 | 918056     |
|---|--------|--------|------------|
| <b>MEDIDAS</b><br>Sizes / Mesures                 | 40 mm  | 40 mm  | 35 x 35 mm |
| <b>UDS. BOLSA</b><br>Units Bag / Unités sac       | 150    | 150    | 150        |
| <b>UDS. PALET</b><br>Units pallet / Unités pallet | 3,600  | 3,150  | 3,150      |

Con tapa incorporada  
Bouchon incorporé  
Incorporated cover



Cod. 918049

Base cajetín línea de vida  
Base life line  
Base boîte de ligne de vie

Base horcax (valla de seguridad)  
Base horca (safety fence)  
Base horcax (cloture de securite)



Base guardacuerpos "conix"  
Conix base  
Base garde-corps conix



Base guardacuerpos "conix"  
Conix base  
Base garde-corps conix

Base guardacuerpos cuadrado  
Guardrail base  
Base garde-corps carrée

Cajas de herramientas y estuches  
Tool boxes and organizers  
Boîtes à outils et coffrets

Productos de ordenación  
Arrangement products  
Produits de rangement

Colección hogar  
Home collection  
Boîtes de rangement Home

Eco Tayg  
Eco Tayg  
Eco Tayg

Tayg Light  
Tayg Light  
Tayg light

Tayg Build  
Tayg Build  
Tayg Build

Lista de packing  
Packing list  
Liste d'emballage



# ACCESORIOS PARA ENCOFRADO

Formwork accessories  
Accessoires pour coffrage

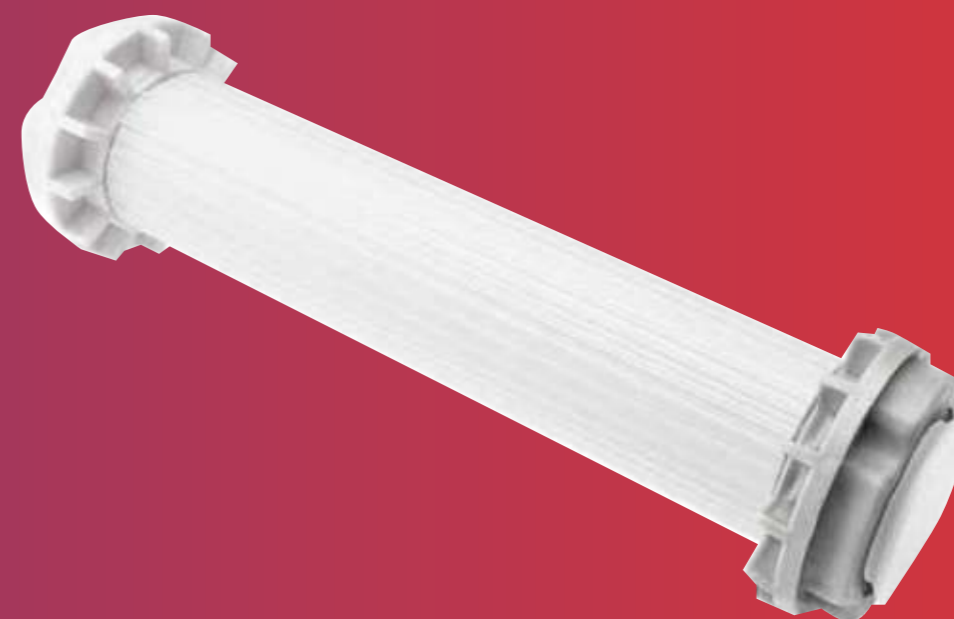



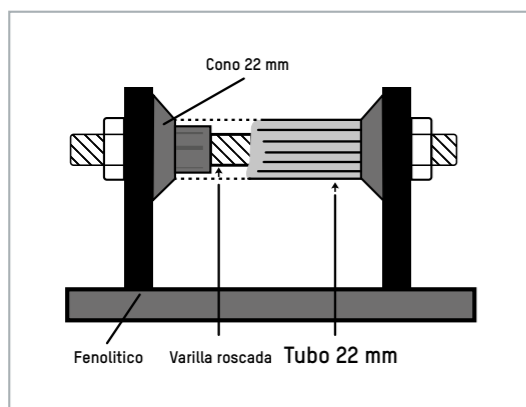

Cod. 916007



Cono tubos pasamuro Ø 22  
Bushing cone cône Ø 22  
Tubes de passage Ø 22

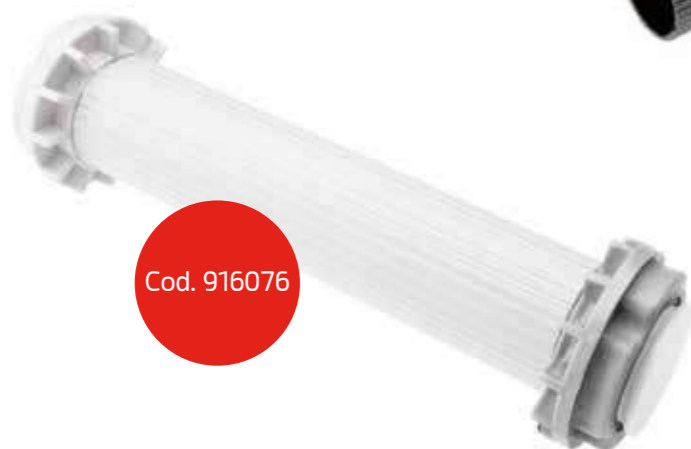

Cod. 916076

|                                 |   |   |   |   |  |
|---------------------------------|---|---|---|---|--|
| <b>MODELO</b><br>Model / Modèle | Tubo encofrado - pasamuro Ø 22<br>Formwork tube Ø 22<br>Tuyau de passage de coffrage Ø 22 | Tubo encofrado - pasamuro Ø 26<br>Formwork tube Ø 26<br>Tuyau de passage de coffrage Ø 26 | Cono tubos pasamuro Ø 22<br>Bushing cone cône Ø 22<br>Tubes de passage Ø 22 | Cono tubos pasamuro Ø 26<br>Bushing cone cône Ø 26<br>Tubes de passage Ø 26 | Cono estanco y muro visto Ø 22<br>Cone waterproof raw wall Ø 22<br>Cône etanche et mur apparent Ø 22 |
|---------------------------------|---|---|---|---|--|

| CÓDIGO<br>Code / Code  | 916007          | 916014          | 916090 | 916106 | 916076 |
|--|-----------------|-----------------|--------|--------|--------|
| <b>MEDIDAS</b><br>Sizes / Mesures                              | Ø 22-26 x 2 mts | Ø 26-30 x 2 mts | 22 mm  | 26 mm  | 22 mm  |
| <b>UDS. ATADO</b><br>Units / Unités                            | 25              | 20              | -      | -      | -      |
| <b>PAQUETES PALET</b><br>Pallet packages<br>Paquets de palette | 60              | 60              | 52.000 | 30.000 | 51.000 |
| <b>UDS. BOLSA</b><br>Units bag<br>Unités sac                   | -               | -               | 500    | 500    | 500    |
| <b>BOLSAS PALET</b><br>Bags pallet<br>Sacs pallet              | -               | -               | 104    | 60     | 102    |



Cod. 916083

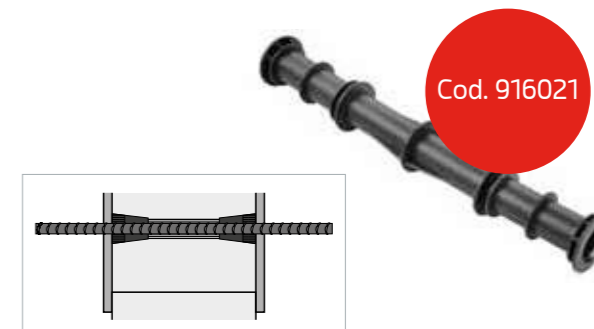

Cod. 916021

**MODELO**  
Model / Modèle

|   |  |  |  |  |
|---|--|--|--|--|
| Ø 16<br>Tapón estriado para encofrado<br>Striated plug for formwork<br>Bouchon estrié pour coffrage | Ø 18<br>Tapón liso para encofrado<br>Flat plug for formwork<br>Bouchon lisse pour coffrage | Ø 22<br>Tapón liso para encofrado<br>Flat plug for formwork<br>Bouchon lisse pour coffrage | Ø 24<br>Tapón liso para encofrado<br>Flat plug for formwork<br>Bouchon lisse pour coffrage | Ø 26<br>Tapón liso para encofrado<br>Flat plug for formwork<br>Bouchon lisse pour coffrage |
|---|--|--|--|--|

| CÓDIGO<br>Code / Code                             | 916113  | 916120  | 916205  | 916144 | 916151 |
|---|---------|---------|---------|--------|--------|
| <b>MEDIDAS</b><br>Sizes / Mesures                 | 16 mm*  | 18 mm   | 22 mm   | 24 mm  | 26 mm  |
| <b>UDS. BOLSA</b><br>Units bag / Unités sac       | 1.000   | 1.000   | 500     | 500    | 500    |
| <b>UDS. CAJA</b><br>Units pack / Unités pack      | 30.000  | 18.000  | 3.500   | 4.500  | 4.500  |
| <b>UDS. PALET</b><br>Units pallet / Unités pallet | 300.000 | 360.000 | 105.000 | 90.000 | 90.000 |

**MODELO**  
Model / Modèle

|  |  |  |  |
|--|--|--|--|
| Tapón estriado estanco y muro visto Ø 22<br>Plug. waterproof raw wall Ø 22<br>Bouchon strie etanche et mur apparent Ø 22 | Tubo rápido encofrado - pasamuro Ø 22<br>Fast formwork tube Ø 22<br>Tuyau de passage rapide de coffrage Ø 22 | Tubo rápido encofrado - pasamuro Ø 22<br>Fast formwork tube Ø 22<br>Tuyau de passage rapide de coffrage Ø 22 | Tubo rápido encofrado - pasamuro Ø 22<br>Fast formwork tube Ø 22<br>Tuyau de passage rapide de coffrage Ø 22 |
|--|--|--|--|

| CÓDIGO<br>Code / Code                             | 916083  | 916021 | 916038 | 916045 |
|---|---------|--------|--------|--------|
| <b>MEDIDAS</b><br>Sizes / Mesures                 | 22 mm   | 200 mm | 250 mm | 300 mm |
| <b>UDS. BOLSA</b><br>Units bag / Unités sac       | 500     | -      | -      | -      |
| <b>UDS. CAJA</b><br>Units pack / Unités pack      | 4.000   | 200    | 150    | 100    |
| <b>UDS. PALET</b><br>Units pallet / Unités pallet | 168.000 | 5.600  | 4.200  | 3.000  |



# BERENJENO Y JUNTA DILATACIÓN

Chamfer strip and dilatation joint / Liteau triangulaire et joint de dilatation

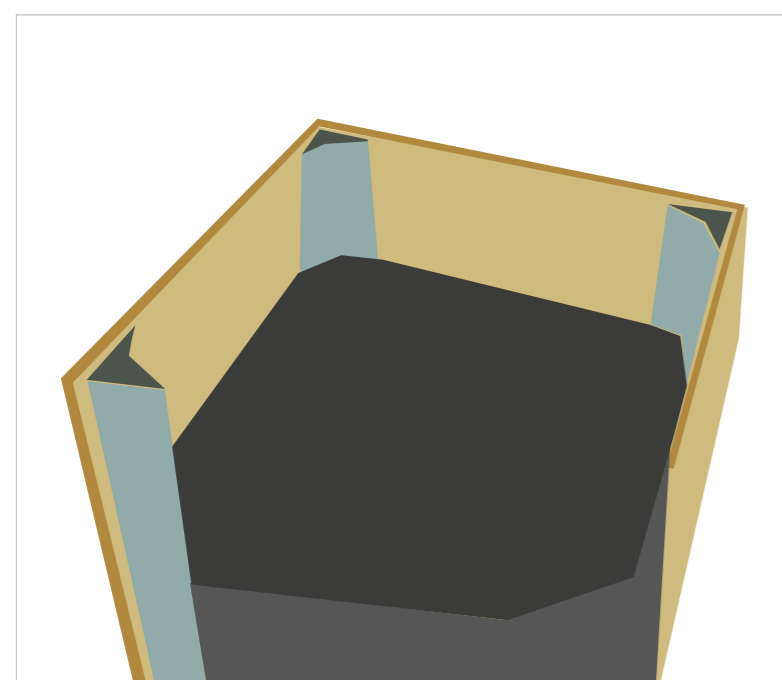

Berenjeno  
Chamfer  
Liteau triangulaire

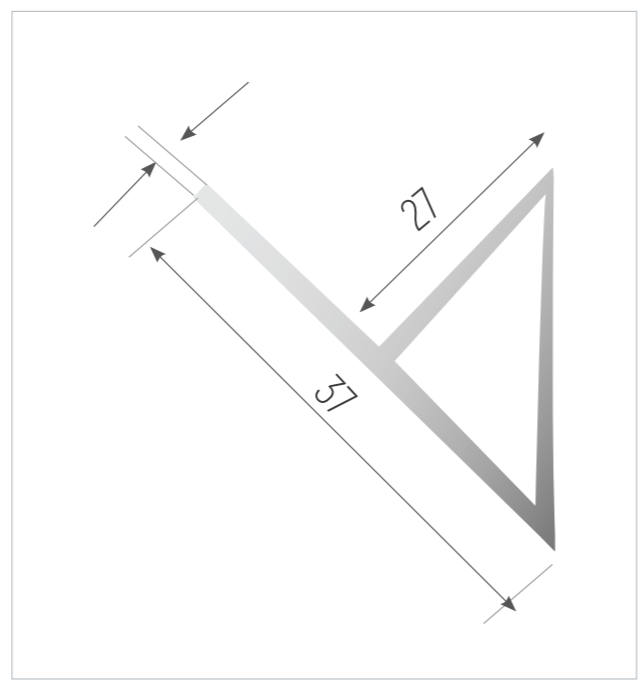

Berenjeno alas  
Large chamfer strip  
Liteau triangulaire avec aile

\* Para otros colores y medidas consultar a fábrica.  
Check with the company for another sizes and colours.  
Pour d'autres couleurs et tailles, consulter l'usine.

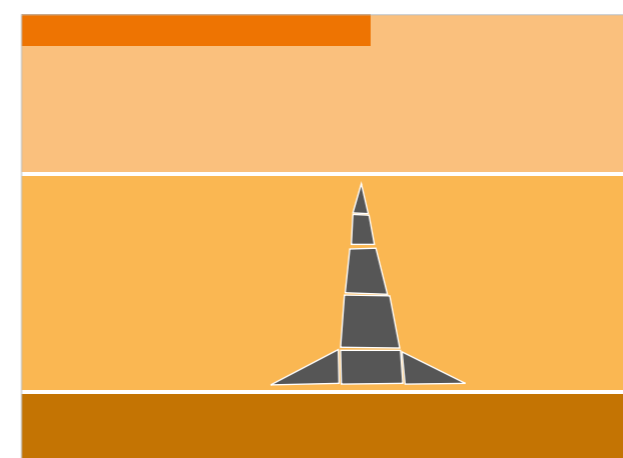

Junta de dilatación / Dilatation joint / Joint de dilatation



Junta de dilatación  
Dilatation joint  
Joint de dilatation



| MODELO<br>Model / Modèle | Berenjeno PVC 15 mm<br>Chamfer strip<br>Liteau triangulaire | Berenjeno ala PVC 20 mm<br>Large chamfer strip PVC 20 mm<br>Liteau triangulaire avec aile PVC 20 mm | Berenjeno PVC 20 mm<br>Chamfer strip<br>Liteau triangulaire | Berenjeno PVC 25 mm<br>Chamfer strip<br>Liteau triangulaire | Berenjeno PVC 30 mm<br>Chamfer strip<br>Liteau triangulaire |
|--------------------------|---|---|---|---|---|
|--------------------------|---|---|---|---|---|

| CÓDIGO<br>Code / Code                        | 916212           | 916199           | 916168           | 916175           | 916182           |
|--|------------------|------------------|------------------|------------------|------------------|
| MEDIDAS<br>Sizes / Mesures                   | 15 mm x 2,50 mts | 20 mm x 2,50 mts | 20 mm x 2,50 mts | 25 mm x 2,50 mts | 30 mm x 2,50 mts |
| UDS. CAJA<br>Units pack<br>Unités pack       | 100              | 50               | 50               | 50               | 50               |
| CAJAS<br>PALET<br>Pack pallet<br>Pack pallet | 20               | 20               | 20               | 20               | 20               |

| MODELO<br>Model / Modèle | Junta de dilatación 40 mm<br>Dilatation joint 40 mm<br>Joint de dilatation 40 mm | Junta de dilatación 80 mm<br>Dilatation joint 80 mm<br>Joint de dilatation 80 mm |
|--------------------------|--|--|
|--------------------------|--|--|

| CÓDIGO<br>Code / Code                        | 916229           | 916236           |
|--|------------------|------------------|
| MEDIDAS<br>Sizes / Mesures                   | 40 mm x 2,50 mts | 80 mm x 2,50 mts |
| UDS. CAJA<br>Units pack<br>Unités pack       | 30               | 20               |
| CAJAS<br>PALET<br>Pack pallet<br>Pack pallet | 30               | 15               |

Cajas de herramientas y estuches  
 Tool boxes and organizers  
 Boîtes à outils et coffrets  
 Productos de ordenación  
 Arrangement products  
 Produits de rangement  
 Colección hogar  
 Home collection  
 Boîtes de rangement Home  
 Eco Tayg  
 Eco Tayg  
 Eco Tayg  
 Tayg Light  
 Tayg Light  
 Tayg light  
 Tayg Build  
 Tayg Build  
 Tayg Build  
 Lista de packing  
 Packing list  
 Liste d'emballage

## SEPARADORES DE PARRILLA, SIERRA

Rectangular plastic spacer, saw plastic spacer, spacer / Separateur de grillage, separateur scie, séparateur

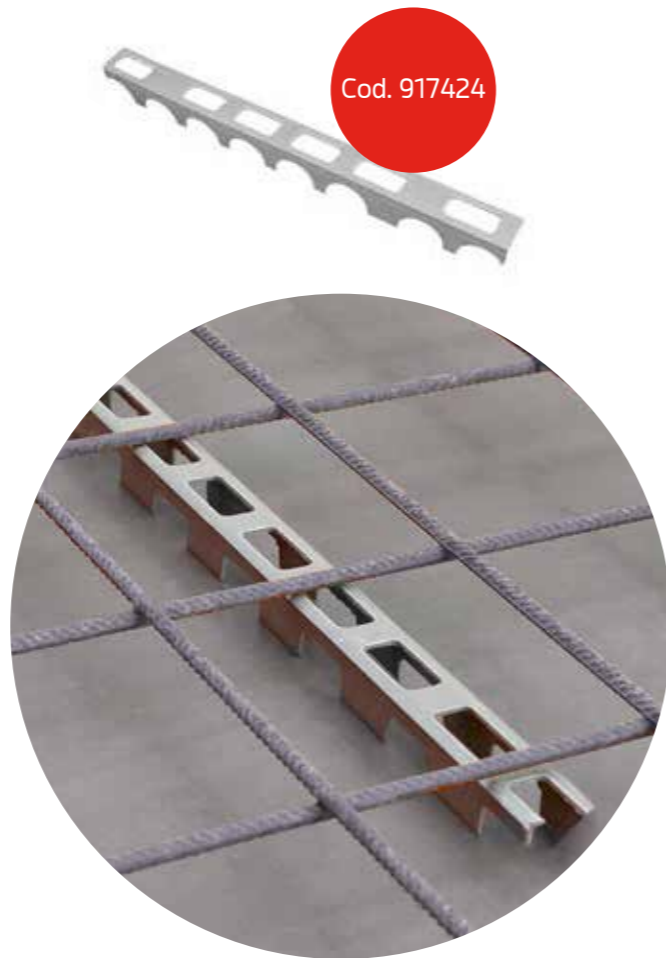

### SEPARADOR SIERRA

Saw plastic spacer / Separateur scie

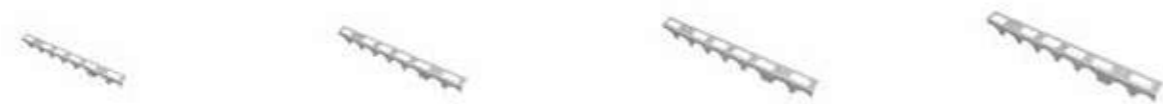

| MODELO<br>Model / Modèle   | Separador 25 mm<br>Spacer / Separateur   | Separador 30 mm<br>Spacer / Separateur   | Separador 40 mm<br>Spacer / Separateur   | Separador 50 mm<br>Spacer / Separateur   |
|--|--|--|--|--|
| <b>CÓDIGO</b><br>Code / Code                                     | <b>917417</b>                            | <b>917424</b>                            | <b>917431</b>                            | <b>917448</b>                            |
| <b>MEDIDAS</b><br>Sizes/ Mesures                                 | 25 mm x 2 mts                            | 30 mm x 2 mts                            | 40 mm x 2 mts                            | 50 mm x 2 mts                            |
| <b>UDS. ATADO</b><br>Units tied<br>Unités attaché                | 50 tiras / Strips / Bandes<br>(100 mts)  | 50 tiras / Strips / Bandes<br>(100 mts)  | 24 tiras / Strips / Bandes<br>(60 mts)   | 30 tiras / Strips / Bandes<br>(60 mts)   |
| <b>ATADO POR PALET</b><br>Tied per pallet<br>Attaché par palette | 49 atados / Tied /<br>Attaché (4900 mts) | 42 atados / Tied /<br>Attaché (4200 mts) | 76 atados / Tied /<br>Attaché (2400 mts) | 28 atados / Tied /<br>Attaché (1680 mts) |

## SEPARADORES PARA ENCOFRADOS

Formwork spacers / Séparateurs pour coffrage

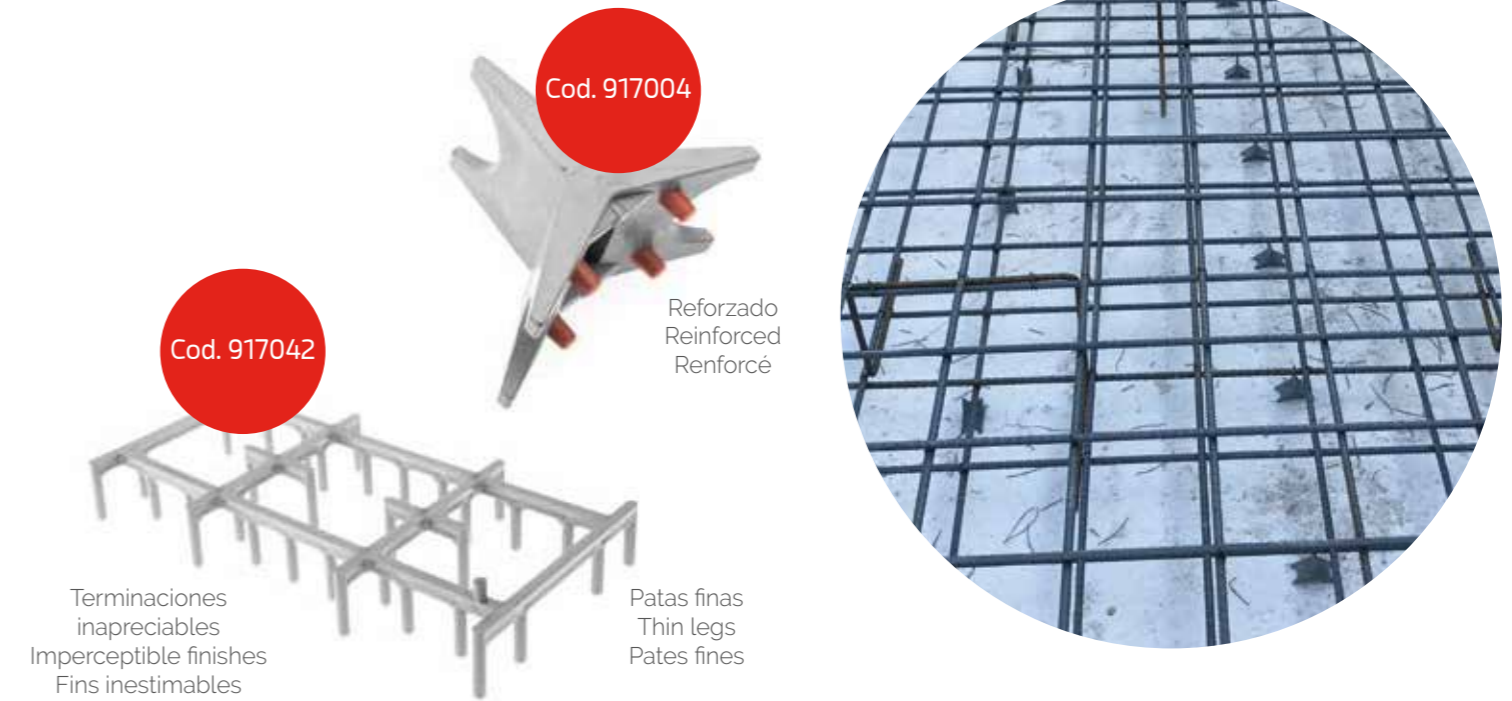

Terminaciones  
inapreciables  
Imperceptible finishes  
Fins inestimables

Patas finas  
Thin legs  
Pates fines

Reforzado  
Reinforced  
Renforcé

**SEPARADOR DE PARRILLA 105 x 250 mm**  
Rectangular plastic spacer 105 x 250mm / Separateur de grillage 105 x 250mm



| CÓDIGO<br>Code / Code                            | 917042 | 917059 | 917066 | 917073 | 917080 | 917097 |
|--|--------|--------|--------|--------|--------|--------|
| <b>MEDIDAS</b><br>Sizes/ Mesures                 | 20 mm  | 25 mm  | 30 mm  | 35 mm  | 40 mm  | 50 mm  |
| <b>UDS. CAJA</b><br>Units pack<br>Unités pack    | 268    | 228    | 200    | 176    | 152    | 120    |
| <b>CAJAS PALET</b><br>Pack pallet<br>Pack pallet | 20     | 20     | 20     | 20     | 20     | 20     |

**SEPARADOR CONDOR**  
Condor spacer / Separateur condor



| CÓDIGO<br>Code / Code                            | 917004 | 917011 | 917028 | 917035 |
|--|--------|--------|--------|--------|
| <b>MEDIDAS</b><br>Sizes/ Mesures                 | 20 mm  | 30 mm  | 40 mm  | 50 mm  |
| <b>UDS. BOLSA</b><br>Units Bag / Unités sac      | 1.000  | 500    | 500    | 500    |
| <b>UDS PALET</b><br>Units pallet / Unités pallet | 90.000 | 48.000 | 30.000 | 18.000 |



## SEPARADORES PARA ENCOFRADOS

Formwork spacers / Séparateurs pour coffrage

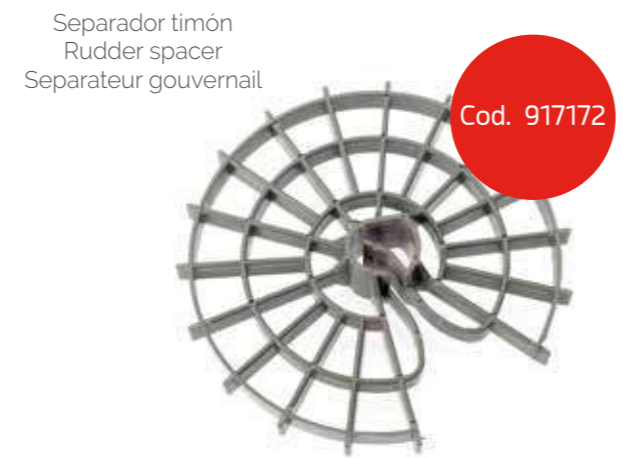
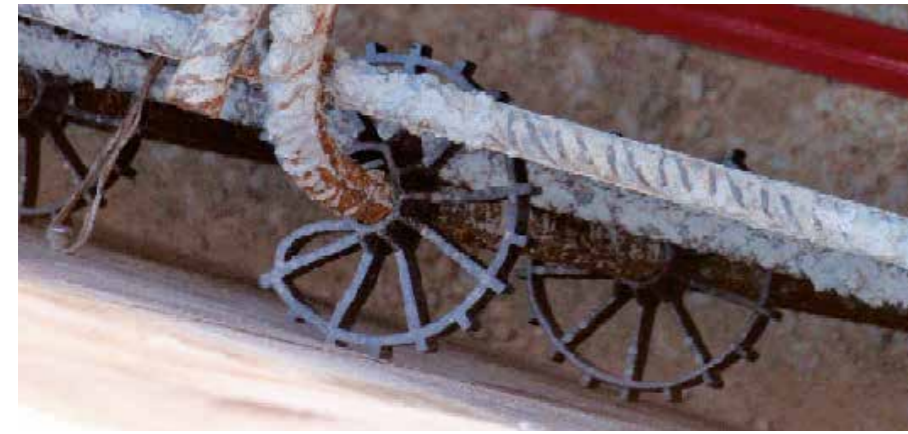

### SEPARADOR TIMÓN

Rudder spacer / Séparateur gouvernail



| CÓDIGO<br>Code / Code                      | 917103 | 917110 | 917127 | 917134 | 917141  |
|--|--------|--------|--------|--------|---------|
| MEDIDAS<br>Sizes/ Mesures                  | 20 mm  | 25 mm  | 30 mm  | 35 mm  | 40 mm   |
| ØVARILLA<br>Ø Dipstick / Ø Tige            | 6 - 12 | 6 - 12 | 6 - 14 | 6 - 14 | 12 - 20 |
| UDS. BOLSA<br>Units bag / Unités sac       | 1.000  | 1.000  | 500    | 500    | 200     |
| UDS. PALET<br>Units pallet / Unités pallet | 48.000 | 36.000 | 18.000 | 14.000 | 10.400  |

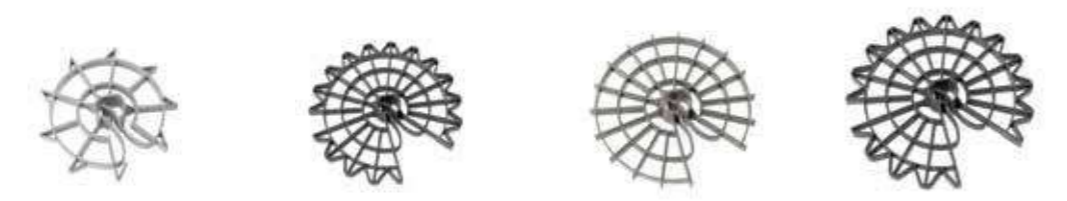

| CÓDIGO<br>Code / Code                      | 917158  | 917165<br>REFORZADO | 917172  | 917189<br>REFORZADO |
|--|---------|---------------------|---------|---------------------|
| MEDIDAS<br>Sizes/ Mesures                  | 50 mm   | 50 mm               | 60 mm   | 70 mm               |
| ØVARILLA<br>Ø Dipstick / Ø Tige            | 12 - 20 | 12 - 20             | 12 - 20 | 12 - 20             |
| UDS. BOLSA<br>Units bag / Unités sac       | 200     | 200                 | 200     | 150                 |
| UDS. PALET<br>Units pallet / Unités pallet | 8.000   | 7.200               | 4.800   | 3.150               |

## SEPARADORES DE HORMIGÓN

Concrete spacer / Séparateur de béton



### SEPARADOR DE HORMIGÓN

Concrete spacer / Séparateur de béton



| MODELO<br>Model / Modèle                  | Separador cubito 20 mm<br>Concrete cube spacer<br>20 mm<br>Cale béton bloc 20 mm | Separador cubito 25 mm<br>Concrete cube spacer<br>25 mm<br>Cale béton bloc 25 mm | Separador cubito 30 mm<br>Concrete cube spacer<br>30 mm<br>Cale béton bloc 30 mm | Separador cubito 35 mm<br>Concrete cube spacer<br>35 mm<br>Cale béton bloc 35 mm |
|---|--|--|--|--|
| CÓDIGO<br>Code / Code                     | 917226   | 917233   | 917240   | 917257   |
| MEDIDAS<br>Sizes/ Mesures                 | 20 mm  | 25 mm  | 30 mm  | 35 mm  |
| UDS. BOLSA<br>Units bag / Unités sac      | 700  | 400  | 300  | 250  |
| BOLSAS PALET<br>Bags pallet / Sacs pallet | 50   | 50   | 50   | 40   |

\* Pedidos por referencia palet completo. Reference per order full pallet / Commandes par référence palette complète.



| MODELO<br>Model / Modèle                  | Separador cubito 40 mm<br>Concrete cube spacer 40 mm<br>Cale béton bloc 40 mm | Separador cubito 50 mm<br>Concrete cube spacer 50 mm<br>Cale béton bloc 50 mm | Separador cubito 60 mm<br>Concrete cube spacer 60 mm<br>Cale béton bloc 60 mm | Separador cubito 70 mm<br>Concrete cube spacer 70 mm<br>Cale béton bloc 70 mm |
|---|---|---|---|---|
| CÓDIGO<br>Code / Code                     | 917264  | 917271  | 917288  | 917295  |
| MEDIDAS<br>Sizes/ Mesures                 | 40 mm   | 50 mm   | 60 mm   | 70 mm   |
| UDS. BOLSA<br>Units bag / Unités sac      | 200   | 150   | 125   | 100   |
| BOLSAS PALET<br>Bags pallet / Sacs pallet | 40  | 45  | 40  | 40  |

\* Pedidos por referencia palet completo. Reference per order full pallet / Commandes par référence palette complète.

Tayg Build  
 Eco Tayg  
 Tayg Light  
 Tayg Light  
 Tayg Light  
 Tayg Light  
 Tayg Build  
 Tayg Build  
 Tayg Build  
 Lista de packing  
 Packing list  
 Liste d'emballage  
 Colección hogar  
 Home collection  
 Boîtes de rangement Home  
 Productos de ordenación  
 Arrangement products  
 Produits de rangement  
 Cajas de herramientas y estuches  
 Tool boxes and organizers  
 Boîtes à outils et coffrets



# SEPARADORES DE HORMIGÓN

Concrete spacer / Séparateur de béton



Separador trivalente  
Concrete trivalent spacer  
Cale béton trivalente



Cod.  
917318



**20 x 25 x 30 mm**  
Separador trivalente  
Concrete trivalent spacer  
Cale béton trivalente



**35 x 40 x 50 mm**  
Separador trivalente  
Concrete trivalent spacer  
Cale béton trivalente



**35 x 40 x 50 mm**  
Separador trivalente con alambre  
Concrete trivalent spacer with wire  
Cale béton trivalente avec câble



**45 x 55 x 60 mm**  
Separador trivalente  
Concrete trivalent spacer  
Cale béton trivalente

**MODELO**  
Model / Modèle

| CÓDIGO<br>Code / Code                           | 917202          | 917196          | 917400          | 917219          |
|---|-----------------|-----------------|-----------------|-----------------|
| <b>MEDIDAS</b><br>Sizes / Mesures               | 20 x 25 x 30 mm | 35 x 40 x 50 mm | 35 x 40 x 50 mm | 45 x 55 x 60 mm |
| <b>UDS. CAJA</b><br>Units pack / Unités pack    | 700             | 200             | 200             | 125             |
| <b>CAJAS PALET</b><br>Pack pallet / Pack pallet | 40              | 50              | 50              | 40              |

\* Pedidos por referencia palet completo. Reference per order full pallet / Commandes par référence palette complète.



**35 mm**  
Redondo hormigón  
Concrete circular spacer  
Cale béton circulaire



**70 mm**  
Redondo hormigón  
Concrete circular spacer  
Cale béton circulaire



**75 mm**  
Redondo hormigón  
Concrete circular spacer  
Cale béton circulaire



**120 mm**  
Separador reticular  
Reticulate spacer  
Cale béton réticulé

**MODELO**  
Model / Modèle

| CÓDIGO<br>Code / Code                           | 917332 | 917318 | 917325 | 917301 |
|---|--------|--------|--------|--------|
| <b>MEDIDAS</b><br>Sizes / Mesures               | 35 mm  | 70 mm  | 75 mm  | 120 mm |
| <b>UDS. CAJA</b><br>Units pack / Unités pack    | 100    | -      | -      | 100    |
| <b>CAJAS PALET</b><br>Pack pallet / Pack pallet | 40     | 475    | 240    | 60     |

\* Pedidos por referencia palet completo. Reference per order full pallet / Commandes par référence palette complète.



Cod.  
917387



Taco con alambre  
Concrete spacer with wire  
Taco avec câble



| MODELO<br>Model / Modèle | 20 mm  | 25 mm  | 30 mm  | 40 mm  | 50 mm  | 60 mm  |
|--------------------------|--|--|--|--|--|--|
|                          | Taco con alambre<br>Concrete spacer with wire<br>Taco avec câble | Taco con alambre<br>Concrete spacer with wire<br>Taco avec câble | Taco con alambre<br>Concrete spacer with wire<br>Taco avec câble | Taco con alambre<br>Concrete spacer with wire<br>Taco avec câble | Taco con alambre<br>Concrete spacer with wire<br>Taco avec câble | Taco con alambre<br>Concrete spacer with wire<br>Taco avec câble |

| CÓDIGO<br>Code / Code                           | 917349 | 917356 | 917363 | 917370 | 917387 | 917394 |
|---|--------|--------|--------|--------|--------|--------|
| <b>MEDIDAS</b><br>Sizes / Mesures               | 20 mm  | 25 mm  | 30 mm  | 40 mm  | 50 mm  | 60 mm  |
| <b>UDS. CAJA</b><br>Units pack / Unités pack    | 500    | 400    | 300    | 250    | 200    | 125    |
| <b>CAJAS PALET</b><br>Pack pallet / Pack pallet | 40     | 50     | 45     | 40     | 40     | 40     |

\* Pedidos por referencia palet completo. Reference per order full pallet / Commandes par référence palette complète.

Cajas de herramientas y estuches  
Tool boxes and organizers  
Boîtes à outils et coffrets

Productos de ordenación  
Arrangement products  
Produits de rangement

Colección hogar  
Home collection  
Boîtes de rangement Home

Eco Tayg  
Eco Tayg  
Eco Tayg

Tayg Light  
Tayg Light  
Tayg light

Tayg Build  
Tayg Build  
Tayg Build

Lista de packing  
Packing list  
Liste d'emballage



# CAPAZOS

Fix collar / Seau de chantier



Cod.  
919152



Cod. 919121



Cod.  
919138



**Capazo Obra 26**  
Fix collar 26  
Seau de chantier 26



**Capazo Obra 42**  
Fix collar 42  
Seau de chantier 42



**Capazo Obra 65**  
Fix collar 65  
Seau de travail 65

**MODELO**  
Model / Modèle

| CÓDIGO<br>Code / Code  | 919114  | 919152  | 919121  |
|--|---|---|---|
| <b>MEDIDAS</b><br>Sizes / Mesures                                | 400 x 350 x 340 mm  | 490 x 430 x 385mm   | 615 x 560 x 380 mm  |
| <b>MATERIAL</b><br>Material / Matériau                           | Polietileno.<br>Plástico reciclado no toxico<br>Polyethylene.<br>Non-toxic recycled plastic<br>Polyéthylène.<br>Plastique recyclé non toxique | Polietileno.<br>Plástico reciclado no toxico<br>Polyethylene.<br>Non-toxic recycled plastic<br>Polyéthylène.<br>Plastique recyclé non toxique | Polietileno.<br>Plástico reciclado no toxico<br>Polyethylene.<br>Non-toxic recycled plastic<br>Polyéthylène.<br>Plastique recyclé non toxique |
| <b>CAPACIDAD</b><br>Capacity / Capacité                          | 26 L  | 42 L  | 65 L  |
| <b>UDS. ATADO</b><br>Units tied<br>Unités attaché                | 12  | 12  | 6   |
| <b>ATADO POR PALET</b><br>Tied per pallet<br>Attaché par palette | 80  | 50  | 60  |

**MODELO**  
Model / Modèle

**Cubo Obra 26**  
Construction Flexible Tub  
Bucket 26  
Seau de chantier 26

**21 L Cubo de mezcla**  
Mixing bucket  
Cube de mélange

**Capazo Vendimia 14**  
Vineyard flexible tub  
bucket 14  
Seau de vendange 14

**Capazo Vendimia 30**  
Vineyard flexible tub  
bucket 30  
Seau de vendange 30

| CÓDIGO<br>Code / Code  | 919138  | 919015         | 919107  | 919145  |
|--|---|----------------|---|---|
| <b>MEDIDAS</b><br>Sizes / Mesures                                | 350 x 350 x 330 mm  | Ø 300 x 875 mm | 410 x 330 x 240 mm  | 470 x 430 x 280 mm  |
| <b>MATERIAL</b><br>Material<br>Matériau                          | Polietileno.<br>Plástico reciclado no toxico<br>Polyethylene.<br>Non-toxic recycled plastic<br>Polyéthylène.<br>Plastique recyclé non toxique | -              | Polietileno.<br>Plástico reciclado no toxico<br>Polyethylene.<br>Non-toxic recycled plastic<br>Polyéthylène.<br>Plastique recyclé non toxique | Polietileno.<br>Plástico reciclado no toxico<br>Polyethylene.<br>Non-toxic recycled plastic<br>Polyéthylène.<br>Plastique recyclé non toxique |
| <b>CAPACIDAD</b><br>Capacity<br>Capacité                         | 26 L  | 21 L           | 14 L  | 30 L  |
| <b>UDS. ATADO</b><br>Units tied<br>Unités attaché                | 12  | 8              | 12  | 12  |
| <b>ATADO POR PALET</b><br>Tied per pallet<br>Attaché par palette | 80  | -              | 64  | 48  |
| <b>UDS. PALET</b><br>Units pallet /<br>Unités pallet             | -   | 160            | -   | -   |

Cajas de herramientas y estuches  
Tool boxes and organizers  
Boîtes à outils et coffrets

Productos de ordenación  
Arrangement products  
Produits de rangement

Colección hogar  
Home collection  
Boîtes de rangement Home

Eco Tayg  
Eco Tayg  
Eco Tayg

Tayg Light  
Tayg Light  
Tayg light

Tayg Build  
Tayg Build  
Tayg Build

Lista de packing  
Packing list  
Liste d'emballage

# LISTA DE PACKING

Packing list | Liste d'emballage  
Verpackungsliste

Escanea código QR  
Scan QR code  
Scanner le code QR  
QR-code scannen



# 08





Síguenos en:



Industrias Tayg, S.L.U.

Avda. Real de Madrid Norte, 70 - 46469 Beniparrell - Valencia (Spain)

Tlf. +34 96 121 24 62 | [marketing@tayg.com](mailto:marketing@tayg.com) | [www.tayg.com](http://www.tayg.com)





Síguenos en:



Industrias Tayg, S.L.U.  
Avda. Real de Madrid Norte, 70 - 46469 Beniparrell - Valencia (Spain)  
Tlf. +34 96 121 24 62 | marketing@tayg.com | www.tayg.com